

**FASCO**<sup>®</sup>



## FASCO FACTS

TIME-SAVING MOTOR  
REPLACEMENT TIPS



**REGAL**<sup>®</sup>

# INTRODUCTION

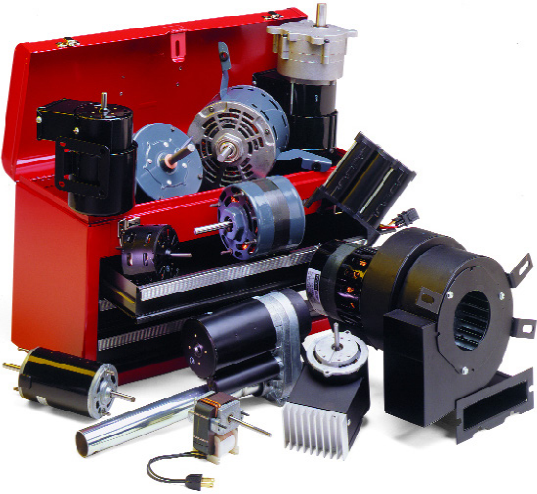

This edition of the long-standing informative Fasco® Facts booklet has been prepared by Regal as a helpful guide for the motor replacement serviceman. The goal of this booklet is to provide a better working knowledge of electric motors and related disciplines. Being better informed provides a foundation for successful motor and blower replacement.

We encourage every service person to take basic precautions for their own safety as well as their customers when installing or servicing motors. Power to the equipment must be disconnected while the unit is being serviced and all electric motors should be grounded. The National Electrical Code and local electrical and safety regulations should be followed at all times.

There are several types of fractional horsepower motors. Each type performs certain jobs better than the other types. The characteristics of a motor designed to move air are completely different than those of a motor used to drive a grinder, a pump, or even a belt-driven application.

The Regal owned brand, Fasco, manufactures permanent-split capacitor and shaded-pole motors. These motors are normally used with a fan blade or a blower wheel to move air. They are used in applications associated with heating, air conditioning, refrigeration and ventilation.



# CONTENTS

Introduction .....	2
Power Supplies .....	3
Frequency .....	4
Motor Types .....	4
Motor Frames .....	6
Motor Enclosures .....	8
Motor Bearings .....	9
Thermal Protectors .....	11
Lubrication .....	13
Capacitors .....	14
Condensation and Drain Plugs .....	16
Motor Stacks and Windings .....	17
Horsepower .....	19
Load Factor .....	20
Mechanical Characteristics .....	21
Motor Speed .....	22
High Slip Motors .....	24
Rating Motors With BTUs .....	25
Cooling Motors .....	26
Motor Temperature .....	27
Speed Controls .....	30
Removing Motors .....	30
Motor Replacement .....	31
Motor Selection .....	32
Motor Selection Verification .....	33
Motor Wiring and Rotation Reversing .....	35
Motor Installation .....	38
Mounting Motors .....	39
Contactors VA Rating .....	41
Induced Draft Blowers .....	42
Blower Wheels and Fan Blades .....	43
Fan Laws .....	45
Glossary .....	47
Notes.....	53

# POWER SUPPLIES

Voltages that power motors are either alternating current (AC) or direct current (DC). Direct current provides a current flow in only one direction. It is derived from the alternating current. The alternating current simply is electronically routed to pass through a load in only one direction. Direct current is commonly used in applications that require adjustable speed, as in production line conveyors. The properties of DC motors, combined with the ease at which direct current voltage can be created and adjusted, makes this type of drive system very popular. Alternating current, on the other hand, provides current that flows in a forward and reverse action. It does this 60 times per second in the case of 60 hertz power. This power is either single phase or 3 phase. Some common voltages used for motors are shown below.

Single Phase Voltages	3 Phase Voltages
115	208
208	230
230	460
240	480
460	
480	

The flow of electric current can be compared to water flowing through a hose. Voltage is the measure of electric force in the power supply as the water pressure is the hydraulic force in the hose.

The replacement and original motor voltages must be identical. That is, 115 volts to 115 volts, 230 volts to 230 volts, etc. There is a voltage tolerance of +/- 10%, so a 230 volt motor will operate satisfactorily on a 208 volt application and vice versa.

- Some older motors will be stamped 220 volts. In this instance, either a 208 or 230 volt motor can be substituted.
- Oil and gas furnace direct drive blower motors are usually 115 volts.
- Electric furnace direct drive blower motors are usually 230 volts.
- Condenser fan motors for residential air conditioning units can be 208, 230, 277, or 460 volts.

# FREQUENCY

The frequency rating of a power supply determines in part the speed at which the motor will run. Frequency controls the RPM of the rotating magnetic field which is what the rotor follows. The formula for calculating motor RPM is:  $RPM = (120)(\text{Frequency})/\text{Number of poles in the motor}$ . Note: 120 is a constant value.

## Motor Types .....

The most commonly encountered air-moving motors are Permanent-Split Capacitor and Shaded-Pole types. On the outside, these two motor types look very much alike. Sometimes, it may be necessary to disassemble the motor to be replaced to properly identify its type. This is easily accomplished by removing the thru bolts or clips, and tapping the end shields off of the motor shell gently with a hammer or other tool.

### Shaded-Pole (SP)

**Fact:** Used where low cost and low starting torques are required. They are used to drive blowers, bathroom ventilators, range hoods, attic ventilators, down draft blowers, fan coils, etc.



**Fact:** A Shaded-Pole motor can be recognized by the readily identifiable individual stator coil windings and the single copper band (shaded coil) formed around one side of each stator pole.

**Fact:** Shaded-Pole motors rotate toward the shading band.

### Capacitor Start

**Fact:** A higher starting torque motor than the split phase motor. It is constructed similar to the split phase motor (see page 5). The key exception is that the capacitor start motor has a capacitor in series with the start winding to increase the start torque. The capacitor is usually visible and mounted on motor frame. Used in hard-to-start applications such as compressors and pumps.



# MOTOR TYPES *(continued)*

## Permanent-Split Capacitor (PSC)

**Fact:** Used where higher starting torques are needed than what a shaded-pole motor will provide. They are also used where higher efficiency motors are required. Due to their efficiency, they have become the motor of choice versus a shaded-pole design. They are used to drive blowers and all the other air-moving applications where shaded-pole motors are found. They also are manufactured in higher horsepower ratings than what can be found in shaded-pole designs. Therefore, they get used in heavier duty applications such as outside condensers.



**Fact:** A PSC motor can usually be recognized by the capacitor that is connected to it. Also, between the main pole windings in the motor there are pole windings of finer wire. These are auxiliary windings.

## Split Phase

**Fact:** Higher starting torque motors than a PSC. Suitable for belt drive furnace blowers and belt drive ventilators. They are more efficient than Shaded-Pole motors but not as efficient as a PSC motor. These motors have more narrowly set RPM ratings. They are usually rated at 3450, 1725, and 1140. They are not constructed to provide the wide-range of multi-speeds as seen in shaded-pole and PSC motors. Multi-speed split phase motors are commonly built using separate windings to provide multiple speed options. This assures the speed-sensitive start switch will operate correctly in the motor.



## 3 Phase

**Fact:** The most efficient general purpose motor. They are used in industrial or large commercial applications where three phase power is available.



# MOTOR FRAMES

A motor frame type is a designation that a manufacturer assigns to a motor to describe certain construction parameters the motor will be built to meet. Any motors labeled with a common frame type will be built with a similar set of parameters such as motor diameter. A frame type will mandate that a motor meet certain design parameters.

For example, in the case of integral horsepower motors, manufacturers typically adhere to the NEMA® National Electrical Manufacturers Association standards. These standards chart out many design parameters such as what size shaft the motor must have or how the holes in the mounting base will be spaced apart. Motors that are not built to NEMA specifications, as is the case with the majority of air-moving fractional horsepower motors, are designed to frame types that the manufacturers create. These frames usually control fewer parameters as compared to NEMA types, since so many of the subfractional motors have custom features. Fasco frame types are listed below.

Fasco® Frame Type	Motor Diameter
C-Frame	N/A
3.3"	3.3"
38	4.4"
42	5.0" or 5.1"
48	5.625"

## Shaft Orientation Shaft Up

**Fact:** This style has venting holes in the end shield opposite the shaft end. It also has vent holes in the outer shell. These holes on the outer shell may either go around half of the motor's circumference or completely around it. This motor is generally used in applications where the motor is mounted vertically with the shaft pointing up. It can be used in horizontal applications as long as the particular model has outer shell holes only halfway around the circumference so they can be positioned beneath the motor. This will prevent rain from entering. The fan blade is mounted to the motor and usually blows air away from the shaft end. This air flow is vital to the motor as this is what cools it.



## Shaft Down

**Fact:** This style has venting holes in the end shield on the shaft end. It will also have vent holes in the outer shell. These holes on the outer shell may either go around half of the motor's circumference or completely around it. This motor is generally used in applications where the motor is mounted vertically with the shaft pointing down. It can be used in horizontal applications as long as the particular model has outer shell holes only halfway around so they can be positioned beneath the motor. This will prevent rain from entering. The fan blade is mounted to the motor and usually blows air toward the shaft end. This air flow is vital to the motor as this is what cools it.





# MOTOR ENCLOSURES

## Motor Enclosures Totally Enclosed Non Vented (TENV)

**Fact:** This style has no venting holes in the end shields or the motor shell. This motor is used in applications where the motor is mounted either vertically or horizontally. It relies on the fan blade to blow air over it.

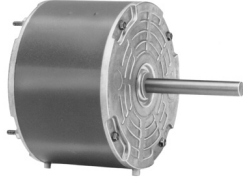

## Maximum Ventilation (OPEN)

**Fact:** These style motors have ventilation holes around the outer shell of the motor, as well as vented end shields. This design allows air to circulate freely over the winding. Care must be taken not to allow rain water to enter these motors. Some of these have only half of the perimeter vented to allow a horizontal mounting while protecting the windings from rain.

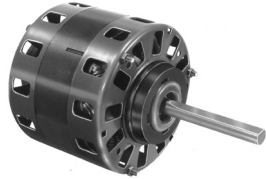

## Totally Enclosed Fan Cooled (TENV)

**Fact:** This motor has no vent holes in the end shields or outer shell. Cooling is accomplished by the use of an outside fan blade mounted to an extended motor rear shaft. The blade has a cover that directs its air over the shell of the motor.



## Open Drip-Proof (ODP)

**Fact:** This motor is self-cooling since it has an internal cooling fan. It has vent holes in the end shields and the outer shell in a limited amount. This prevents water from dripping or rain from entering the motor.



# MOTOR BEARINGS

The motor bearing allows the motor to turn freely while it supports the shaft, the rotor and the load, such as a fan blade, blower wheel, or pulley.

The most common bearings used in small FHP electric motors are sleeve bearings. For loads below 1/5 horsepower, these bearings are usually self-aligning. For loads above 1/5 horsepower, the bearings are usually babbitt-lined, steel-backed sleeve bearings, pressed into the end shield.

**Fact:** A unit bearing is a single sleeve extending into and supporting the rotor/shaft assembly. These are limited to use in low horsepower motors where light load capacity is required. They are popular in commercial refrigeration evaporators.

**Fact:** Self-aligning spherical bearings are quiet, inexpensive and have a long-life capability. They are generally used on motors that have diameters less than 5". They are designed for relatively light loads. These bearings are made of sintered bronze or iron. They are spherical shaped and sit in cups formed in the motor end shields. They are held in the cups using retainers.

**Fact:** Ball bearings are made with hardened steel balls, held in place between grooved inner and outer steel races. Ball bearings are used when heavy radial (side) thrust loads are encountered, such as a belt driven application. They are also used where the bearings must endure high temperature due to ambient or heat conducted along the shaft. They are noisier than sleeve bearings. Therefore, they are rarely used for residential applications. They are also used in applications where the RPM can fall well below 500 RPM. Sleeve bearings can actually lose their oil because it will seep out between the shaft and bearing when a shaft spins very slow.

**Fact:** Babbitt-lined, steel-backed sleeve bearings are quiet, long life bearings capable of operating heavier direct drive air-moving loads. They are most frequently used in motors with diameters exceeding 5". These bearings are pressed into die-cast aluminum end shields. Due to the solid contact with the end shield, they dissipate heat better than self-aligning bearings. At speeds below 500 RPM, oil can seep out between the shaft and bearing, causing severe loss of lubricant. At speeds higher than approximately 500 RPM, the oil will be returned to the wicking where it again will be circulated through the system. This slow speed condition is usually caused by what is known as windmilling. Windmilling is a situation where, for example, a warehouse side wall ventilator, while shut off, slowly spins due to outside wind blowing through it.



**Fact:** You can substitute ball bearing motors for sleeve-bearing motors if noise is not a concern. However, if the defective motor is of the ball bearing type, you should use a ball bearing motor as a replacement.

**Fact:** Sleeve bearings, under normal operating conditions, will last as long or longer than ball bearings.

**Fact:** Bearing temperatures are a major factor in determining the useful life of a motor. The following are some typical expected life hours at various bearing temperatures.

See chart below.

SLEEVE BEARING		
Bearing Temperature		Expected Motor Life (Single Oiling)
104° F	40° C	100,000 hours
120° F	49° C	50,000 hours
140° F	60° C	40,000 hours
160° F	71° C	30,000 hours
180° F	82° C	20,000 hours

BALL BEARING		
Bearing Temperature		Expected Motor Life
104° F	40° C	80,000 hours
120° F	49° C	40,000 hours
140° F	60° C	20,000 hours
160° F	71° C	10,000 hours
180° F	82° C	6,000 hours
200° F	94° C	4,000 hours
212° F	100° C	3,000 hours

**NOTICE**

Do not substitute ball bearing motors for sleeve-bearing motors if noise will be a problem.  
 Use ball bearing motors in high temperature applications.  
 If there is a chance that the fan will windmill, use a ball bearing motor.

# THERMAL PROTECTORS

Thermal protectors (overloads) protect the motor's insulating materials from excessive heat. Examples of these materials are winding varnish, slot liners, and lead wire insulation. Overloads have bi-metallic strips with contacts on them that act like an on/off switch in the motor. The strips "feel" the amount of heat present in the motor. When the heat is excessive, as in the case with an overloaded motor, the strips will bend and open the circuit to the motor. The overloads sense this heat in 1 of 2 ways: they either get placed right on the winding to sense the heat directly or they get mounted remotely in the motor's conduit box, for example. In a conduit box the overload has an extra component called an internal heating element. This element will create its own heat in the overload since it is not on the winding.

Some common types are described below.

**Auto reset overload** - This will automatically re-energize the motor after the motor cools down.

**Manual reset** - This will normally have a reset button that needs to be manually pressed to re-energize the motor.

**One shot** - This type will not reset. The motor will need to be replaced.

**Impedance** - This provides protection by way of the motor's inherent design which prohibits it from being able to generate excessive heat.

**Fact:** Overload protection is a requirement of Underwriter's Laboratories (UL) certification. The actual operation of an overload is intended to protect the motor winding from overheating.

**Fact:** All Fasco® motors are manufactured to an exact insulation specification and include some kind of inherent or built-in protection against overheating. The insulation system defines maximum allowable winding temperatures. The thermal protection is calibrated to the winding temperature to detect overload conditions.

**Fact:** Be sure to disconnect the motor from the line before servicing, as the motor can suddenly re-start as it reaches the temperature needed for the overload to reset.



**Fact:** “Trip and reset” cycling of the thermal protection is one of the most common application problems for both PSC and Shaded-Pole motors. It generally indicates overheating of the motor due to misapplication. It is rare to have a defective protector. Usually, one of the following conditions exists:

1. Motor is overloaded - amp draw will be 10% or more greater than the nameplate amps.
2. Motor is underloaded - amp draw will be 25% less than nameplate.
3. A defective or incorrectly sized capacitor is being used.
4. Replacement motor has less ventilation than the original motor. Less motor ventilation can cause the motor to trip on the overload but it can take considerable time to reach this point. A high ambient temperature and/or exposure to sun are a couple of reasons the trip time can be shortened.

**Fact:** Condition one and two from above can be confirmed by checking the ampere draw of the motor using an ammeter. Condition three’s defective or wrong size capacitor will cause a motor to act as if it is overloaded. It will run slow, hot, and draw more than nameplate amps. If all else checks out OK, condition four suggests the application receive a motor with similar ventilation as the original.

**Fact:** Cycling on overload is probably a misapplied motor. Current draw should not vary from the nameplate amps by more than 10% or less than 25%.

**Fact:** Do not by-pass (jump) thermal protectors to eliminate nuisance trips. Check the application.

**Fact:** An overloaded motor always runs hot, slow, and draws more than nameplate amps. Reading the motor current draw with an ammeter is the most accurate method of identifying an incorrect replacement.

# LUBRICATION

There are two types of lubricating systems for FHP motors in common use today: Wool Felt and Permawick.

**Fact:** Wool Felt: The felt is saturated with a specific amount of oil and is fitted around the bearing. This was the system originally used in all small motors and has good oil retention characteristics.

**Fact:** Permawick: A blend of cellulose fiber and turbine oil - it has the appearance of oil-soaked sawdust and has the advantage of holding 30% more lubricant than the Wool Felt system. This is the material used in all Fasco® motor bearing systems.

**Fact:** For routine maintenance and improved bearing life expectancy, a few drops of non-detergent "twenty weight" oil can be added every 12 months.

**Fact:** Oil provides a cushion, or layer between the motor shaft and bearing ID. Theoretically, the shaft and bearing do not touch. When the oil supply fails, metal-to-metal contact quickly causes bearing wear, bearing noise develops, or the shaft locks.

**Fact:** High operating temperatures for a motor will result in oil oxidation and evaporation causing eventual seizing between the bearing surface and the shaft. This frequently occurs when the motor is started after several months of not being in use. A few drops of oil at the beginning of the heating or air conditioning season is helpful.

**Fact:** A ball bearing uses special greases as the lubricant. The bearing may be sealed against contaminants. Therefore, ball bearings are also commonly found in applications where duty requirements or extreme temperatures make re-lubrication impractical.

# CAPACITORS

All PSC motors are designed to be used with an external capacitor. This capacitor operates in the circuit continuously. It is commonly referred to as a run capacitor. The most common capacitor for fan/blower motors is 5 Mfd., 370 volt. However, other ratings will also be used depending on the model.

**Fact:** A capacitor is a device capable of storing and releasing an electric charge.

**Fact:** Always discharge a capacitor before removing it from an installation.

**Fact:** The capacitor used with a capacitor start motor is called a start capacitor because it is used only while the motor is starting.

**Fact:** The capacitor rating is printed on the capacitor itself, the motor nameplate or the system wiring diagram. You must know this rating to properly choose the correct replacement capacitor.

**Fact:** Capacitors are rated by both capacity (2 Mfd, 5 Mfd., etc.) and voltage (370 volt, 440 volt, etc.). The rated capacitor size should not be changed, since the motor operates at maximum efficiency when using the specified capacitor size. If necessary, the replacement capacitor voltage rating can be higher than specified, but not lower without impairing capacitor life.

**Fact:** Capacitors can be hooked up in parallel to increase capacity. For example, two 5 Mfd., 370 volt capacitors connected in parallel are the equivalent of a 10 Mfd., 370 volt capacitor. See illustration below.

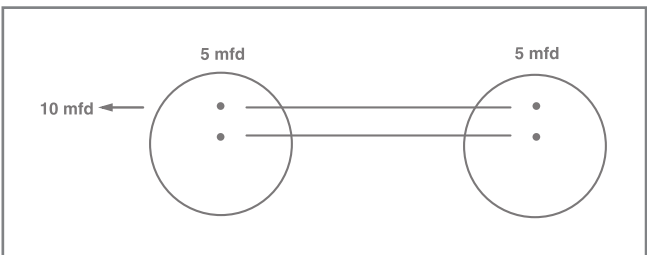
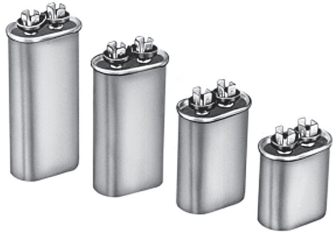

## CAPACITORS *(continued)*

**Fact:** Capacitor life is about 60,000 hours, continuous operation, at rated voltage and maximum case temperature of 70 degrees C (158 degrees F). All Fasco® PSC motor nameplates include a wiring diagram, and normally the capacitor is connected to the two brown leads.

**Fact:** Replace the capacitor when replacing a defective motor. If a defective capacitor is in the circuit, the motor probably will not run. If it does run, it will operate as if overloaded. The motor speed will be low, and it will overheat and probably trip the overload protector.

### **⚠ WARNING**

A high-quality capacitor can hold a charge for long periods of time. To prevent a painful shock, the capacitor should be discharged before its removal.

**Fact:** There are two safe ways to test capacitors in the field:

1. A capacitor tester can be used. It needs to provide readings in microfarads.
2. An ohmmeter can be used. If the capacitor is taking a charge, the ohmmeter reading will move toward "0" ohms (closed circuit) and hold at that point, then slowly move back toward infinity (open circuit). This is an indication of a good capacitor. Charge the capacitor. If it is failed open, the ohmmeter reading will stay at infinity.

**Fact:** Always check the capacitor before replacing a PSC motor.

**Fact:** A motor with a shorted capacitor can still start and run, but will operate as if seriously overloaded.

**Fact:** This is a quick tip for distributors who bench test motors before handing them over to customers. When finishing your test, be sure to discharge the capacitor with an appropriate resistor such as a 15 Kohm 2 watt resistor. Depending how the motor leads are connected, it may discharge through the windings when the motor is de-energized.



### **Series connection:**

If, for example, two 5 Mfd., 370 VAC capacitors are wired in series, the following formula will show equivalent capacitance and voltage rating they produce when connected this way.

$$\begin{aligned}\text{Mfd.} &= 1 / (1/\text{Capacitor one}) + (1/\text{Capacitor two}) \\ &= 1/(1/5 + 1/5) \\ &= 2.5 \text{ Mfd.}\end{aligned}$$

The two 370 VAC capacitor ratings add together in a series connection giving 740 VAC total capability. (voltages only add like this if the capacitors are the same capacitance.)

### **Parallel connection:**

If the two capacitors are wired in parallel the following formula will show the Mfd. result.

$$\begin{aligned}\text{Mfd.} &= \text{Capacitor one} + \text{Capacitor two} \\ &= 5 + 5 \\ &= 10 \text{ Mfd.}\end{aligned}$$

In a parallel connection, the two 370 VAC capacitor ratings do not add together, so the total capability is still 370 VAC.

## **Condensation and Drain Plugs.....**

**Fact:** Differences between daytime and night time temperatures can create condensate in totally enclosed motors. A drain hole should be at the lowest point in the motor to permit the condensate water to exit.

**Fact:** Certain Fasco® motors are designed to be used in outside applications as with condensers, for example. Motors used in these condensers may be totally enclosed non-vented. When replacing these motors with Fasco motors, be sure to pull the blue condensation plug on the Fasco motor, on the end that will point down. By pulling the drain plug, the condensation that builds up in the motor can drain properly.

**Fact:** Remember that Fasco has two colors of plugs on the motors. The blue plugs are condensation drain plugs and the yellow plugs are for re-oiling.

# MOTOR STACKS AND WINDINGS

**Fact:** A motor of the same diameter and stack can be substituted when neither the HP or ampere rating of the defective motor is known. The stack of a motor is the width of the stator iron laminations. This is a very rough measurement to be used as a last resort in selecting a replacement motor.

**Fact:** The reason a stator is made of individual laminations is basically to reduce the electrical losses due to circulating currents that occur in the iron. These are called eddy currents. These are caused by the magnetic flux created by the windings. Laminating this core greatly reduces these losses.

**Fact:** Most open circuits in the windings resulting from defects in the motor windings occur within the first two hours of operation. This is the time required to reach maximum temperature rise. Most short circuits in windings occur if the motor windings are wet when the motor is operating or if lightning strikes. Usually shorts are not a result of motor overheating, since the motor is thermally protected.

**Fact:** Why are there different size wire and different number of turns in windings? Because the torque output of a motor depends on the strength of the magnetic fields created by the poles in the stator. The stator's size of wire, number of turns, and stack height determine the strength of these magnetic fields.

**Fact:** The number of similar coils visible in the stator winding equals the number of poles. Efficiency of a motor is a measurement of the useful work performed by the motor versus the energy it consumes. The input power in watts is the product of the voltage times amps times the electrical efficiency. The power it puts out is done through the spinning motor shaft. The output power in watts is

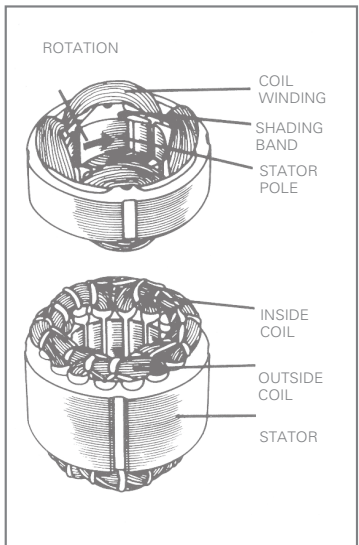



the input watts times the mechanical efficiency. The ratio of input to output is the motor efficiency. For example, a motor with 100 watts input and an output of 50 watts is 50% efficient. The watts lost are heat which needs to be dissipated from the motor.

**Fact:** A Shaded-Pole motor is the least efficient design. It is approximately half as efficient as a PSC motor. A Shaded-Pole motor draws about twice the amps of a PSC motor of the same horsepower. For example, if a Shaded-Pole motor consumes 300 watts and is only 35% efficient, its work output would be only 105 watts, but it is less costly than the PSC design.

**Fact:** When replacing motors, it is best to match motor type. A PSC motor can be used to replace a Shaded-Pole motor; however, the reverse is not true. The PSC motor will be twice as efficient as the Shaded-Pole motor and draw about half the amps. The greater efficiency of the PSC motor permits lower operating costs and lower temperature rise. Replacing a PSC motor with a Shaded-Pole motor is not recommended. Increased ampere draw could cause the line fuse to trip.

**Fact:** Multi-speed motors are less efficient than single-speed motors, due to space limitations for the windings.

**Fact:** An overloaded motor is one that is too weak for the job. Its speed will be low, its amperage draw is more than 10% above the nameplate rating, and it will have increased heat rise. Its motor life will be reduced.

**Fact:** An underloaded motor is one too strong for the job. Using too strong a motor for a replacement is evident when its amperage draw is 25% less than the nameplate reading. Using a motor with excessive horsepower can also cause increased heat rise due to decreased efficiency. Over motoring an application increases RPM very little. In most cases RPM for a six pole motor designed to operate at 1075 would only increase by 50 RPM if the motor's power was doubled.

**Fact:** Some energy-efficient motors will have matching horsepower but lower amps.

# HORSEPOWER

**Fact:** When a motor is to be replaced, select a motor with adequate power output. Horsepower is the usual measurement of power output. This rating is normally stamped on the nameplate. Motors with horsepower ratings below one horsepower are called fractional horsepower motors.

**Fact:** Horsepower requirements vary with the cube of the speed in air moving applications. In other words, replacing a six pole motor with a four pole requires the four pole motor to have more than three times greater horsepower.

**Fact:** When replacing motors, the horsepower of the defective and the replacement motor should be the same. In motors rated below 1/4 HP, or when the HP rating is not available, matching the current rating is a satisfactory procedure. Do not use a replacement motor whose nameplate ampere rating is less than the defective motor. The replacement motor may have nameplate amps 25% greater than the nameplate amps of the defective motor. Some newer designs may have lower amps per HP rating if they are very efficient.

**Fact:** It is possible to match horsepower ratings by measuring the stack width of the stator laminations in the defective motor and then use a replacement motor with the same stack.

**Fact:** Replacement by the use of a larger horsepower may cause the motor to be underloaded. It could eventually overheat and cause overload trips. The actual ampere reading will be below the full load amp rating on the nameplate.



# LOAD FACTOR

Load Factor describes how much extra horsepower is built into a particular motor at its nameplate RPM that is beyond its nameplate HP rating. It is the ratio of tested horsepower to nameplate horsepower. The following is a more detailed explanation.

Load Factor is arrived at by the following sample calculations.

For example:

A stock condenser fan motor has a nameplate rating of 1/4 HP (0.25 HP) and 1075 RPM. If we test the motor on a dynamometer, we find that the torque produced at 1075 is 19.05 in. lbs.

We next calculate the horsepower using the test data. We find,

$$\begin{aligned} \text{HP} &= N \times T/K \\ &= (1075 \times 19.05) / 63025 \\ &= 0.325 \text{ HP} \end{aligned}$$

This is almost 1/3 HP!

Now to calculate the Load Factor, we simply divide the ratio of tested horsepower to nameplate horsepower.

$$\begin{aligned} \text{Load Factor} &= 0.325 / 0.25 \\ &= 1.3 \end{aligned}$$

The Fasco® catalog would show a Load Factor of 1.3 in the chart. Load Factor should not be confused with the common motor term called Service Factor. Service Factor pertains to self-cooled motors, such as the ones designed in accordance with NEMA® standards. Service Factor is the percentage over nameplate horsepower that a particular motor can be operated at while being sufficiently self-cooled. For example, a 1.3 rating relates to a 30% reserve in horsepower that can be drawn on if needed. This is useful when intermittent overloads will be encountered.

Fasco motors designed with a Load Factor provide value to your customers since you are promoting a motor with extra margin to handle tough applications. A tough application, for example, is where an OEM used a marginally designed motor with just enough horsepower to get by. By selling a Fasco replacement with a Load Factor, you can promote the installation of a motor better suited for the job.

# MECHANICAL CHARACTERISTICS

**Fact:** When replacing motors, important mechanical features must be identified. The replacement motor should be about the same diameter and length as the replaced motor, so it can be installed in the existing mount. This section will discuss the problems encountered in motor mountings and some solutions to these problems.

**Fact:** The most common motor diameters the service person will encounter are 3-1/3", 4-7/16", 5" and 5-5/8".

**Fact:** Motor shaft dimensions must match in diameter and length. All Fasco® distributor models that are not direct OEM replacements have long shafts so they can be cut to length. The OEM direct replacement models have shafts cut to the exact OEM length, so those shafts may be shorter than the models in the general line.

**Fact:** When modifying a motor shaft, make certain the shaft is tightly held in a vise to avoid stress on the motor bearings.

**Fact:** When cutting a shaft to length, it is extremely important to prevent steel filings and/or shavings from entering the motor.

**Fact:** Make sure no metal burrs are left on the shaft after it is cut. If these are not removed, it may be difficult to fit the fan blade or wheel onto the shaft.

## ⚠ CAUTION

Wear safety glasses while modifying a shaft to protect your eyes from sharp metal filings.

**Fact:** If the motor to be replaced has a different shaft diameter than the replacement motor, Fasco shaft bushings can sometimes be used. The most commonly available sizes are:

- 1/4" ID x 5/16" OD, Kit 240
- 5/16" ID x 3/8" OD, Kit 244
- 3/8" ID x 1/2", Kit 242
- 1/2" ID x 5/8" OD, Kit 246



**Fact:** There are a few common ways contractors shorten motor through-bolts when it is necessary to properly install a motor. Whether they snap them off with a hollow nut driver or cut them off with small bolt cutters, it is always good to first spin on an extra nut all the way down to the face of the motor. After the bolt is shortened, the nut should be unscrewed off the through bolt. Taking the nut off will reshape the starting thread which usually gets damaged when the bolt is cut or broken off. This makes it much easier to start the nuts when the motor is mounted.



# MOTOR SPEED

The base speed of a motor is determined by the number of poles. The number of wound coils in the motor equals the number of poles.

**Fact:** Multi-speed motors will only indicate speed variations when loaded. When run without a load, a motor will run at a single unchanging speed.

**Fact:** PSC motors require auxiliary windings. These get positioned between the main windings. Only the main windings should be counted for the speed calculation.

**Fact:** It is important that a six-pole motor be replaced with a six-pole motor, a four-pole be replaced by a four-pole and so on, for two reasons:

1. Replacing a four-pole motor (1400 to 1650 RPM) with a lower speed six-pole motor (900 to 1150 RPM) results in reduced air delivery and greatly reduced system efficiency can be enough to automatically shut down the system.
2. If a six-pole motor is replaced with a four-pole as in a condenser, the motor will be seriously overloaded, causing cycling on the motor's overload protector.

**Fact:** Modern multi-speed motors are really not multi-speed, but multi-horsepower. The speeds are simply taps at different points in the coil. The higher speeds are tapped at a point with fewer turns as compared to where the subsequent speeds are tapped in the same coil. The more turns that are wound before a tap is brought out, the lower the horsepower will be each time. Obviously, the lowest speed lead is connected to the end of the last turn on the coil. These added turns weaken the motor. This field weakening allows the load to slow the motor down each time a slower speed is selected. With no load mounted on the shaft, as with a bench test, no difference between speeds will be seen. If too strong a replacement motor is used on a unit, there may be no appreciable difference when the speed is changed in the unit. Remember, the motor relies on the load to slow it down between the speeds. As an example, if a 1/2 HP three speed motor is used instead of a 1/4 HP three speed, there might not be any noticeable difference between Hi, Med, and Low.

**NOTE: A motor nameplate showing 1350 RPM is a special design and must be replaced with an OEM direct replacement. This is a high slip 4 pole motor, which is not generally available in a general line of motors. If one is available, it would be marketed as an OEM direct replacement motor for a specific piece of equipment. These motors are specially designed for a very specific load.**

# MOTOR SPEED *(continued)*

**Fact:** Multi-speed motors can be used in single-speed applications. Looking at a typical multi-speed, 1/3 horsepower motor, we would find a 1/3 horsepower rating on high speed, 1/4 horsepower on medium, and 1/6 horsepower on low speed. By taping the leads individually of the two speeds you do not need, you can have a single speed 1/6 HP, 1/4 HP or 1/3 HP motor.

**Fact:** In replacing blower motors, air volume and direction must match the original installation. This air movement is a result of the motor speed and the blower size. Assuming only the motor will be replaced, it must have the same speed as the defective unit.

**Fact:** Motors with nameplate speeds in the range of 1300 - 1400 RPM are high slip motors and need a direct OEM replacement motor.

**Fact:** Multi-speed motors may be used to replace a single-speed motor. Leads not used should have the ends individually insulated.

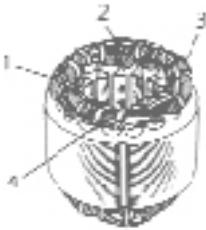

**Figure 1**  
Permanent-Split  
Capacitor Motor Coils



**Figure 2**  
Shaded-Pole  
Motor Coils

Figure 1 is a Permanent-Split Capacitor motor with four wound coils and is a four-pole motor.

Figure 2 is a Shaded-Pole motor also with four wound coils. It is also a four-pole motor. A Permanent-Split Capacitor motor requires auxiliary windings positioned between the main windings (only the main windings are counted for speed calculation).

Number of Poles	Normal High Speed
2	2800 to 3200 RPM
4	1400 to 1650 RPM
6	900 to 1150 RPM
8	800 to 850 RPM





## HIGH SLIP MOTORS

Some motors found on OEM equipment have RPM ratings in the 1300 to 1400 range. These non-conventional motors are called high slip four-pole motors. Conventional four-pole PSC motors generally run around 1625 RPM and six-pole motors run around 1075 RPM. High slip four-pole motors offer a slower running motor than 1625 but faster than six-pole 1075 RPM. This gives the OEM the best of both worlds. It offers a quieter motor than a 1625 RPM and faster than a 1075 RPM.

The term slip refers to the difference between the speed of the rotating magnetic field and the actual speed of the rotor in the motor. A four-pole rotating magnetic field spins invisibly at 1800 RPM with 60 Hz. power applied to it. This field drags the rotor along at a speed less than 1800 RPM. It spins slower and will never catch up. It can run at 1550 or 1625 RPM, for example. Remember to never replace a high slip motor with a conventional speed motor. For example, never replace a 1350 RPM high slip motor with a conventional 1625 RPM motor. The reason is straightforward. Spinning fan blades or wheels in equipment that run faster than they were designed for will require a new HP calculated similar to this example.

Example:

A customer has a failed motor that was spinning a fan blade. The motor was rated at 1/2 HP, 1350 RPM. If a conventional 1625 RPM motor is used, what HP will be needed?

$$\begin{aligned}\text{New HP} &= \text{Old HP}(\text{New RPM}/\text{Old RPM})^3 \\ &= 0.5(1625/1350)^3 \\ &= 0.5(1.2)^3 \\ &= 0.86 \text{ HP}\end{aligned}$$

This is well over 3/4 HP (3/4 = 0.75)! Increasing the speed would also negatively affect the total system performance. Stick with the original RPM.

# RATING MOTORS WITH BTUS

The following helpful guides have been used successfully to approximate the motor horsepower, based on BTU rating of a window air conditioner. This is for cases where the motor nameplate has no horsepower listed. Notice that some horsepower ratings overlap. For example, you might find a 1/10 or 1/8 horsepower motor in a 10,000 BTU window air conditioner. Please keep in mind that there will be exceptions to these guides.

## Window Air Conditioner

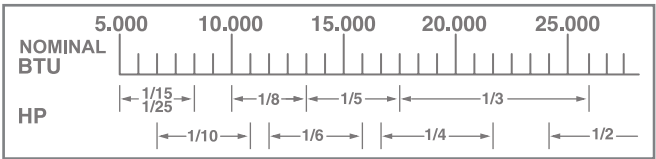

There are 12,000 BTUs in one ton of air conditioning.

A similar system can be used to approximate the motor based on the rating of a central air conditioning system.

## Central A/C System Condenser Fan Motors

System	HP
2 Ton	1/5
2 1/2 Ton	1/4
3 Ton	1/3
3 1/2 Ton	1/2
4-5 Ton	3/4
7 1/2 Ton	1



## COOLING MOTORS

Fractional horsepower air-moving motors, which are motors with blower wheels or fan blades mounted to them, require the air that they move to be passed over the motor. This is the way these motors stay cool. Without it, they will overheat.

In a mechanical application such as a conveyor, these motors will either have an internal or external cooling fan. These fans are needed to cool the motor since they are not in an air stream.

**Fact:** Most PSC and Shaded-Pole motors are used to drive fan blades or blower wheels which are directly attached to the motor shaft. They are primarily air-moving motors. The motor must be located in the air stream created by the fan or blower to run cool.

**Fact:** PSC and Shaded-Pole motors not moving air or not located in the air stream are called mechanical duty motors, and may require an internal fan inside the motor to provide cooling air.

**Fact:** A motor enclosure is designed to provide maximum air flow within and around the motor for cooling and, at the same time, provide protection from moisture, dirt, etc. which might cause electrical or mechanical failure.

**Fact:** Replacement motors for outdoor condenser fans often require a rain shield to reduce the chance of water getting into the motor. Regal has rain shields for motors with 1/2" and 5/8" diameter shafts.

**Fact:** Always try to match the replaced motor's ventilation system. Inadequate cooling in the motor will cause overheating and cycling on overload.

# MOTOR TEMPERATURE

Temperature rise in a motor describes the temperature of the motor winding compared to the temperature of the surrounding air. The surrounding temperature is called the ambient temperature. The amount of temperature rise over ambient is important because the insulation used in the motor is rated to withstand a specific level of heat before its insulating properties degrade. To help prevent this from happening, motors have thermal protectors. They will disconnect the power from the motor if it reaches the maximum temperature. Another term used to describe motor temperature is total temperature which is the actual temperature of the motor winding. It is the sum of the ambient temperature plus the motor's temperature rise.

**Fact:** Continuous duty motors should not operate at temperatures exceeding 100 degrees C (212 degrees F). The life of the bearings and lubrication system will be adversely affected.

**Fact:** Overheating is a sign of an overloaded or underloaded motor. Even if the motor is properly sized, it may still overheat if proper cooling air is not blowing over the motor.

**Fact:** Insulation systems are rated according to the temperature the coil windings can withstand. The two most common types of systems are Class A which can withstand a temperature of 105 degrees C (221 degrees F), and Class B which can withstand a temperature of 130 degrees C (266 degrees F). Due to their ability to withstand higher temperatures, motors with Class B insulation systems can be used to replace Class A rated motors.

**Fact:** Heat is the primary enemy of motors. Excessive heat is the sign of a misapplication. It shortens insulation life, dries out the bearing lubrication system, and causes the overload protector to trip.

**Fact:** Total motor operating temperature consists of motor temperature rise plus ambient (surrounding air) temperature. Watts (power) into a motor comes out as work and heat. A motor driving 200 watts which is 70% efficient will do 140 watts of work ( $200 \times .70 = 140$ ) and 60 watts ( $200 - 140 = 60$ ) will become heat. This heat results in motor temperature rise.

**Fact:** After two hours of operation, maximum temperature rise should be reached. Ambient temperature in a house is usually 70 degrees to 80 degrees F. When an air conditioning unit is operating, the ambient temperature in the condenser unit can range from 75 degrees to 120 degrees F.

**Fact:** It is important to understand a replacement motor's temperature limitations. The proper conversion from a degree reading in degrees F to degrees C and vice versa is important.

To make this task simple, we have provided the following conversion table.

The numbers in bold refer to the temperature to be converted. For example, to convert 77 degrees F to C, find 77 in the middle bold column. To the left of 77 will read 25 which is the degrees C conversion. To convert 77 degrees C to degrees F, read the number on the right which is 170.6, the degrees F conversion.

C°	F°	C°	F°	C°	F°	C°	F°				
-45.6	<b>-50</b>	-58	1.67	<b>35</b>	95.0	23.9	<b>75</b>	167.0	79.4	<b>175</b>	347
-40.0	<b>-40</b>	-40	2.22	<b>36</b>	96.8	24.4	<b>76</b>	168.8	82.2	<b>180</b>	356
-34.4	<b>-30</b>	-22	2.78	<b>37</b>	98.6	25.0	<b>77</b>	170.6	85.0	<b>185</b>	365
-28.9	<b>-20</b>	-4	3.33	<b>38</b>	100.4	25.6	<b>78</b>	172.4	90.6	<b>195</b>	383
-23.3	<b>-10</b>	14	3.89	<b>39</b>	102.2	26.1	<b>79</b>	174.2	90.6	<b>195</b>	383
-17.8	<b>0</b>	32	4.44	<b>40</b>	104.0	26.7	<b>80</b>	176.0	93.3	<b>200</b>	392
-17.2	<b>1</b>	33.8	5.00	<b>41</b>	105.8	27.2	<b>81</b>	177.8	96.1	<b>205</b>	401
-16.7	<b>2</b>	35.8	5.56	<b>42</b>	107.6	27.8	<b>82</b>	179.6	98.9	<b>210</b>	410
-16.1	<b>3</b>	37.4	6.11	<b>43</b>	109.4	28.3	<b>83</b>	181.4	100.0	<b>212</b>	413
-15.6	<b>4</b>	39.2	6.67	<b>44</b>	111.2	28.9	<b>84</b>	183.2	101.7	<b>215</b>	419
-15.0	<b>5</b>	41.0	7.22	<b>45</b>	113.0	29.4	<b>85</b>	185.0	104.4	<b>220</b>	428
-14.4	<b>6</b>	42.8	7.78	<b>46</b>	114.8	30.0	<b>86</b>	186.8	107.2	<b>225</b>	437
-13.9	<b>7</b>	44.6	8.33	<b>47</b>	116.6	30.6	<b>87</b>	188.6	110.0	<b>230</b>	446
-13.3	<b>8</b>	46.2	8.89	<b>48</b>	118.4	31.1	<b>88</b>	190.4	112.8	<b>235</b>	455
-12.8	<b>9</b>	48.2	9.44	<b>49</b>	120.2	31.7	<b>89</b>	192.2	115.6	<b>240</b>	464
-12.2	<b>10</b>	50.0	10.0	<b>50</b>	122.0	32.2	<b>90</b>	194.0	118.3	<b>245</b>	473
-11.7	<b>11</b>	51.8	10.6	<b>51</b>	123.8	32.8	<b>91</b>	195.8	121.1	<b>250</b>	482
-11.1	<b>12</b>	53.6	11.1	<b>52</b>	125.6	33.3	<b>92</b>	197.6	123.9	<b>255</b>	491
-10.6	<b>13</b>	55.4	11.7	<b>53</b>	127.4	33.9	<b>93</b>	199.4	126.7	<b>260</b>	500
-10.0	<b>14</b>	57.2	12.2	<b>54</b>	129.2	34.4	<b>94</b>	201.2	129.4	<b>265</b>	509
-9.44	<b>15</b>	59.0	12.8	<b>55</b>	131.0	35.0	<b>95</b>	203.0	132.2	<b>270</b>	518
-8.99	<b>16</b>	60.8	13.3	<b>56</b>	132.8	35.6	<b>96</b>	204.8	135.0	<b>275</b>	527
-8.33	<b>17</b>	62.6	13.9	<b>57</b>	134.6	36.1	<b>97</b>	206.6	137.8	<b>280</b>	536
-7.78	<b>18</b>	64.4	14.4	<b>58</b>	136.4	36.7	<b>98</b>	208.4	140.6	<b>285</b>	545
-7.22	<b>19</b>	66.2	15.0	<b>59</b>	138.2	37.2	<b>99</b>	210.2	143.3	<b>290</b>	554
-6.67	<b>20</b>	68.0	15.6	<b>60</b>	140.0	37.8	<b>100</b>	212.0	146.1	<b>295</b>	563
-6.11	<b>21</b>	69.8	16.1	<b>61</b>	141.8	40.6	<b>105</b>	221.0	148.9	<b>300</b>	572
-5.56	<b>22</b>	71.6	43.3	<b>62</b>	143.6	43.3	<b>110</b>	230	151.7	<b>305</b>	581
-5.00	<b>23</b>	73.4	17.2	<b>63</b>	145.4	46.1	<b>115</b>	239	154.4	<b>310</b>	590
-4.44	<b>24</b>	75.2	17.8	<b>64</b>	147.2	48.9	<b>120</b>	248	157.2	<b>315</b>	599
-3.89	<b>25</b>	77.0	18.3	<b>65</b>	149.0	51.7	<b>125</b>	257	160.0	<b>320</b>	608
-3.33	<b>26</b>	78.8	18.9	<b>66</b>	150.8	54.5	<b>130</b>	266	162.8	<b>325</b>	617
-2.78	<b>27</b>	80.6	19.4	<b>67</b>	152.6	57.2	<b>135</b>	275	165.6	<b>330</b>	626
-2.22	<b>28</b>	82.4	20.0	<b>68</b>	154.4	60.0	<b>140</b>	284	168.3	<b>335</b>	635
-1.67	<b>29</b>	84.4	20.6	<b>69</b>	156.2	62.8	<b>145</b>	293	171.1	<b>340</b>	644
-1.11	<b>30</b>	86.0	21.1	<b>70</b>	158.0	65.6	<b>150</b>	302	173.9	<b>345</b>	653
-0.56	<b>31</b>	87.8	21.7	<b>71</b>	159.8	68.3	<b>155</b>	311	176.7	<b>350</b>	662
0	<b>32</b>	89.6	22.2	<b>72</b>	161.6	71.1	<b>160</b>	320	179.4	<b>355</b>	671
0.56	<b>33</b>	91.4	22.8	<b>73</b>	163.4	73.9	<b>165</b>	329	182.2	<b>360</b>	680
1.11	<b>34</b>	93.2	23.2	<b>74</b>	165.2	76.7	<b>170</b>	338	185.0	<b>365</b>	689

## MOTOR TEMPERATURE *(continued)*

**Fact:** A replacement motor can be assumed to be operating successfully and with an acceptable operating temperature if it is not overloaded or underloaded, and has about the same amount of ventilation holes as the original motor.

**Fact:** The overload protector opens the electrical circuit to a motor before the winding reaches a temperature that would damage the winding insulation. The overload protector should never be removed or shorted out (jumped).

**Fact:** Heat and moisture are the two most important factors limiting motor life. Moisture can be the result of either rain, or the condensing of warm moisture inside the motor when it cools down in the evenings. Water can collect in a motor without drain holes at the lowest point, and if the coils are touched by this water, a ground or short circuit can occur.

**Fact:** An underpowered replacement is more likely to cause problems than overpowering.

**Fact:** Be careful when touching a motor as it may be at its normal operating temperature. The motor housing surface could be hot enough to cause injury.

**Fact:** The ventilation style of a motor is determined by three parts. Namely, the two end shields and the motor shell. The condenser fan blade will provide a certain amount of cooling air flow over the motor. If the OEM designs a condenser for an open ventilated fan motor and the contractor replaces it down the road with a TENV design, there is a chance that the blade will not provide enough air flow to cool the motor, since a TENV motor can require a higher amount of air flow to cool. The result can cause nuisance tripping of the motor overload. It is best to match enclosures when suggesting or installing a replacement.

**Fact:** When replacing condenser fan motors, the replacement motor should have the same nameplate horsepower as the OEM motor. Condensers are designed with a specific fan motor horsepower requirement needed to circulate the air through the coils. When a replacement motor is used that has a higher HP rating, two things result. The required amount of cooling air needed over the motor increases since the heat generated is higher. This is something that the fan blade may not be able to provide since it will be running at the same speed of 1075 RPM, for example. The second concern is that the higher HP motor will be running underloaded, which causes increased heat in a

# SPEED CONTROLS

PSC motor. The result of either of these two conditions can be nuisance tripping of the overload protector, which trips when a specific temperature is sensed in the motor windings.

A specific speed control must be tested with a specific motor. There are no general lines of speed controls that can be used across the motor offering. Each motor will respond differently. The most important test characteristic is heat rise in the motor. Some motors may overheat and trip the motor's overload. It is advisable to place thermocouples on the windings and monitor the motor's operating temperature throughout the speed range before one of these controls are used.

## Removing Motors .....

<b>⚠ CAUTION</b>
RISK OF INJURY IN REMOVING MOTORS.

1. Disconnect all electrical power from the unit. Never take chances with live wires.
2. Find the wiring diagram that shows the hook-up of all motor leads, or draw a diagram showing where each wire is going.
3. If the motor is a PSC type, note the size and location of the capacitor. Before attempting to remove or handle the capacitor, discharge the capacitor through a resistor. A capacitor can hold a charge for some time which could cause a rather harsh shock.
4. Note number of motor speeds.
5. Determine rotation by looking on the nameplate, or motor body, for arrow or rotation markings. Fasco uses CW as clockwise and CCW as counter clockwise, looking at the shaft end. Some manufacturers refer to rotation as at lead end or opposite lead end. The best method is to scratch a rotation arrow on the motor before removal.
6. Remove the motor from the unit, noting the type of motor mounting being used. For instance, resilient base, through bolts, lug mounts, band mount, etc.

# MOTOR REPLACEMENT

It is seldom that a replacement motor can be identified through the original equipment manufacturer's model number. By following a procedure that answers specific questions about the old motor, a correct replacement motor can be selected quite easily. This section will deal with these questions and ways to obtain the answers. It is always best to have the defective motor available for firsthand visual inspection and measurement. You cannot identify an unknown motor without proper information. The status of the motor being replaced should also be checked to see if it is the original motor or a previous replacement motor. The following are common questions to get answers when replacing a motor.

1. What is the application?
2. How is it mounted?
3. What type of motor is it?
4. What ventilation does it have?
5. How many speeds does it have?
6. What is the direction of rotation?
7. What is the horsepower, RPM and voltage?
8. What is the shaft length and diameter?
9. Does the motor have any special features?
10. What is the motor diameter?
11. What type of bearings does it have?
12. What is the OEM part number on it?

Take this information and the old motor to a local Fasco® distributor for a replacement.



# MOTOR SELECTION

When selecting a replacement motor using current (amp) rating comparisons, it is important to choose a replacement motor that has the correct load carrying capability. An overloaded motor will overheat causing the thermal protector to trip. Selecting too strong a motor will also cause overheating.

The table below gives the amp range of an acceptable replacement. For instance, a defective motor with a nameplate rating of 2.35 amps would be closest to 2.4 amps and can be replaced with a motor of the same voltage having a nameplate current rating between 2.4 and 3.0 amps.

Nameplate Amps of the Defective Motor	Nameplate Amp Range of an Acceptable Replacement
1.00	1.00 - 1.25
1.10	1.10 - 1.37
1.20	1.20 - 1.52
1.30	1.30 - 1.62
1.40	1.40 - 1.75
1.50	1.50 - 1.87
1.60	1.60 - 2.00
1.70	1.70 - 2.13
1.90	1.90 - 2.37
2.00	2.00 - 2.50
2.20	2.20 - 2.75
2.40	2.40 - 3.00
2.60	2.60 - 3.25
2.80	2.80 - 3.50
3.00	3.00 - 3.75
3.30	3.30 - 4.12
3.60	3.60 - 4.50
4.00	4.00 - 5.00
4.40	4.40 - 5.50
4.80	4.80 - 6.00
5.00	5.00 - 6.25
5.50	5.50 - 6.87
6.00	6.00 - 7.50
6.50	6.50 - 8.12
7.00	7.00 - 8.75
7.50	7.50 - 9.37
8.00	8.00 - 10.00
8.50	8.50 - 10.62
9.00	9.00 - 11.25
9.50	9.50 - 11.87
10.00	10.00 - 12.50
10.50	10.50 - 13.12
11.00	11.00 - 13.75
11.50	11.50 - 14.40
12.00	12.00 - 15.00

## MOTOR SELECTION *(continued)*

**Fact:** Matching ampere rating is usually more precise than matching horsepower.

**Fact:** Speed and voltage of the replacement motor must always match the speed and voltage of the replaced motor.

**Fact:** A PSC motor can replace an equivalent Shaded-Pole motor, since it is twice as efficient and its amp draw is about 1/2 as great. Shaded-Pole motors should not be used to replace PSC motors.

**Fact:** It is important to realize that motor amps are actually related to how fast the shaft is spinning at the instant a reading is taken. At the instant a motor is energized, and before the shaft even begins to spin, the magnetic flux created by the windings sweep through the rotor bars and produce currents through them. This rotor bar current produces its own invisible magnetic flux lines. As soon as the rotor begins to spin, its own magnetic flux lines will begin to cut through the motor windings. This action will generate a voltage in the winding that actually opposes the line voltage. This action actually pushes back the flow of motor amperage. As the rotor approaches full speed such as 1075 RPM, the rotor bar flux is sweeping through the winding so fast that the opposing voltage generated suppresses the motor amperage down to the nameplate rating.

## Motor Selection Verification .....

When a Fasco® replacement motor has been selected and installed, a final check of the current draw of the motor running in the unit should be made. This check is particularly beneficial when the motor in the application has been replaced before, since the previous replacement motor may not have been correct for the application. The table below will help this procedure, as it shows the range within which the motor should be operating under load. For instance, if the amps on the nameplate of the replacement motor is 1.6 and it draws 1.7 in the application, it is OK. If it draws 1.1 amps it is too strong, and if it draws 1.8 it is too weak.

Nameplate Amps of the Replacement Motor	Safe Amp Range within which the Motor can Operate in the Application
1.00	0.75 - 1.10
1.20	0.90 - 1.32
1.30	0.98 - 1.43
1.40	1.05 - 1.53
1.50	1.13 - 1.65
1.60	1.20 - 1.76
1.70	1.28 - 1.87
1.80	1.35 - 1.98
1.90	1.43 - 2.09
2.00	1.50 - 2.20
2.20	1.65 - 2.42
2.40	1.80 - 2.64
2.60	1.95 - 2.86
2.80	2.10 - 3.08
3.00	2.25 - 3.30
3.30	2.48 - 3.63
3.60	2.70 - 3.96
4.00	3.00 - 4.40
4.40	3.30 - 4.84
4.80	3.60 - 5.28
5.00	3.75 - 5.50
5.50	4.13 - 6.05
6.00	4.50 - 6.60
6.50	4.88 - 7.15
7.00	5.25 - 7.70
7.50	5.63 - 8.25
8.00	6.00 - 8.80
8.50	6.38 - 9.35
9.00	6.75 - 9.90
9.50	7.13 - 10.45
10.00	7.50 - 11.00
10.50	7.88 - 11.60
11.00	8.25 - 12.10
11.50	8.63 - 12.70
12.00	9.00 - 13.20

After the replacement motor has been installed and the system turned on, the unit should be monitored for about 2 hours to make certain no unusual condition appears.

Motor shafts should rotate freely when checked by hand. If a motor shaft is tight, tap lightly on the motor with a non-metallic mallet, or loosen the thru-bolts, then re-tighten.

# MOTOR WIRING AND ROTATION REVERSING

Motor leads are either color-coded or numbered for identification. There are variations in the color codings between manufacturers, so it is always best to check the old motor first to make sure the existing wiring system is identified and diagrammed. If not, make your own diagram at the time of disassembly.

**Fact:** Most Fasco® PSC replacement motors have two brown capacitor leads in order to provide a simple hook-up. One of the brown leads has a white tracer on it. This lead can be cut off and insulated when only one capacitor lead is desired. It is common to see OEM applications with only one capacitor lead connected to the capacitor. The other lead on the other side of the capacitor is usually the common.

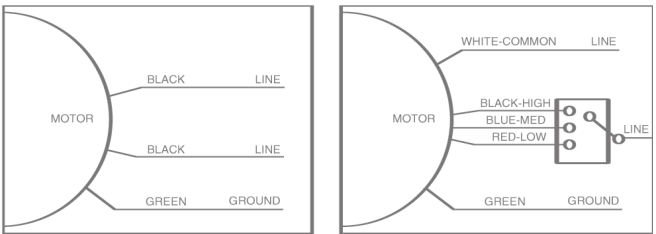

## Typical Wiring Diagram for Shaded-Pole Motors

*Standard wiring color codes as used by FASCO and most other manufacturers for Shaded-Pole motors.*

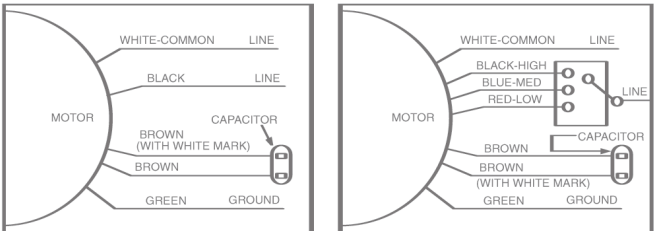

## Typical Wiring Diagram for PSC Motors

*Permanent-Split Capacitor motors have many different kinds of wiring arrangements. The standard for FASCO and most other manufacturers is shown.*

**Fact:** If the ground lead is present, it will be green or green with a yellow tracer. The wiring diagram for all Fasco® motors is shown on the motor nameplate.

**Fact:** To reverse rotation of Fasco electrically reversible models, switch the four external connectors (two female receptors and two male plugs). It's impossible to plug the male plugs together, and it's impossible to plug the female receptors into each other. One plug goes into each receptor and, if rotation is wrong, simply reverse the plugs.

**Fact:** The current Fasco reversing lead system consists of two yellow and two purple leads.

**Fact:** On multi-speed motors, always connect the common (white) lead to the power first.

**Fact:** Connecting like color leads (yellow to yellow, purple to purple) will give clockwise rotation (shaft end). Connecting unlike color leads will give counter-clockwise rotation (shaft end).

**Fact:** When the original motor does not have two separate capacitor leads and the original wiring pattern is desired, the following wiring diagram can be used on many Fasco motors.

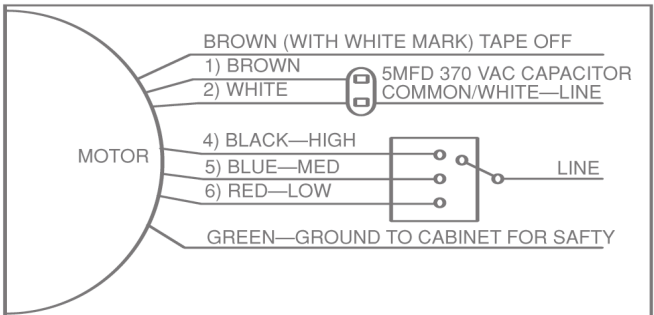

# MOTOR WIRING AND ROTATION REVERSING *(continued)*

**Fact:** Mechanically reversing rotation is possible with certain models. The model will need to have the inherent feature of the stator being positioned exactly in the center of the motor. Each motor will need to be looked at on an individual basis. If the motor has thru-bolts, you can use the following procedures for reversing:

1. Remove the thru-bolts.
2. Remove one end shield.
3. Remove stator, turn it around, then reinsert it. Leads should be pulled through the available end shield ventilating openings.
4. Replace end shield, thru-bolts, and retighten thru-bolts.
5. Check that shaft turns freely. If shaft is tight, tap motor lightly with non-metallic mallet. It may sometimes be necessary to loosen and retighten thru-bolts.

**Fact:** When connecting multi-speed motors, always connect the common (white) lead to the power supply first. The various speed leads go to the switching device. **IMPORTANT:** If line voltage is applied to two of the speed leads at once, the motor winding can quickly overheat and fail. The overload cannot protect the motor in this case.

**Fact:** The direction of rotation of a Shaded-Pole motor is determined by the location of the shading bands (coil) imbedded in the stator poles. Rotation is toward the shading band.

**Fact:** Before dismantling a motor, scratch an arrow on the case of the bad motor indicating direction of rotation.

**Fact:** Rotation of Fasco® motors is defined by looking at the shaft end of single shaft motors or opposite lead end on double shaft motors.

**Fact:** Leads can easily be damaged, do not carry motor by leads.

**Fact:** Fasco motors all have wiring diagrams on the nameplate. Each model is designed with the versatility to replace many motors using features such as electrical reversing, and extended studs.

**Fact:** Green or green with a yellow tracer is always the ground wire.

**Fact:** Never connect the line voltage to two speed leads.

**Fact:** One brown capacitor lead, on Fasco motors that have two brown capacitor leads, has a white tracer. Tape off this lead if only one capacitor lead is required. Simply connect the solid brown lead to one side of the capacitor. The other side of the capacitor is where the motor's white lead is connected along with one of the AC power leads.



# MOTOR INSTALLATION

See diagram in this section.

1. Make sure all power to the unit is disconnected
2. Make sure you understand the motor wiring diagram. If you hook the motor up incorrectly, you void its warranty. Determine the leads on the replacement motor which correspond to the original motor leads. Additional leads may be present. Individually insulate all extra leads at this time. Extra leads may be unused speed leads or if the brown lead with the white tracer was cut off to match the OEM wiring.
3. Mount new motor in unit using appropriate accessory kits as required (lug kits, band kits, adapter plates, etc.).
4. Make electrical connection. Following the wiring diagram, reconnect each lead. Each lead from the motor will connect to a different point. If two motor leads connect to the same point, it is probably wired wrong.
5. Ground motor. For your safety, make sure motor is grounded. The motor frame must be connected to electrical service ground in accordance with local and national electrical code. This is accomplished by using the green or green with yellow tracer ground lead on the replacement motor and connecting it from a motor tie bolt to the metal chassis of the unit. Ensure that the metal chassis is also grounded to the electrical service ground.
6. Secure loose-hanging wires and recheck all work.
7. Apply power to unit.
8. Set controls such that motor operates on all the speeds.
9. Motor current should be checked noting the amp draw.
  - A. Amps should be no greater than 10% over nameplate amps or the motor is probably overloaded.
  - B. If amps are less than 25% of the nameplate amps, motor is possibly overpowered for the unit and will possibly trip the overload after a long period of time. Remember, electricity must perform efficiently; if not, it will make heat.
10. If there are problems with the replacement motor, they will usually show up during the first two hours of operation.

# MOUNTING MOTORS

**Fact:** If the motor to be replaced is mounted in a resilient base, the distance between the mounting rings must match within 1/4". Rubber mounting rings are 2-1/4" or 2-1/2" in diameter. Turning the rings around on the motor hubs will change the distance between the mounting points on the rings by 1/4".

**Fact:** Fasco® double shaft room air conditioning replacement motors can be used with a ring mounting adapter kit, which consists of 2-1/4" diameter rubber mounting rings and steel ring enlargers for changing the ring diameter to 2-1/2". The brackets can be mounted on the motor thru-bolts. These brackets can be positioned along the extended thru-bolts to provide a wide variety of distances between mounting rings.

**Fact:** When using a 2-1/4" mounting ring with the double metal rings that expand the diameter to 2-1/2", high horsepower motors may twist in the cradle base. Either use the 2-1/2" diameter Henrite rings or mount the motor so that the extended tie rod is butted up against the edge of the base to prevent twisting.

**Fact:** The distance from the bottom of the base to the centerline of the shaft must be matched. This dimension is usually 3" or 3-1/2". Fasco offers different sizes of cradle bases to fit most of the cradle-mounted models.

**Fact:** The motor is mounted partially within the blower housing with a three-point lug mount in many direct drive blower applications. Direct OEM replacement motors would come with lugs already welded on the motor for direct interchangeability. For general replacement, Fasco lug kits are available with a variety of mounting hole bolt circle diameters. Use of these kits provides what is commonly called a "belly band" mounting.

**Fact:** A mounting method which has become very popular in recent years is the flexible mounting brackets which Fasco calls the "Fas Mount." Three specially designed steel mounting arms are welded to a sturdy belly band. The shape of the arms provides superior vibration and noise reduction.

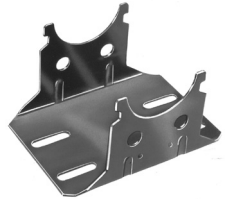





**Fact:** There are two common types of resilient rubber rings. Rings with a steel band are used with cradle bases and knife-edge supports. The other is all rubber rings which are used with direct drive blower motors and clamp-type supports.

**Fact:** The replacement motor must have a base mount which matches the shaft height when the replaced motor has a solid base affixed to the frame. This height is measured from the centerline of the shaft to the bottom of the base. The mounting hole spacing in the base must also match.

**Fact:** Motors are sometimes mounted on bulkheads using extended motor thru-bolts. There are many different ways motors are mounted, and Fasco offers many accessories to help meet these mounting needs. It is best to have the motor to be replaced with you when selecting a replacement motor. The key dimensions which should agree between the old and the new motors are:

1. Motor diameter.
2. Shaft length and diameter.
3. Distance between two rings if mounted on a resilient base.
4. Bolt circle diameter if lug-mounted.
5. Shaft height and base hole locations.

**Fact:** It is often possible to use larger or smaller diameter motors with the help of various available mounting accessories, particularly on lug-mounted or base-mounted motors.

**Fact:** When replacing motors in bathroom ventilators, kitchen ventilators, and range hoods, it is common for these motors to use a resilient six-sided hex-bearing hub. Fasco offers a kit that consists of two metal brackets and four nuts which will provide the 1-1/8" OD hex hub on 3-1/3" diameter motors.



**Fact:** When replacing condenser fan motors you will see some motors mounted off cables, shaft down, suspended from the center of the top of the grill. Fasco offers these cables as an accessory.



**Fact:** All Fasco distributor motors are designed for all-angle operation.

**Fact:** Motors installed horizontally should be rotated so that leads are in the 6 o'clock position or looped so water cannot enter the motor.

# CONTACTOR VA RATINGS

Contactors have something called sealed and inrush VAs. These VA ratings are requirements that the contactor has for the transformer supplying power to it. A contactor VA value is arrived at by multiplying the voltage and current requirements of the contactor coil. The user must make sure the control transformer can supply this amount of VA.

The VA and voltage rating is a standard method to rate transformers and is found on the transformer nameplate. Two types of VA ratings exist for contactors: inrush and sealed. Contactors act somewhat like motors with regards to the levels of current they draw.

The instant a contactor is energized, its current draw is at maximum. This is where the inrush VA requirement comes from. After a fraction of a second, the contactor will be physically closed and the VA requirement drops to a lower level. This lower level is the sealed VA requirement. The difference in the two values is substantial.

It is important for your customers to know if their transformer can supply the ratings needed by the contactors. If it cannot, the contactor may not close when it is energized. It could also result in an overheated control transformer.

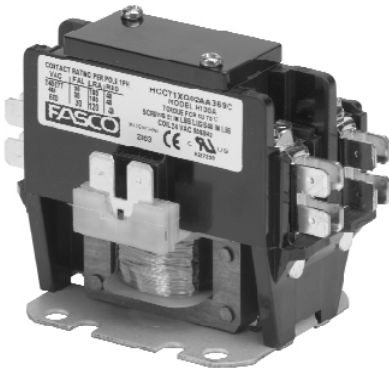

# INDUCED DRAFT BLOWERS

Many of the new energy-efficient gas furnaces use induced draft blowers to control flue gas. All induced draft blowers incorporate some type of signaling device to alert the furnace that the induced draft blower is operating. Some use a sail switch in the exhaust air stream. Others utilize a centrifugal switch or electronic sensor built into the motor, and some use a static pressure tap in the blower housing. All blowers are intended to provide air flow prior to ignition.

In today's furnace market, draft inducers are becoming a common replacement part. Since these furnaces are being designed with specific induced draft blowers, it is very important that replacements are installed using exact replacements. It is important that the replacements match the original blower for safety reasons.



These blowers play an important part in controlling the availability of gas to the burners. Most blowers will employ either a centrifugal switch, electronic sensor, or a vacuum tap to generate a signal to the gas valve that the induced draft blower is operating. This feature is necessary to prevent the gas valve from being turned on prematurely or in the event the blower does not operate properly.

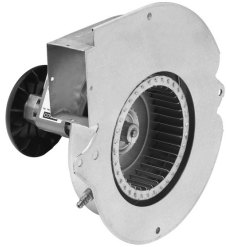

These blowers control the removal of the burnt by-products. Therefore, only replacement blowers made for specific furnaces or water heaters should be used for these replacements. The following paragraph describes why.

The blower is designed to produce a certain amount of airflow measured in CFM (cubic feet per minute). The airflow in some furnaces is needed to create a specific amount of vacuum at the vacuum tap mentioned above. If the replacement blower is not the exact one needed but "looks close," it may produce a lesser airflow and thereby a lesser vacuum at the vacuum tap. This may not allow the furnace to operate since the furnace will not think the induced draft blower is operating.

# BLOWER WHEELS AND FAN BLADES

In many applications, Fasco® PSC and Shaded-Pole motors are directly driving either a fan blade or a blower wheel. While both devices move air, a restriction to the air flow in a blower has an opposite effect on the same motor driving a fan blade. When a fan blade operates in the open (free air), the load on the motor is the least. As the air flow system or the filters become clogged, the load on the motor increases and the fan slows down. When the motor is driving a squirrel cage blower, the load on the motor decreases as the system becomes clogged and the blower speeds up.



**Fact:** In every replacement of a motor and blower, the rotation must be identified and matched. All Fasco replacement motors have a rotation arrow marked on their nameplates. If possible, scratch an arrow on the shell of the motor being replaced to indicate the direction of motor rotation. Do this before you remove the motor or blower.

**Fact:** Where it is impossible to determine motor rotation, the fan blade can be used. Hold the fan blade in a horizontal position, hub end up. If the blade curves down to the left, it is CW and if it curves down to the right, it is CCW when looking at the shaft end of the motor.

**Fact:** Blower rotation is often marked on the blower wheel itself. If not, the cups of the blower fins push the air, and that is the direction of rotation.

**Fact:** Dust build-up on a fan blade, blower wheel or rotor fin can help determine the motor rotation. The majority of dust will be on the leading edge of the fins or blades.

**Fact:** An increase in static pressure can be caused by a clogged furnace filter. This will make a blower unload and increase in speed but deliver less air. This generally results in less air over the motor for cooling. The motor will also draw less than nameplate amps.



**Fact:** It is desirable for a replacement propeller to have the same number of blades and pitch as the original propeller. Measure the pitch on the spider lobe, not on the wings themselves. The shape of the wing is also important. Do not interchange a pedestal fan blade that has rounded wings with a condenser fan blade that has squared wings unless you are sure it is a performance match. Two fan blades with different wing construction can vary widely in the horsepower requirements that are needed to spin them.

**Fact:** Air output in a furnace cannot be increased by just changing motor speed.

**Fact:** When replacing motors with fan blades mounted to them, it is a good time to inspect the blade. Check for bends, missing rivets, cracks in the blades or the hub assembly that may have appeared over its years of service. When replacing these blades, simply take note of the pitch of the wings, the diameter, original rotation, the bore, the hub, and the number of wings.

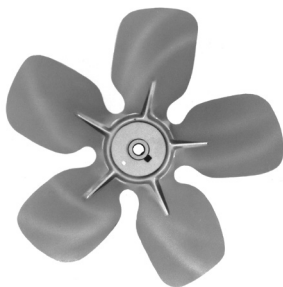

# FAN LAWS

There are many occasions when your customers will have an air-moving application such as a belt drive ventilator, and for one reason or another it becomes necessary to increase the amount of air flow being produced in the application. The following paragraphs that follow, describes some basic guidelines to offer your customer when it is time to select the new motor horsepower to do the job. Always suggest your customer review the change with the OEM first, before any changes are done.

Air flow is measured in cubic feet per minute (CFM). The pressure that develops when the moving air encounters restrictions such as a filter, is called static pressure (SP) and is measured in inches of water column. These two values along with required horsepower, change as the speed of the blower wheel or fan blade is changed. The relationships that describe the amount of change in CFM, SP and Horsepower when the speed changes are called Fan Laws.

Three of the laws are:

1.  $\text{New CFM/Old CFM} = \text{New speed/Old speed}$
2.  $\text{New SP/Old SP} = (\text{New speed/Old speed})^2$
3.  $\text{New HP/Old HP} = (\text{New speed/Old speed})^3$

For example, your customer needs to change the pulley sizes on a belt drive fan currently running at 450 RPM to increase air flow from 5000 CFM to 9000 CFM. Existing SP happens to be 0.5" and the motor horsepower is 1/2.

1. What new fan speed is needed?

Using the first Fan Law, and solving for New speed, you have the following:

$$\begin{aligned}\text{New speed} &= \text{Old speed}/(\text{New CFM/Old CFM}) \\ &= 450(9000/5000) \\ &= 810 \text{ RPM}\end{aligned}$$

2. What new static pressure will be generated?

Using the second Fan Law, and solving for New SP, you have the following:

$$\begin{aligned}\text{New SP} &= \text{Old SP} (\text{New speed/Old speed})^2 \\ &= 0.5(810/450)^2 \\ &= 1.62" \text{ water column}\end{aligned}$$



3. What new HP will be needed?

Using the third Fan Law, and solving for New HP, you have the following:

$$\begin{aligned}\text{New HP} &= \text{Old HP} (\text{New speed}/\text{Old speed})^3 \\ &= 0.5(810/450)^3 \\ &= 2.9 \text{ HP}\end{aligned}$$

**Your customer will need to use a 3 HP motor!**

This example shows that an 80% increase in air flow requires a 480% increase in HP. Careful consideration should be given to any changes in air-moving equipment to assure results are accurate and practical.

# GLOSSARY

**Air over** - Motors intended for fan and blower service. Motor must be located in the air stream to provide motor cooling.

**AC** - Abbreviation for alternating current. The current flow in the circuit alternates back and forth continuously. It does this 60 times per second with 60 Hz power.

**Amps** - The amount of electrical current flowing in an electrical circuit.

**Ambient Temperature** - The air temperature surrounding the motor.

**Blast Cooled** - A term used to describe a motor having an external fan and cooling case that forces cooling air over the motor. Similar to totally enclosed fan cooled.

**Bonderize** - A process in which zinc phosphate is applied to the motor shaft to help the shaft resist corrosion.

**BTU** - An abbreviation for British Thermal Unit. 12,000 BTUs equals 1 ton air conditioning.

**CSA** - An abbreviation for Canadian Standards Association. They set safety standards for motors and electrical equipment used in Canada. All Fasco 60 hertz motors meet CSA standards and display the CSA logo on the nameplate.

**CFM** - Abbreviation for Cubic Feet per Minute of air which the fan or blower is moving.

**Continuity** - A term used to describe a circuit that is complete. That is, the circuit is able to pass electric current.

**Cooling Degree Days** - Each degree that the average temperature is above 65° F produces one cooling degree day.

**CW/CCW** - Abbreviation for Clockwise/Counter-Clockwise rotation. CWSE means Clockwise rotation viewing the motor from the Shaft End. CWLE means Clockwise rotation when viewing the motor from the Lead End.

**Cycling (tripping)** - Motor overload is interrupting power to the motor due to excessive heat rise. It then turns the motor back on when the motor cools. Condition repeats continuously.

**DC** - An abbreviation for direct current. Current flows in one direction through the circuit.





**Efficiency** - The ratio or comparison of power output to power input.

**End Bell/End Shield** - The plates at each end of the motor which support the bearings.

**End Play** - This term refers to the in and out movement the rotor has in the motor. Excessive end play can result in problems such as fan blades hitting the fan guards. No end play can result in a tight motor.

**Fractional Horsepower** - Horsepower less than 1.

**Frame or Frame Size** - A designation that controls certain specifications that a motor will be built to if it is to be called a particular frame size. Specifications such as motor diameter are controlled.

**Free Air** - The blower or fan blade operates at free air when there are no effective restrictions to air flow at the outlet or inlet.

**Full Load Torque** - This is the amount of torque produced by a motor when it is running a full load speed at rated horsepower.

**Full Load Amps** - Amperage drawn by a motor when operating at rated load, voltage, and frequency.

**General Purpose Motor** - It is designed with standard operating characteristics and mechanical construction for use under usual service conditions. Has a service factor rating.

**Grounding** - The connection of a motor to an earth ground to reduce the possibility of electrical shock.

**Heating Degree Days** - Each degree that the average temperature is below 65°F produces one heating degree day.

**Hertz** - Frequency in cycles per second of an AC power supply. The U.S. operates on 60 hertz (H).

**Hi Pot (High Potential)** - This is a motor test used to detect conditions where electrical conductors (i.e., lead wires, magnet wire) may have come in contact with the non-electrical parts of the motor (i.e., stator laminations, shell).

# GLOSSARY

**Horsepower** - The rating of a motor's ability to do work.

HP = watts output / 746.

HP = (RPM x Torque in ounce-inches) / 1,000,000.

One HP = 746 watts.

**HVAC** - An abbreviation for heating, ventilation, and air conditioning.

**Inch-Ounce** - A measure of torque (twist). One inch-ounce is equal to one ounce of force applied 1" out away from center line of the shaft.

**Insulation Classes** - Insulation in a motor is rated by its temperature capability for providing reasonable motor life. The two most common are Class A - 105° C and Class B - 130° C. These are total temperatures, not temperature rises over ambient.

**Integral** - Whole number. Used to describe horsepowers of motors over one horsepower.

**Lead** - The hook-up wire brought out from the internal winding to make the external connections.

**Load Factor** - A rating used by Fasco to show the motor's actual horsepower compared with nameplate rating. For example, if a 1/4 HP motor has a load factor of 1.3, it is actually 30% stronger than the 1/4 HP rating.

**Lug** - Mounting bracket extending from the motor shell, usually three or four.

**Mechanical Duty** - Cooling by means of a fan inside or outside the motor housing.

**Microfarad (MFD)** - Capacitor rating

**Motor** - A machine that converts electrical energy into mechanical energy.

**Mounting** -

Rigid - Motor base welded solidly to the motor shell.

Resilient - Motor mounted in a bracket or a base using rubber rings on each end of the motor to isolate vibration.

Stud - Motor uses its extended thru-bolts (studs) to mount motor.



**National Electric Code (NEC)** - A national code written for the purpose of safeguarding persons and property from the hazards arising from the improper use of electricity. It is sponsored by the National Fire Protection Institute and used by insurance inspectors and by many government bodies regulating building codes.

**NEMA** - The National Electric Manufacturers Association. Construction and performance standards for motors, controls, and most electrical machines in the U.S. originate from this organization.

**OEM** - Abbreviation for Original Equipment Manufacturer.

**O.D. (Outside Diameter)** - The dimension of a round object measured across the outer edges at locations 180° apart.

**Ohms Law** - The basic relationship between the voltage, current, and resistance in a circuit.  $Voltage = Current \times Resistance$ .

**Overload Protector** - A temperature-detecting device built into the motor that disconnects the motor from the power source if the temperature rise becomes excessive.

**Permawick** - The oil-soaked cellulose fiber material that is packed into the motor end plates for sleeve-bearing lubrication. These fibers are made of 80-90% ground wood fibers and 10-20% sulfite fibers.

**Pitch** - Referring to the angle of the wings on a fan blade.

**PSC** - Permanent-Split Capacitor

**Resilient Mounting Ring** - This is a rubber ring that is part of the end plate assembly on some motors. Its primary function is to provide the customer a means of mounting the motor to a base or bracket on the equipment. This ring isolates vibration.

**Resistance** - This is the measure of a conductor's ability to conduct current. Resistance is measured in ohms. One ohm of resistance will allow one amp to flow through a conductor that has a voltage of one volt impressed on it.

# GLOSSARY

**Rotor** - The rotating member of a motor. It is constructed from stacked iron laminations. There are channels in the stack that are filled with molten aluminum. These aluminum bars get currents induced in them from the winding magnetic flux. The currents produce their own magnetic flux. This rotor flux interacts with the winding flux to produce rotation. The shaft is securely pressed on the rotor.

**RPM** - Shaft revolutions per minute.

**Service Factor** - Pertains to self-cooled motors. A measurement which states the percent horsepower the motor can carry beyond its nameplate rating and remain self-cooled. A service factor of 1.3 has a 30% horsepower margin built into the motor.

**Short** - This is a condition in the motor windings or conductors where the absence of insulation causes currents to by-pass their normal circuit path.

**Sleeve Bearing** - A sleeve style bushing used to support a rotor in a motor. This style provides quiet motor operation as compared to ball bearings.

**Slip** - A term describing the difference between the rotor speed and the speed of the motor's rotating magnetic field. Rotors always drag behind the speed of a magnetic field.

**Slot Insulation** - Also called Slot Liner. The insulation material used in the stator slots to protect the motor windings from scraping the laminations. It also provides winding protection against grounding to the laminations.

**Special Purpose Motor** - Designed for a specific application. Developed when an OEM has refined the operating characteristics or construction features of the motor. Does not have standard operating characteristics or standard mechanical features.

**Squirrel Cage Blower/Centrifugal Blower/Forward Curve Blower** - Air-moving devices consisting of a wheel made of many fins. The wheel is contained within a housing.

**Stack** - Thickness of a motor stator.

**Starting Torque** - The amount of turning force produced by a motor as it begins to turn from a standstill. Also called locked rotor torque.



**Static Balancing** - Balancing without rotation.

**Static Pressure** - The amount of resistance a system introduces to an air mover like a blower or fan blade. A blower seldom operates at free air. It generally is installed in a system that naturally creates resistance to air flow. The measured resistance is called static pressure. Fans and blowers are designed to deliver different amounts of air at different static pressure points.

**Stator** - The stack of iron laminations on which the coils are wound.

**Strobe** - An RPM measuring device that flashes light pulses at a rotating shaft. The pulses are adjusted until an optical illusion of the shaft standing still is obtained. At this point, the RPM reading is taken.

**Submersible Motor** - A motor whose housing is designed so that the motor can run under water; completely submerged. These are commonly used in water pumps.

**Synchronous Motor** - A motor that runs at synchronous speed without slip.

**Tachometer** - RPM measuring device.

**Temperature Rise** - Amount of heat a motor generates above the ambient temperature.

**Torque** - The twisting or turning force produced by the motor shaft.

**Voltage** - The measure of electromotive force that causes current to flow in a circuit.

**UL (Underwriter's Laboratories)** - An agency that establishes safety standards for manufacturers to follow.

**Watts Output** - The measure of mechanical power available from a motor. 746 watts equals one horsepower.





# HELP YOUR DISTRIBUTOR HELP YOU!

Provide the following information for more accurate motor replacement:

1. Before dismantling, scratch an arrow on the case of the motor indicating direction of rotation.
2. Note the voltage. Often, it is not indicated on the nameplate.
3. Note the number of speeds.
4. Note the type of motor: Permanent-Split Capacitor (PSC) or Shaded-Pole.
5. Note the shaft diameter.
6. Note the capacitor size if a PSC Motor.
7. Provide all nameplate data:
  - A. Horsepower
  - B. Amps
  - C. RPM
  - D. Frame size
  - E. Wiring connection
8. Provide any special application considerations. Often, the name of the OEM unit is important.

## **The Replacement Motor and Blower Specialist.**



**Regal Beloit America, Inc.**

1325 Heil Quaker Blvd.

LaVergne, TN 37086

866-293-0863

Fax 1-800-468-2062

[www.fasco.com](http://www.fasco.com)

**APPLICATION CONSIDERATIONS**

The proper selection and application of products and components, including paying full attention to the subject of product safety in the application, is the responsibility of the customer. Operating and performance requirements and potential associated issues will vary appreciably depending upon the use and application of such products and components. The scope of the technical and application information included in this publication is necessarily limited. Unusual operating environments and conditions, maintenance requirements, installation configurations, and other factors can materially affect the application and operating results of the products and components and the customer should carefully review its requirements. Any technical advice or reviews furnished by Regal Beloit America, Inc. or its affiliates ("Regal") with respect to the use of products and components is given in good faith and without charge. However, Regal assumes no obligation or liability for the advice given, or results obtained, all such advice and reviews being given and accepted are at the customer's risk.

For a copy of our Standard Terms and Conditions of Sale, Limited Warranty, and Limitations of Liability and Remedy, please contact Customer Service at 1-800-672-6495 or the website address: <http://www.regalbeloit.com> (link to "Terms and Conditions of Sale" at the bottom of the page). These terms and conditions of sale, disclaimers and limitations of liability apply to any person who may buy, acquire or use a Regal Beloit America Inc. product referred to herein, including any person who buys from a licensed distributor of these branded products.

Regal, Fasco, and Motor Mastery University are trademarks of Regal Beloit Corporation or one of its affiliated companies.

©2017, 2018 Regal Beloit Corporation, All Rights Reserved. MCB18084E • Form# F0007E

