

## CSW Series - 22mm



The WEG 22mm Pushbuttons and Pilot Device line uses leading edge technology and development. These user friendly pilot devices are used in many different industrial applications and environments.

### Standard Features:

- Fast and Easy Assembly of Pushbuttons and Contact Blocks
- High efficiency self-cleaning contact blocks
- Long life Expectancy
- High Luminosity and color with the LED Lights
- Full line of accessories



UL File No. E330817

### High Performance Illuminated Blocks

The CSW line features the BIDL (integrated LED illuminated blocks) which offer high efficiency - lumens/Watt - with low thermal dissipation and energy consumption. The integrated construction guarantees high resistance against vibrations and maintenance-free operation.



General Information

Circuit Protection

Disconnect Switches

Motor Protectors

Contactors

Overloads

Enclosed Starters

Relays

Pushbuttons and Pilot Lights

Terminal Blocks

Power Factor Correction

Appendix A

Appendix B



### Flush <sup>1</sup>

	Color	Catalog Number	List Price	Multiplier
 0.021 kg	○ White	CSW-BF0 WH	\$5	Z5
	● Red	CSW-BF1 WH	\$5	
	● Green	CSW-BF2 WH	\$5	
	● Yellow	CSW-BF3 WH	\$5	
	● Blue	CSW-BF4 WH	\$5	
	● Black	CSW-BF5 WH	\$5	

### Guarded

Image	Color	Catalog Number	List Price	Multiplier
 0.022 kg	○ White	CSW-BGA0 WH	\$5.50	Z5
	● Red	CSW-BGA1 WH	\$5.50	
	● Green	CSW-BGA2 WH	\$5.50	
	● Yellow	CSW-BGA3 WH	\$5.50	
	● Blue	CSW-BGA4 WH	\$5.50	
	● Black	CSW-BGA5 WH	\$5.50	

### Extended <sup>1</sup>

Image	Color	Catalog Number	List Price	Multiplier
 0.021 kg	○ White	CSW-BS0 WH	\$6.50	Z5
	● Red	CSW-BS1 WH	\$6.50	
	● Green	CSW-BS2 WH	\$6.50	
	● Yellow	CSW-BS3 WH	\$6.50	
	● Blue	CSW-BS4 WH	\$6.50	
	● Black	CSW-BS5 WH	\$6.50	

### Mushroom - External Diameter: 40 mm <sup>1</sup>

Image	Color	Catalog Number	List Price	Multiplier
 0.024 kg	● Red	CSW-BC1 WH	\$8.50	Z5
	● Green	CSW-BC2 WH	\$8.50	

#### How to order<sup>2)</sup>

Head  
 + Flange  
 + Contact block

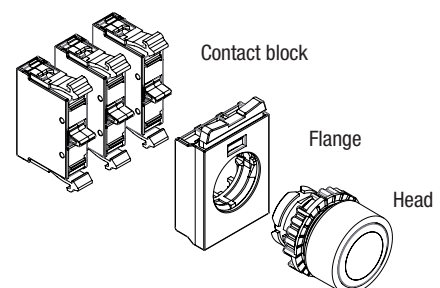







Notes: 1) Does not allow the use of contact blocks in the central position of the mounting flanges;  
 2) Check the maximum of recommended contact blocks for each head on pages 302.

# Pushbuttons and Pilot Lights





Pushbuttons with Latch - Ø22 mm - IP66

## Emergency Pushbuttons with Latch (EN 418 and IEC 60947-5-5)

### Emergency Pushbuttons with Latch - External Diameter: 42 mm<sup>2)</sup>

Image	Actuations	Signaling	Color	Catalog Number	List Price	Multiplier
 0.049 kg	Pull to release	-	 Red	<b>CSW-BESP WH</b>	<b>\$15</b>	Z5
 0.049 kg	Twist to release	-	 Red	<b>CSW-BESG WH</b>	<b>\$15</b>	
 0.114 kg	Key to release <sup>1)</sup>	-	 Red	<b>CSW-BESY WH</b>	<b>\$45</b>	
	GBES-02; Use with: CSW-BESP WH, CSW-BESG WH, CSW-BESY WH					

### Emergency Pushbuttons with Latch - External Diameter: 40 mm<sup>2)</sup>

Image	Actuations	Color	Catalog Number	List Price	Multiplier
 0.027 kg	Twist to release	 Red	<b>CSW-BEG WH</b>	<b>\$13</b>	Z5
 0.091 kg	With key <sup>1)</sup>	 Red	<b>CSW-BEY WH</b>	<b>\$40</b>	
	APEG-02; Use with: CSW-BCT1 WH, CSW-BCY1 WH				

#### How to order<sup>3)</sup>

Head  
+ Flange  
+ Contact block

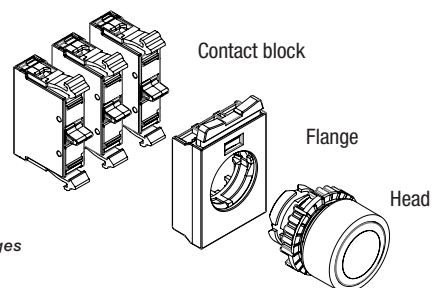

**Notes:**

- 1) Keys with different codes are available upon request.
- 2) Does not allow the use of contact blocks in the central position of the mounting flanges
- 3) Check the maximum of recommended contact blocks for each head on page 302.

## Illuminated Pushbuttons - Ø22 mm - IP66

### Flush<sup>1)</sup>

Image	Color	Catalog Number	List Price	Multiplier
 0.021 kg	White	CSW-BF10 WH	\$8.50	Z5
	Red	CSW-BF11 WH	\$8.50	
	Green	CSW-BF12 WH	\$8.50	
	Yellow	CSW-BF13 WH	\$8.50	
	Blue	CSW-BF14 WH	\$8.50	
	Orange	CSW-BF14 WH <sup>3</sup>	\$8.50	

### Extended<sup>1)</sup>

Image	Color	Catalog Number	List Price	Multiplier
 0.021 kg	White	CSW-BS10 WH	\$8.50	Z5
	Red	CSW-BS11 WH	\$8.50	
	Green	CSW-BS12 WH	\$8.50	
	Yellow	CSW-BS13 WH	\$8.50	
	Blue	CSW-BS14 WH	\$8.50	
	Orange	CSW-BS16 WH <sup>3</sup>	\$8.50	

### Mushroom - External Diameter: Ø40 mm<sup>1)</sup>

Image	Color	Catalog Number	List Price	Multiplier
 0.026 kg	White	CSW-BC10 WH	\$10	Z5
	Red	CSW-BC11 WH	\$10	
	Green	CSW-BC12 WH	\$10	
	Yellow	CSW-BC13 WH	\$10	
	Blue	CSW-BC14 WH	\$10	
	Orange	CSW-BC16 WH <sup>3</sup>	\$10	

### How to order<sup>2)</sup>

- Head
- + Flange
- + Contact block
- + Illumination block

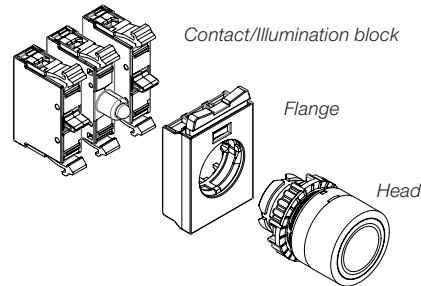

### Pilot Lights<sup>1)</sup>

Image	Color	Catalog Number	List Price	Multiplier
 0.016 kg	White	CSW-SD0 WH	\$7.30	Z5
	Red	CSW-SD1 WH	\$7.30	
	Green	CSW-SD2 WH	\$7.30	
	Yellow	CSW-SD3 WH	\$7.30	
	Blue	CSW-SD4 WH	\$7.30	
	Orange	CSW-SD6 WH <sup>3</sup>	\$7.30	

### How to order

- Head
- + Flange
- + Illumination block

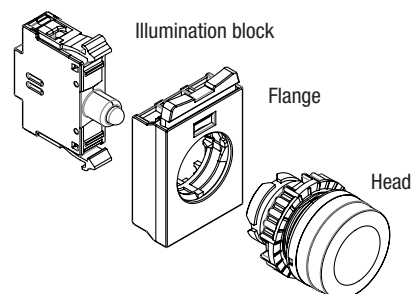

Notes: 1) Allows illumination through LED or lamp block  
 2) Check the maximum of recommended contact blocks for each head  
 3) For better lighting performance use yellow LED block with this device

# Pushbuttons and Pilot Lights

## 2 Positions Selectors - Ø22 mm - IP66

### Knob

 0.025 kg	Position		Diagram	Selector angle	Color <sup>1)</sup>		Part Number	List Price	Multiplier
		Fixed	1	45°	●	Black	<a href="#">CSW-CK2F45 WH</a>	\$13	
		With return	1	45°	●	Black	<a href="#">CSW-CK2R45 WH</a>	\$15	
		Fixed	1	90°	●	Black	<a href="#">CSW-CK2F90 WH</a>	\$13	
		With return	1	90°	●	Black	<a href="#">CSW-CK2R90 WH</a>	\$15	

### Lever

 0.025 kg	Position		Diagram	Selector angle	Color <sup>1)</sup>		Part Number	List Price	Multiplier
		Fixed	1	45°	●	Black	<a href="#">CSW-CA2F45 WH</a>	\$14	
		With return	1	45°	●	Black	<a href="#">CSW-CA2R45 WH</a>	\$16	
		Fixed	1	90°	●	Black	<a href="#">CSW-CA2F90 WH</a>	\$14	
		With return	1	90°	●	Black	<a href="#">CSW-CA2R90 WH</a>	\$16	

### With Key<sup>2)3)</sup>

 0.087 kg	Position		Diagram	Selector angle	Color <sup>1)</sup>		Part Number	List Price	Multiplier
		Fixed	1	45°	●	Black	<a href="#">CSW-CY2F45 WH</a>	\$41	
		With return	1	45°	●	Black	<a href="#">CSW-CY2R45 WH</a>	\$43	
		Fixed	1	90°	●	Black	<a href="#">CSW-CY2F90 WH</a>	\$41	
		With return	1	90°	●	Black	<a href="#">CSW-CY2R90 WH</a>	\$43	

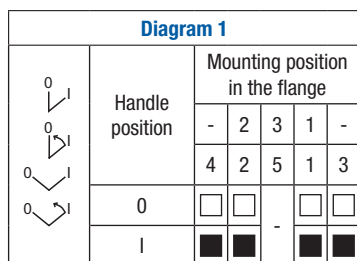

#### Legend

- Contacts in the rest position.
- Contacts operated.

### How to order<sup>4)</sup>

Head  
+ Flange  
+ Contact block

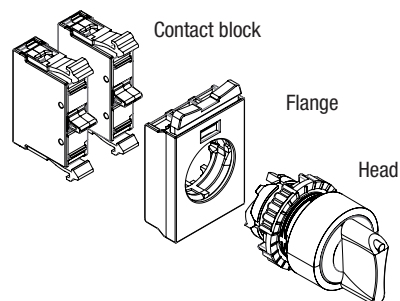

- Notes: 1) Selector switches in other colors are available under request;  
 2) Keys with different codes are available under request;  
 3) Key is released in any position. For key release in specific positions, please replace CY by: CYD (only at right), CYE (only at left) and CYC (only at center);  
 4) Check the maximum of recommended contact blocks for each head on page 302.

### Knob

0.025 kg	Position		Diagram	Selector angle	Color <sup>1)</sup>		Catalog Number	List Price	Multiplier
		Fixed	1	45°	●	Black	CSW-CK3F45 WH	\$13	
	With return	1	45°	●	Black	CSW-CK3R45 WH	\$15		
	With return from the right	1	45°	●	Black	CSW-CK3RD45 WH	\$15		
	With return from the left	1	45°	●	Black	CSW-CK3RE45 WH	\$15		

### Lever

0.025 kg	Position		Diagram	Selector angle	Color <sup>1)</sup>		Catalog Number	List Price	Multiplier
		Fixed	1	45°	●	Black	CSW-CA3F45 WH	\$14	
	With return	1	45°	●	Black	CSW-CA3R45 WH	\$16		
	With return from the right	1	45°	●	Black	CSW-CA3RD45 WH	\$16		
	With return from the left	1	45°	●	Black	CSW-CA3RE45 WH	\$16		

Diagram 1

Handle position	Mounting position in the flange					
	-	2	3	1	-	
I	■	■		□	□	
0	□	□		□	□	
II	□	□		■	■	

Legend

- Contacts in the rest position.
- Contacts operated.

### How to order

#### Head

- + Flange
- + Contact block

Notes: 1) Selector switches in other colors are available under request  
 2) Check the maximum of recommended contact blocks for each head on page 302.

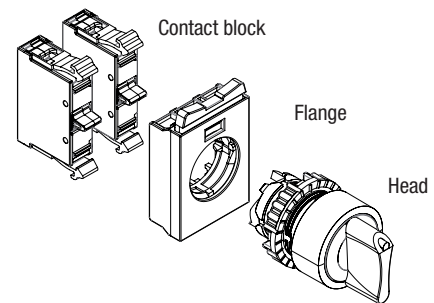

General Information

Circuit Protection

Disconnect Switches

Motor Protectors

Contactors

Overloads

Enclosed Starters

Relays

Pushbuttons and Pilot Lights

Terminal Blocks

Power Factor Correction

Appendix A

Appendix B

# Pushbuttons and Pilot Lights

A3 Positions Selectors - Ø22 mm - IP66 CW

With Key<sup>2)3)</sup>





Image	Position	Diagram	Selector angle	Color <sup>1)</sup>		Catalog Number	List Price	Multiplier
	 <p>0.087 kg</p>	 Fixed	1	45°	●	Black	<b>CSW-CY3F45 WH</b>	
 With return		1	45°	●	Black	<b>CSW-CY3R45 WH</b>	<b>\$43</b>	
 With return from the right		1	45°	●	Black	<b>CSW-CY3RD45 WH</b>	<b>\$43</b>	
 With return from the left		1	45°	●	Black	<b>CSW-CY3RE45 WH</b>	<b>\$43</b>	

Diagram 1

Handle position	Mounting position in the flange					
	-	2	3	1	-	
I	■	■		□	□	
0	□	□	-	□	□	
II	□	□		■	■	

Legend

- Contacts in the rest position.
- Contacts operated.

How to order<sup>4)</sup>

Head  
+ Flange  
+ Contact block

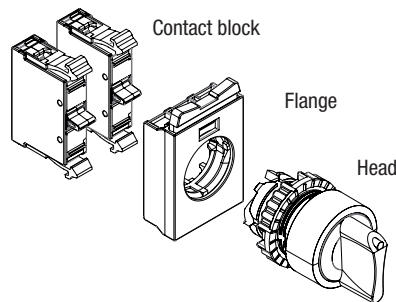



- Notes: 1) Selector switches in other colors are available under request;  
 2) Keys with different codes are available under request;  
 3) Key is released in any position. For key release in specific positions, please replace CY by: CYD (only at right), CYE (only at left) and CYC (only at center);  
 4) Check the maximum of recommended contact blocks for each head on page 302.

Reset Pushbutton with Shaft

Image	Description	Catalog Number	Weight (kg)	List Price	Multiplier
	Flush pushbutton - blue - engraved reset - with shaft. Length: max. 250 mm and min. 22.5 mm	<b>CSW-BHF437</b>	0.045	<b>\$12</b>	Z5

### 2 Positions Illuminated Selectors

Image	Position	Diagram	Selector angle	Color	Catalog Number	List Price	Multiplier
 0.020 kg	 Fixed	1	90°	○ White	CSW-CKI2F900 WH	\$8	Z5
				● Red	CSW-CKI2F901 WH	\$8	
				● Green	CSW-CKI2F902 WH	\$8	
				● Yellow	CSW-CKI2F903 WH	\$8	
				● Blue	CSW-CKI2F904 WH	\$8	
				● Orange	CSW-CKI2F906 WH <sup>1</sup>	\$8	

### 3 Positions Illuminated Selectors





Image	Position	Diagram	Selector angle	Color	Catalog Number	List Price	Multiplier
 0.020 kg	 Fixed	2	45°	○ White	CSW-CKI3F450 WH	\$8	Z5
				● Red	CSW-CKI3F451 WH	\$8	
				● Green	CSW-CKI3F452 WH	\$8	
				● Yellow	CSW-CKI3F453 WH	\$8	
				● Blue	CSW-CKI3F454 WH	\$8	
				● Orange	CSW-CKI3F456 WH <sup>1</sup>	\$8	
	 With return	2	45°	○ White	CSW-CKI3R450 WH	\$8.50	
				● Red	CSW-CKI3R451 WH	\$8.50	
				● Green	CSW-CKI3R452 WH	\$8.50	
				● Yellow	CSW-CKI3R453 WH	\$8.50	
				● Blue	CSW-CKI3R454 WH	\$8.50	
				● Orange	CSW-CKI3R456 WH <sup>1</sup>	\$8.50	
	 With return from the right	2	45°	○ White	CSW-CKI3RD450 WH	\$8.50	
				● Red	CSW-CKI3RD451 WH	\$8.50	
				● Green	CSW-CKI3RD452 WH	\$8.50	
				● Yellow	CSW-CKI3RD453 WH	\$8.50	
				● Blue	CSW-CKI3RD454 WH	\$8.50	
				● Orange	CSW-CKI3RD456 WH <sup>1</sup>	\$8.50	
	 With return from the left	2	45°	○ White	CSW-CKI3RE450 WH	\$8.50	
				● Red	CSW-CKI3RE451 WH	\$8.50	
				● Green	CSW-CKI3RE452 WH	\$8.50	
				● Yellow	CSW-CKI3RE453 WH	\$8.50	
				● Blue	CSW-CKI3RE454 WH	\$8.50	
				● Orange	CSW-CKI3RE454 WH <sup>1</sup>	\$8.50	

Diagram 1					Diagram 2					Flange		
Handle position	Mounting position in the flange					Handle position	Mounting position in the flange					
		-	2	3	1		-		-	2	3	1
4		2	5	1	3	4	2		5	1	3	5P
0	□	□	☼	□	□	I	■	■	□	□		
I	■	■	☼	■	■	0	□	□	☼	□	□	
						II	□	□	■	■		

**Legend**  
 □ Contacts in the rest position.  
 ■ Contacts operated.  
 ☼ Mounting position for LED blocks in illuminated switches.

POTENTIOMETER

CSW-POT\_W

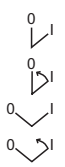
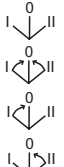
LIST PRICE \$145



Resistance

CSW-POT \_ W

1	-	1kΩ	10	-	10kΩ
2	-	2kΩ	50	-	50kΩ
5	-	5kΩ			





Note:

1) For better lighting performance use yellow LED Block





# Pushbuttons and Pilot Lights



## Flush Double Pushbutton - Degree of Protection IP40<sup>1)2)4)</sup> - (refer to 1. How to order)

 0.034 kg	Color		Engraving	Reference	List Price	Multiplier
		Green	I	CSW-BD WH	11.50	Z5
		Red	0			
		Green	START	CSW-BD21SS WH	11.50	
		Red	STOP			



## Double Pushbutton - (refer to 1. How to order)

 0.034 kg	Frontal	Color		Engraving	Reference	List Price	Multiplier
	Flush		Green	I	CSW2-BDF2110 WH	14.00	Z5
	Flush		Red	0			
	Flush		Green	START	CSW2-BDF21SS WH	14.00	
	Flush		Red	STOP			



## Extended Double Pushbutton - (refer to 1. How to order)

 0.034 kg	Frontal	Color		Engraving	Reference	List Price	Multiplier
	Flush		Green	I	CSW2-BDS2110 WH	14.00	Z5
	Extended		Red	0			
	Flush		Green	START	CSW2-BDS21SS WH	14.00	
	Extended		Red	STOP			



## Triple Pushbutton - (refer to 1. How to order)

 0.034 kg	Frontal	Color		Engraving	Reference	List Price	Multiplier
	Flush		Green	I	CSW2-BTF24110R WH	16.00	Z5
	Extended		Blue	RESET			
	Flush		Red	0			



## Extended Triple Pushbutton - (refer to 1. How to order)

 0.034 kg	Frontal	Color		Engraving	Reference	List Price	Multiplier
	Flush		Green	I	CSW2-BTS24110R WH	16.00	Z5
	Extended		Blue	RESET			
	Extended		Red	0			

## Flush Double Pushbutton w/ illumination - (refer to 2. How to order)<sup>1</sup>

 0.025g	Frontal	Color		Engraving	Reference	List Price	Multiplier
	Flush		Green	I	CSW2-BDFI2110 WH	14.00	Z5
	Flush		Red	0			
	Flush		Green	START	CSW2-BDFI21SS WH	14.00	
Flush	Red		STOP				

## Extended Double Pushbutton w/ illumination - (refer to 2. How to order)<sup>1</sup>

 0.025g	Frontal	Color		Engraving	Reference	List Price	Multiplier
	Flush		Green	I	CSW2-BDSI2110 WH	14.00	Z5
	Extended		Red	0			
	Flush		Green	START	CSW2-BDSI21SS WH	14.00	
Extended	Red		STOP				

### 1. How to order<sup>3)4)</sup>

Head  
+ Flange  
+ Contact block

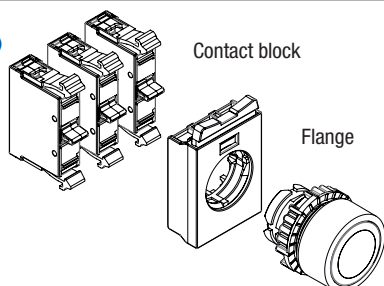

### 2. How to order<sup>3)4)</sup>

· Head  
+ Flange  
+ Contact block  
+ Illumination block

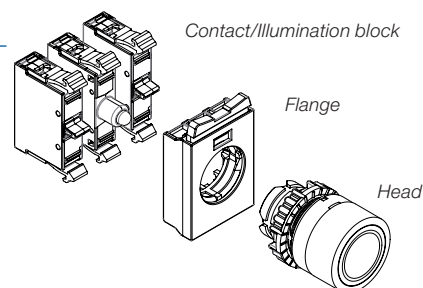



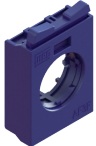

- Notes:
- 1) Does not allow the use of contact blocks in the central position of the mounting flanges
  - 2) To increase the Degree of Protection, use the APBD silicon protective cover
  - 3) Check the maximum of recommended contact blocks for each head on page 302.
  - 4) Use blue flange and contact block components

### Flanges<sup>1</sup>

	Description	Standard packing	Catalog Number	List Price	Multiplier
 0.010 kg <sup>2)</sup>	3-position mounting flange for blue contact blocks Allows the mounting of extras contact blocks due to front-back system	1 piece	AF3F	\$2.17	Z5
	5-position mounting flange for blue contact blocks Allows the mounting of extras contact blocks due to front-back system	1 piece	AF5F	\$6.06	

### Contact Blocks<sup>1)</sup>

	Contacts	Diagram	Standard packing	Compatible flange	Catalog Number	List Price	Multiplier
 0.015 kg <sup>2)</sup>	1NO		1 piece	AF3F	BC10F-CSW	\$5.00	Z5
	1NC		1 piece		BC01F-CSW	\$5.00	
	1NO EARLY MAKE		1 piece	AF3F	BCA10F-CSW	\$5.55	
	1NC LATE BREAK		1 piece		BCR01F-CSW		

### Self-Monitoring Contact Block for Emergency Pushbuttons<sup>1)2)</sup>

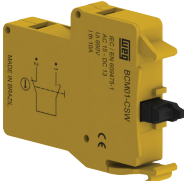
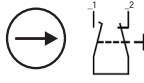
	Contacts	Diagram	Standard packing	Compatible flange	Catalog Number	List Price	Multiplier
 0.002 kg <sup>2)</sup>	1NC		1 piece	AF3F	BCM01F-CSW	\$27.37	Z5

**Notes:**

- 1) Not compatible with the PBW control stations line. For control stations accessories, please refer to the page 295 and 296. of this catalog  
 2) The NO contact close when assembled correctly in the flange

- General Information
- Circuit Protection
- Disconnect Switches
- Motor Protectors
- Contactors
- Overloads
- Enclosed Starters
- Relays
- Pushbuttons and Pilot Lights
- Terminal Blocks
- Power Factor Correction
- Appendix A
- Appendix B

# Pushbuttons and Pilot Lights

## Accessories for CSW (22mm)

### Illumination Blocks with Integrated LED<sup>1)2)3)</sup>

	Image	Voltage	Color	Diagram	Standard packing	Compatible flange	Catalog Number	List Price	Multiplier
General Information		12 V ac/dc	○ White		1 piece	AF3F	CSW-BIDL0E25	\$16	Z5
			● Red				CSW-BIDL1E25	\$16	
			● Green				CSW-BIDL2E25	\$16	
			● Yellow				CSW-BIDL3E25	\$16	
			● Blue				CSW-BIDL4E25	\$16	
			○ White				CSW-BIDL0E26	\$16	
Circuit Protection		24 V ac/dc	● Red	CSW-BIDL1E26	\$16				
			● Green	CSW-BIDL2E26	\$16				
			● Yellow	CSW-BIDL3E26	\$16				
			● Blue	CSW-BIDL4E26	\$16				
			○ White	CSW-BIDL0E27	\$16				
			● Red	CSW-BIDL1E27	\$16				
Disconnect Switches		48 V ac/dc	● Green	CSW-BIDL2E27	\$16				
			● Yellow	CSW-BIDL3E27	\$16				
			● Blue	CSW-BIDL4E27	\$16				
			○ White	CSW-BIDL0E10	\$16				
			● Red	CSW-BIDL1E10	\$16				
			● Green	CSW-BIDL2E10	\$16				
Motor Protectors		110-130 V ac	● Yellow	CSW-BIDL3E10	\$16				
			● Blue	CSW-BIDL4E10	\$16				
			○ White	CSW-BIDL0D66	\$16				
			● Red	CSW-BIDL1D66	\$16				
			● Green	CSW-BIDL2D66	\$16				
			● Yellow	CSW-BIDL3D66	\$16				
Contactors		220-240 V ac	● Blue	CSW-BIDL4D66	\$16				
			○ White	CSW-BIDL0E10	\$16				
			● Red	CSW-BIDL1E10	\$16				
			● Green	CSW-BIDL2E10	\$16				
			● Yellow	CSW-BIDL3E10	\$16				
			● Blue	CSW-BIDL4E10	\$16				
Overloads		125 V dc	○ White	CSW-BIDL0E10	\$16				
			● Red	CSW-BIDL1E10	\$16				
			● Green	CSW-BIDL2E10	\$16				
			● Yellow	CSW-BIDL3E10	\$16				
			● Blue	CSW-BIDL4E10	\$16				
			○ White	CSW-BIDL0E10	\$16				
Enclosed Starters		125 V dc	● Red	CSW-BIDL1E10	\$16				
			● Green	CSW-BIDL2E10	\$16				
			● Yellow	CSW-BIDL3E10	\$16				
			● Blue	CSW-BIDL4E10	\$16				
			○ White	CSW-BIDL0E10	\$16				
			● Red	CSW-BIDL1E10	\$16				
Relays		125 V dc	● Green	CSW-BIDL2E10	\$16				
			● Yellow	CSW-BIDL3E10	\$16				
			● Blue	CSW-BIDL4E10	\$16				
			○ White	CSW-BIDL0E10	\$16				
			● Red	CSW-BIDL1E10	\$16				
			● Green	CSW-BIDL2E10	\$16				

0.016 kg

### Voltage Reduction Blocks<sup>1)2)3)</sup>

	Image	Description	U <sub>e</sub>	Diagram	Standard packing	Compatible flange	Catalog Number	List Price	Multiplier
Pushbuttons and Pilot Lights		For use with Integrated LED blocks models: CSW-BIDL(F)_D66 (220-240 V ac)	380-460 V ac		1 piece	AF3 AF5	CSW-BRT4F	\$8.88	Z5

**Notes:**

- 1) Not compatible with the PBW control stations line. For control stations accessories, please refer to the page 295 and 296. of this catalog
- 2) Unitary weight.
- 3) Not compatible with black flanges

### Ba9s Socket Lamp Block<sup>1)2)4)</sup>

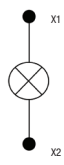
 0.013 kg	Description	Diagram	Standard packing	Compatible flange	Catalog Number	List Price	Multiplier
	<ul style="list-style-type: none"> <li>- For lamps with Ba9s socket</li> <li>- Maximum voltage 380 V (2 W)</li> <li>- Direct V ac/dc</li> <li>- Lamp not included</li> </ul>		1 piece	AF3 AF5	<b>CSW-BIDF</b>	<b>\$5.27</b>	Z5

### Lamps Ba9s<sup>1)2)</sup>

 0.005 kg <sup>3)</sup>	Voltage	Standard packing	Catalog Number	List Price	Multiplier
	6 V ac/dc	25 pieces	<b>CSW-LI E48-0.6W</b>	<b>\$242.50</b>	Z5
	12 V ac/dc	25 pieces	<b>CSW-LI E25-1.8W</b>	<b>\$242.50</b>	
	24 V ac/dc	25 pieces	<b>CSW-LI E26-2W</b>	<b>\$242.50</b>	
	48 V ac/dc	25 pieces	<b>CSW-LI E27-2W</b>	<b>\$242.50</b>	
	60 V ac/dc	25 pieces	<b>CSW-LI E29-1.2W</b>	<b>\$242.50</b>	
	130 V ac/dc	25 pieces	<b>CSW-LI E30-2W</b>	<b>\$242.50</b>	
	220 V ac/dc	25 pieces	<b>CSW-LI E31-2W</b>	<b>\$242.50</b>	

### Illumination Block with Lamp + Resistor + Diode<sup>1)2)4)</sup>

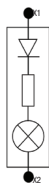
 0.016 kg	Description	Diagram	Standard packing	Compatible flange	Catalog Number	List Price	Multiplier
	<ul style="list-style-type: none"> <li>- Block voltage: 220 - 240 V ac</li> <li>Includes 120/130 V incandescent lamp</li> <li>- Ba9s socket</li> </ul>		1 piece	AF3F AF5F	<b>CSW-BIRDFD66</b>	<b>\$25.34</b>	Z5

### Ba9s Lamps Extraction Tool<sup>4)</sup>

 0.008 kg	Description	Standard packing	Catalog Number	List Price	Multiplier
	Ba9s lamps extraction tool of illumination blocks	1 piece	<b>ACEF</b>	<b>\$5.60</b>	Z5

### Push-on/Push-off Block<sup>1)2)4)</sup>



 0.019 kg	Description	Standard packing	Compatible flange	Catalog Number	List Price	Multiplier
	Push-on/Push-off block for: CSW-BF, CSW-BFI, CSW-BS, CSW-BSI, CSW-BGA, CSW-BC, CSW-BCI. Note: use only with the following contact blocks: <ul style="list-style-type: none"> <li>- BC01-F (1NC);</li> <li>- BCA10-F (1NO early-make);</li> <li>- BC02-F (2NC).</li> </ul>	1 piece	AF3	<b>BR-3PF-CSW</b>	<b>\$7.97</b>	Z5

Notes: 1) Not compatible with the PBW control stations line. For control stations accessories, please refer to the page 295 and 296  
 2) Not compatible with double pushbuttons CSW2-BD;  
 3) Unitary weight.  
 4) Not compatible with black flanges

# Pushbuttons and Pilot Lights

## Accessories for CSW (22mm)

### Plate Holder and Plastic Legend Plate Set<sup>1)</sup>

	Description	Standard packing	Catalog Number	List Price	Multiplier
 0.004 kg <sup>2)</sup>	Plate holder and plastic legend plate set (27 x 18 mm, no engraved, red and black colored) for pilot lights, single pushbuttons and selector switches.	5 pieces	<b>APP30</b>	<b>\$11.50</b>	25
	Plate holder and plastic legend plate set (27 x 18 mm, no engraved, red and black colored) for double pushbuttons CSW-BD. Not compatible with CSW2-BD.	1 piece	<b>APP60</b>	<b>\$2.30</b>	
 0.004 kg <sup>2)</sup>	Plate holder and plastic legend plate set (27 x 18 mm, no engraved, translucent) for pilot lights, single pushbuttons and selector switches.	5 pieces	<b>APP30T</b>	<b>\$11.50</b>	
	Plate holder and plastic legend plate set (27 x 18 mm, no engraved, translucent) for double pushbuttons CSW-BD. Not compatible with CSW2-BD.	1 piece	<b>APP60T</b>	<b>\$3</b>	

### Reduction Ring<sup>1)</sup>

	Description	Standard packing	Catalog Number	List Price	Multiplier
 0.030 kg	Reduction ring from Ø30 mm to Ø22 mm	5 pieces	<b>AR30</b>	<b>\$21.25</b>	25

Notes: 1) Not compatible with the PBW control stations line. For control stations accessories, please refer to the page 295 and 296 of this catalog  
 2) Unitary weight.

### Emergency-Stop Plate<sup>1)</sup>

	Description	Standard packing	Catalog Number	List Price	Multiplier
 0.009 kg <sup>2)</sup>	Legend plate for emergency pushbutton. Text: English	1 piece	<b>APE-02</b>	<b>\$8.30</b>	25

### APP30 Plate Holder and 27 x 18 mm Engraved Plastic Legend Plate Set<sup>1)3)</sup>

For use with single pushbuttons,  
pilot lights and selector  
switches



+

**MANUAL**

Standard packing  
5 pieces

0.015 kg<sup>4)</sup>

### Pushbuttons and Pilot Lights

Catalog Number	Message	List Price	Multiplier
APP30-01	CLOSE	\$4.20	Z5
APP30-02	DOWN	\$4.20	
APP30-03	EMERGENCY STOP	\$4.20	
APP30-04	FORWARD	\$4.20	
APP30-05	JOG	\$4.20	
APP30-06	JOG FORWARD	\$4.20	
APP30-07	JOG REVERSE	\$4.20	
APP30-08	LOWER	\$4.20	
APP30-09	OFF	\$4.20	
APP30-10	ON	\$4.20	
APP30-11	OPEN	\$4.20	
APP30-12	POWER ON	\$4.20	
APP30-13	RAISE	\$4.20	
APP30-14	RESET	\$4.20	
APP30-147	FAULT	\$4.20	
APP30-15	REVERSE	\$4.20	
APP30-16	RUN	\$4.20	
APP30-17	START	\$4.20	
APP30-18	STOP	\$4.20	
APP30-19	UP	\$4.20	
APP30-20	FORWARD REVERSE	\$4.20	
APP30-21	HAND AUTO	\$4.20	
APP30-22	JOG RUN	\$4.20	
APP30-23	MANUAL AUTO	\$4.20	
APP30-24	OFF ON	\$4.20	
APP30-25	OPEN CLOSE	\$4.20	
APP30-26	RUN JOG	\$4.20	
APP30-27	START STOP	\$4.20	
APP30-28	UP DOWN	\$4.20	
APP30-30	FOR OFF REV	\$4.20	
APP30-31	HAND OFF AUTO	\$4.20	
APP30-32	MAN OFF AUTO	\$4.20	
APP30-33	OPEN OFF AUTO	\$4.20	
APP30-34	OPEN OFF CLOSE	\$4.20	
APP30-35	UP OFF DOWN	\$4.20	
APP30-36	ON/OFF	\$4.20	
APP30-37	OPEN/CLOSE	\$4.20	
APP30-38	UP/DOWN	\$4.20	
APP30-P00	0-100	\$6.00	
APP30-P01	0-10	\$6	
APP30-P02	SPEED 0-10	\$6	
APP30-P03	SPEED 0-100	\$6	
APP30-149	AUTO OFF REV	\$4.20	
APP30-198	LOW MED HIGH	\$4.20	
APP30-199	LOW OFF HIGH	\$4.20	

Notes: 1) Other engraving option available upon request. APP60 legend plates are also available upon request.

2) Red plates are engraved in white

3) Not compatible with the PBW Control Stations Line. For control station accessories, please refer to the page 295 and 296.

4) Unitary weight

Data is subject to change without notice.

CSW Series (22mm)

## Decentralized Control Stations - PBW

### Type 4x Protection

WEG control stations and emergency stop stations, also known as the PBW line, are available for a wide range of applications meeting the most demanding requirements of quality, robustness and modular design. The PBW line has been developed meeting the requirements of international standards such as IEC 60947-5-1, IEC 50102, IEC 60529 and UL 508 and can be used with WEG current pushbuttons and signaling units (CSW series).

### Standard Features:

- IP66/Type 4x degree of protection: accurate design combined with a special sealing gasket assures the degree of protection throughout product life cycle
- Several cable entries: knock-out type entries on the top, base and side, meeting different cable glands with different threads
- Exclusive ID plate holding system: integrated to the construction, allows for standard CSW legend plates
- Captive screws: ensures safe and easy operations without losing hardware
- Premium polycarbonate construction: non-flammable and UV ray protected, its oversized thickness offers high mechanical resistance
- The PWB line is very cost effective, and inventory is always readily available.



IP66 degree of protection







Exclusive ID plate holding system

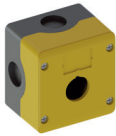

UL File No. E330817

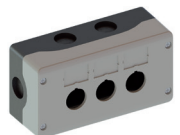
### Type 4X Decentralized Control Stations <sup>1)</sup>

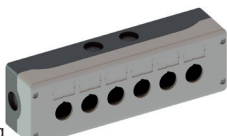

	Number of holes	Color		Standard packing	Catalog Number	Price	Multiplier
		Cover	Base				
 0.114 kg	1	Yellow	Black	1 piece	PBW-1Y	\$25	Z5
 0.114 kg					PBW-1	\$25	
 0.152 kg	2	Gray			PBW-2	\$30	
 0.185 kg	3				PBW-3	\$34	
 0.215 kg	4				PBW-4	\$41	
 0.276 kg	6				PBW-6	\$59	

### Emergency Pushbuttons with Decentralized Control Station

	PBW control station	Pushbuttons	Contact blocks	Plate	Catalog Number	Weight (kg)	List Price	Multiplier
	Yellow - 1 hole	Emergency stop CSW-BESG	1NO + 1NC	Red engraved "EMERGENCY STOP"	PBW1Y-G11 P03	0.212	\$48.00	Z5

### Accessories - Mounting in Control Stations

#### Contact Block<sup>2)</sup>

	Description	Contacts	Diagram	Standard packing	Catalog Number	Price	Multiplier
 0.015 kg <sup>3)</sup>	Single contact blocks to mounting in control stations or DIN rail 35 mm	1NO		1 piece	BC10B-CSW	\$5.00	Z5
		1NC		1 piece	BC01B-CSW	\$5.00	

Notes: 1) Compatible with all single of the CSW line pushbuttons, selector switches and pilot lights. To avoid interferences and ensure the performance when use a mushroom pushbutton beside another pushbutton, WEG recommend maintaining an empty hole between the pushbuttons. To close the hole use the ATR accessory;

2) Blocks specific for mounting in base or PBW plastic control stations or DIN rail 35mm;

3) Unitary weight.













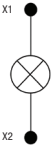





















# Pushbuttons and Pilot Lights

Accessories for CSW (22mm)

## Mounting in Control Stations



Illumination Blocks with Integrated LED<sup>1)</sup>

Image	Voltage	Color	Diagram	Standard packing	Catalog Number	Price	Multiplier
 <p>0.016 kg</p>	12 V ac/dc	 White		1 piece	<a href="#">CSW-BIDLB-0E25</a>	\$16.60	25
		 Red			<a href="#">CSW-BIDLB-1E25</a>	\$16.60	
		 Green			<a href="#">CSW-BIDLB-2E25</a>	\$16.60	
		 Yellow			<a href="#">CSW-BIDLB-3E25</a>	\$16.60	
		 Blue			<a href="#">CSW-BIDLB-4E25</a>	\$16.60	
	24 V ac/dc	 White			<a href="#">CSW-BIDLB-0E26</a>	\$16.60	
		 Red			<a href="#">CSW-BIDLB-1E26</a>	\$16.60	
		 Green			<a href="#">CSW-BIDLB-2E26</a>	\$16.60	
		 Yellow			<a href="#">CSW-BIDLB-3E26</a>	\$16.60	
		 Blue			<a href="#">CSW-BIDLB-4E26</a>	\$16.60	
	48 V ac/dc	 White			<a href="#">CSW-BIDLB-0E27</a>	\$16.60	
		 Red			<a href="#">CSW-BIDLB-1E27</a>	\$16.60	
		 Green			<a href="#">CSW-BIDLB-2E27</a>	\$16.60	
		 Yellow			<a href="#">CSW-BIDLB-3E27</a>	\$16.60	
		 Blue			<a href="#">CSW-BIDLB-4E27</a>	\$16.60	
	110-130 V ac	 White			<a href="#">CSW-BIDLB-0E10</a>	\$16.60	
		 Red			<a href="#">CSW-BIDLB-1E10</a>	\$16.60	
		 Green			<a href="#">CSW-BIDLB-2E10</a>	\$16.60	
		 Yellow			<a href="#">CSW-BIDLB-3E10</a>	\$16.60	
		 Blue			<a href="#">CSW-BIDLB-4E10</a>	\$16.60	
	220-240 V ac	 White			<a href="#">CSW-BIDLB-0D66</a>	\$16.60	
		 Red			<a href="#">CSW-BIDLB-1D66</a>	\$16.60	
		 Green			<a href="#">CSW-BIDLB-2D66</a>	\$16.60	
		 Yellow			<a href="#">CSW-BIDLB-3D66</a>	\$16.60	
 Blue		<a href="#">CSW-BIDLB-4D66</a>	\$16.60				
125 V dc	 White	<a href="#">CSW-BIDLB-0E10</a>	\$16.60				
	 Red	<a href="#">CSW-BIDLB-1E10</a>	\$16.60				
	 Green	<a href="#">CSW-BIDLB-2E10</a>	\$16.60				
	 Yellow	<a href="#">CSW-BIDLB-3E10</a>	\$16.60				
	 Blue	<a href="#">CSW-BIDLB-4E10</a>	\$16.60				

Note: 1) Blocks specific for mounting in base or PBW plastic control stations.

## Mounting in Flanges or Control Stations

### Plastic Legend Plates

Image	Description	Standard packing	Catalog Number	Price	Multiplier
 0.006 kg <sup>2)</sup>	Black and red legend plates 27 x 18 mm without engraving	5 pieces	AP30	\$8.00	Z5
 0.006 kg <sup>2)</sup>	Translucent legend plates 27x18 mm without engraving	5 pieces	AP30T	\$8.00	Z5







### Emergency-Stop Plate

Image	Description	Standard packing	Catalog Number	Price	Multiplier
 0.009 kg	Legend plate for emergency pushbutton.	1 piece	APEC-02	\$7.50	Z5









### Fixing Ring Tool

Image	Description	Standard packing	Catalog Number	Price	Multiplier
 0.017 kg	Tool for the insertion/removal of the CSW pushbuttons, pilot lights and selector switches fixing ring	1 piece	CPAW	\$5.60	Z5

### Spare Lens for Pilot Lights

Image	Description	Color	Standard packing	Catalog Number	Price	Multiplier
 0.004 kg <sup>2)</sup>	Lens to replace the pilot lights color		5 pieces	ALSD0	\$10.50	Z5
				ALSD1	\$10.50	
				ALSD2	\$10.50	
				ALSD3	\$10.50	
				ALSD4	\$10.50	

### Engraved Pushbutton Caps<sup>1)</sup>

Image	Description	Function	Standard packing	Catalog Number	List Price	Multiplier
	Engraved caps for flush pushbuttons <sup>1)</sup>		5 pieces	ACB1-30	\$1.50	Z5
				ACB5-31		
				ACB5-32		
				ACB5-33		
				ACB5-34		
				ACB5-35		
				ACB4-37		







Notes: 1) Other engraving options under request;  
2) Unitary weight.

# Pushbuttons and Pilot Lights







Accessories for CSW (22mm)

## Common Accessories - Mounting in Flanges or Control Stations

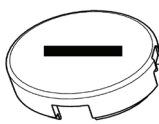
### Pushbutton Caps

Image	Description	Color	Standard packing	Catalog Number	Price	Multiplier
 0.005 kg <sup>2)</sup>	Caps to replace the flush pushbuttons colors		5 pieces	<a href="#">ACB0</a>	<b>\$.90</b>	Z5
				<a href="#">ACB1</a>	<b>\$.90</b>	
				<a href="#">ACB2</a>	<b>\$.90</b>	
				<a href="#">ACB3</a>	<b>\$.90</b>	
				<a href="#">ACB4</a>	<b>\$.90</b>	
			<a href="#">ACB5</a>	<b>\$.90</b>		
		All six colors	6 pieces	<a href="#">ACB</a>	<b>\$.90</b>	

### Engraved Illuminated Pushbutton Caps<sup>1)</sup>

Image	Description	Color	Standard packing	Catalog Number	Price	Multiplier
	Engraved internal caps for flush illuminated and extended illuminated pushbutton <sup>1)</sup>	 Stop	5 pieces	<a href="#">ALBI-30</a>	<b>\$2.00</b>	Z5
		 Start		<a href="#">ALBI-31</a>		
		 Rectilinear movement		<a href="#">ALBI-32</a>		
		 Clockwise rotation		<a href="#">ALBI-33</a>		
		 Counter-clockwise rotation		<a href="#">ALBI-34</a>		
		 Feed		<a href="#">ALBI-35</a>		

### Hole Plug

Image	Description	Standard packing	Catalog Number	Price	Multiplier
 0.010 kg <sup>2)</sup>	Round plug for unused Ø22 mm holes	5 pieces	<a href="#">ATR</a>	<b>\$24.50</b>	Z5

### Single Pushbutton Protection

Image	Description	Standard packing	Catalog Number	Price	Multiplier
 0.010 kg <sup>2)</sup>	Silicon additional protective cover for flush pushbuttons (BF) and pilot lights (SD)	5 pieces	<a href="#">APBF</a>	<b>\$38.50</b>	Z5
	Silicon additional protective cover for illuminated flush pushbuttons (BFI), illuminated extended pushbuttons (BSI) and extended pushbuttons (BS)		<a href="#">APBI</a>	<b>\$49.50</b>	Z5

### Double Pushbutton Protection<sup>3)</sup>

Image	Description	Standard packing	Catalog Number	Price	Multiplier
 0.010 kg <sup>2)</sup>	Silicon protective cover for double pushbuttons CSW-BD (IP40) to ensure IP66 Degree of Protection	5 pieces	<a href="#">APBD</a>	<b>\$15.60</b>	Z5

Notes: 1) Other engraving options under request  
 2) Unitary weight  
 3) Not compatible with PBW Control Station.

### Plastic Engraved 27 x 18 mm Legend Plates<sup>1)</sup>



Standard packing  
5 pieces

0.020 kg<sup>3)</sup>

General Information

Circuit Protection

Disconnect Switches

Motor Protectors

Contactors

Overloads

Enclosed Starters

Relays

Pushbuttons and Pilot Lights

Terminal Blocks

Power Factor Correction

Appendix A

Appendix B

### Single pushbuttons and pilot lights

Catalog Number	Engraving	Price	Multiplier
AP30-204	HAND	\$1.75	Z5
AP30-205	AUTO	\$1.75	
AP30-18 <sup>2)</sup>	STOP	\$1.75	
AP30-11	OPEN	\$1.75	
AP30-01	CLOSE	\$1.75	
AP30-19	UP	\$1.75	
AP30-02	DOWN	\$1.75	
AP30-04	FORWARD	\$1.75	
AP30-15	REVERSE	\$1.75	
AP30-10	ON	\$1.75	
AP30-132	OFF	\$1.75	
AP30-12	POWER ON	\$1.75	
AP30-14	RESET	\$1.75	
AP30-17	START	\$1.75	
AP30-16	RUN	\$1.75	
AP30-206	FAST	\$1.75	
AP30-207	SLOW	\$1.75	
AP30-208	RIGHT	\$1.75	
AP30-209	LEFT	\$1.75	
AP30-210	INCH	\$1.75	
AP30-03 <sup>2)</sup>	EMERGENCY STOP	\$1.75	
AP30-05	JOG	\$1.75	
AP30-06	JOG FORWARD	\$1.75	
AP30-07	JOG REVERSE	\$1.75	
AP30-08	LOWER	\$1.75	
AP30-13	RAISE	\$1.75	
AP30-147	FAULT	\$1.75	
AP30-129	MANUAL	\$1.75	

### 2-position selector switches

Catalog Number	Engraving		Price	Multiplier
AP30-21	HAND	AUTO	\$1.75	Z5
AP30-27	START	STOP	\$1.75	
AP30-20	FOR	REV	\$1.75	
AP30-22	JOG	RUN	\$1.75	

Catalog Number	Engraving		Price	Multiplier
AP30-24	OFF	ON	\$1.75	Z5
AP30-25	OPEN	CLOSE	\$1.75	
AP30-26	RUN	JOG	\$1.75	

### 3-position selector switches

Catalog Number	Engraving			Price	Multiplier
AP30-30	FOR	OFF	REV	\$1.75	Z5
AP30-32	MAN	OFF	AUTO	\$1.75	
AP30-33	OPEN	OFF	AUTO	\$1.75	
AP30-34	OPEN	OFF	CLOSE	\$1.75	

Notes: 1) Other engraving options under request;  
2) Red plate engraved in white;  
3) Unitary weight.

# Pushbuttons and Pilot Lights

CSW Series (22mm)

## Technical Data

### Pushbuttons, Selector Switches and Pilot Lights

Applicable standards	IEC 60947-5-1, VDE 0660, UL 508, CENELEC EN 50007, ISO 13850 (EN 418), IEC 60947-5-5
Certifications	CE, cULus, BV, IRAM, PCT, RCC, ICONTEC
Degree of protection	IP66 and IP40 (CSW-BD) according to IEC 60529 Type 1, 2, 3, 3R, 3S, 4, 4X, 5, 12, 12K y 13 according to UL 508

#### Mechanical lifespan

Pushbuttons	3 x 10 <sup>6</sup> operations
Pushbuttons CSW-BEG/EY/CT/CY	3 x 10 <sup>5</sup> operations
Pushbuttons CSW2-BD/BT	2 x 10 <sup>6</sup> operations
Emergency pushbuttons CSW-BESG/P/Y	1 x 10 <sup>5</sup> operations
Selector switches	1 x 10 <sup>6</sup> operations

### Contact Block

Applicable standards	IEC 60947-5-1, VDE 0660, UL 508, CENELEC EN 50007, ISO 13850 (EN 418), IEC 60947-5-5
Certifications	CE, cULus, BV, IRAM, PCT, RCC, ICONTEC
Rated insulation voltage U <sub>i</sub>	690 V
Rated impulse voltage U <sub>imp</sub>	4 kV
Degree of protection (IEC 60529)	IP20
Conventional thermal current I <sub>th</sub>	10 A

#### Electrical performance according to IEC 60947-5-1

	BC....-CSW		BCM01-CSW	
	U <sub>e</sub> (V ac)	I <sub>e</sub> (A)	U <sub>e</sub> (V ac)	I <sub>e</sub> (A)
Utilization category AC-15	24	10	24	6
	48	10	48	6
	60	10	60	6
	110	6	110	6
	220	3	220	3
	380	2	380	2
	500	1,5	500	1,5
	600	1,2	600	1,2
Utilization category DC-13	U <sub>e</sub> (V dc)	I <sub>e</sub> (A)	U <sub>e</sub> (V dc)	I <sub>e</sub> (A)
	24	2,5	24	2,5
	48	1,4	48	1,4
	60	1	60	1
	110	0,55	110	0,55
	220	0,27	220	0,27
	300	0,2	300	0,2
600	0,1	600	0,1	

Performance according to UL and CSA	AC / Heavy Duty (A600) e DC / Standard Duty (R300)	-
Contact resistance (IEC 60255)	≤ 25m Ω	
Potection against short circuit (IEC 60269-1/IEC 60269-3)	6 A fuse / 690 V gL/gG (1 kA) 16 A Miniature Circuit Breaker (MDW-B16)	6 A fuse / 500 V gL/gG (0.5 kA) 6 A Miniature Circuit Breaker (MDW-B6)
Electric shock protection (IEC 60536)	Class II	
Terminal capacity (wire/cable with or without terminal)	Minimum (1 x 0,5 mm <sup>2</sup> ) and maximum (2 x 2,5 mm <sup>2</sup> )	
Tightening torque	0,8 N.m	
Ambient temperature allowed	-25 °C...+70 °C	
Mechanical shock resistance	No damage or disassembling up to 100 g (1/2 senoid 11 rms, according to MIL 202 B method 202 A)	
Vibration resistance (IEC 60068-2-6)	16 g for a frequency range of 40 to 500 Hz. Maximum displacement 0.75 mm (peak to peak)	

## Technical Data

### Illumination Blocks with Integrated LED

Applicable standards	IEC 60947-5-1, UL 508
Operation voltage range	0,85...1,10 x U <sub>0</sub>
Degree of protection (IEC 60529)	IP20
Energy consumption (V ac/dc)	10 mA
Rated impulse voltage U <sub>i</sub> (IEC 60947-1)	2,5 kV
Ambient temperature allowed	- 25 °C...+70 °C
Average lifespan	100,000 hours
Brightness	Red 70 mcd
	Yellow 115 mcd
	White 275 mcd
	Blue 64 mcd Green 150 mcd
Terminal capacity (wire/cable with or without terminal)	Minimum (1 x 0,5 mm <sup>2</sup> ) and maximum (2 x 2,5 mm <sup>2</sup> )
Tightening torque	0,8 N.m

### Special Blocks (Illumination, Sockets, Voltage Reduction)

Applicable standards	IEC 60947-5-1, UL 508
Degree of protection (IEC 60529)	IP20
Rated impulse voltage U <sub>i</sub> (IEC 60947-1)	4 kV
Ambient temperature allowed	- 25 °C...+70 °C
Terminal capacity (wire/cable with or without terminal)	Minimum (1 x 0,5 mm <sup>2</sup> ) y maximum (2 x 2,5 mm <sup>2</sup> )
Tightening torque	0,8 N.m

### Decentralized Control Stations

Applicable standards	IEC 60947-5-1, IEC 50102, IEC 60529, UL 508, UL 50
Certifications	CE
Degree of protection (IEC 60529)	IP66 (NEMA 4X)
Ambient temperature allowed	-25 °C...+70 °C
Material	Polycarbonate (cover and base)
Cover color	Gray (RAL 7035) or Yellow (RAL 1003)
Base color	Black (RAL 9005)
Cable entry holes	ØM20 / PG13,5 / 1/2" and ØM16 / 3/8"
Use in ambient	External (UV rays) or internal

# Pushbuttons and Pilot Lights

## Assembly Configurations

### Maximum Recommended Configuration of Contact Blocks for Each type of Head and Flange

Type of head	Pushbuttons	Pushbuttons	Selectors	Illuminated selectors
Reference	CSW-BF, CSW-BGA	CSW-BC, CSW-BS	CSW-CK, CSW-CA, CSW-CY	CSW-CKI
Maximum number of contact blocks	Max 6	Max 6	Max 6	Max 4
AF3F flange (3 positions)	 or			 or

Emergency pushbutton	Pushbutton	Illuminated pushbutton	Double pushbutton	Illuminated double pushbutton	Triple pushbutton
CSW-BESG, CSW-BESP, CSW-BESY	CSW-BEG, CSW-BEY, CSW-BCT, CSW-BCY	CSW-BCI, CSW-BD, CSW-BFI, CSW-BSI	CSW2-BDF, CSW2-BDS	CSW2-BDFI, CSW2-BDSI	CSW2-BTF, CSW2-BTS
Max 4	Max 6	Max 6	Max 4	Max 4	Max 7
 or					



Contact Block BC10F-CSW  
Contact Block BC01F-CSW



Illumination Block BIDLF



Position not allowed



### Dimensions (mm)

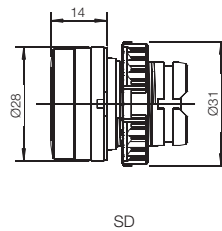
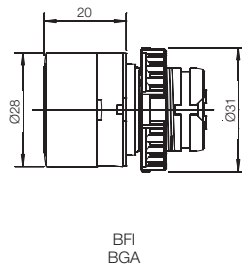
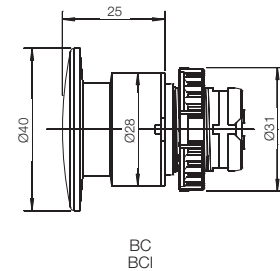
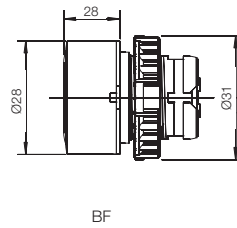
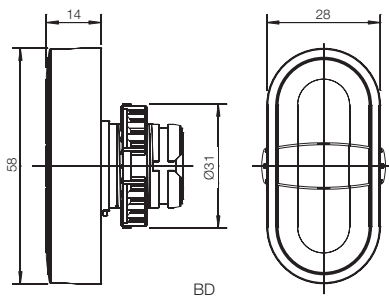
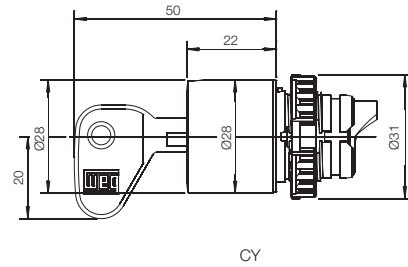
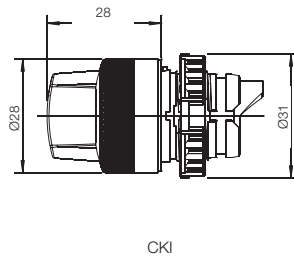
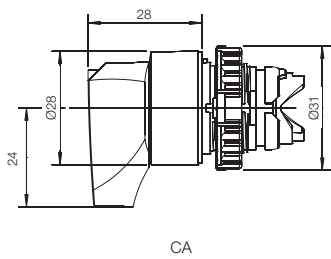
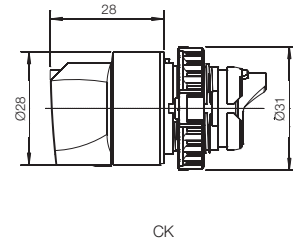
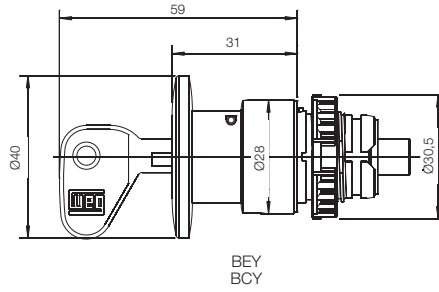
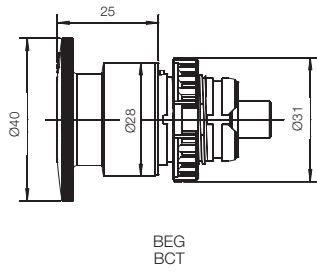

General Information
Circuit Protection
Disconnect Switches
Motor Protectors
Contactors
Overloads
Enclosed Starters
Relays
<b>Pushbuttons and Pilot Lights</b>
Terminal Blocks
Power Factor Correction
Appendix A
Appendix B



# Pushbuttons and Pilot Lights

CSW Series (22mm)

## Dimensions (mm)

General Information

Circuit Protection

Disconnect Switches

Motor Protectors

Contactors

Overloads

Enclosed Starters

Relays

Pushbuttons and Pilot Lights

Terminal Blocks

Power Factor Correction

Appendix A

Appendix B

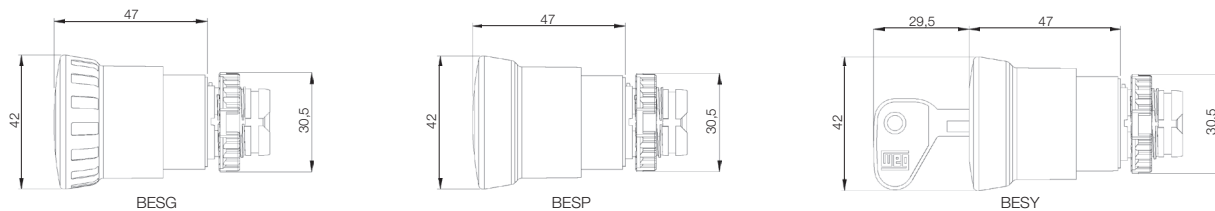
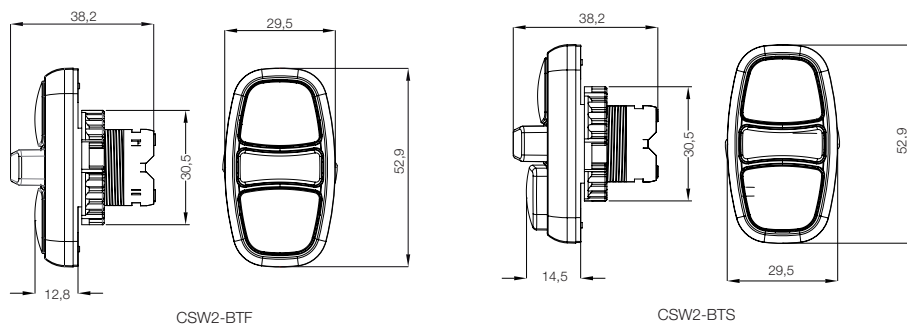
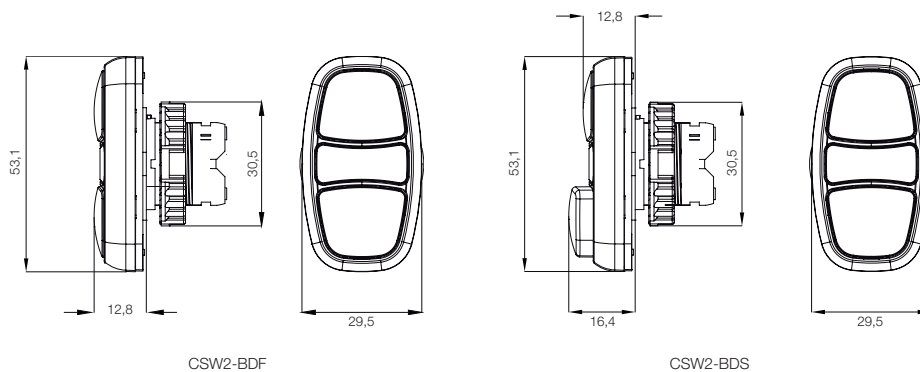

### Dimensions (mm)

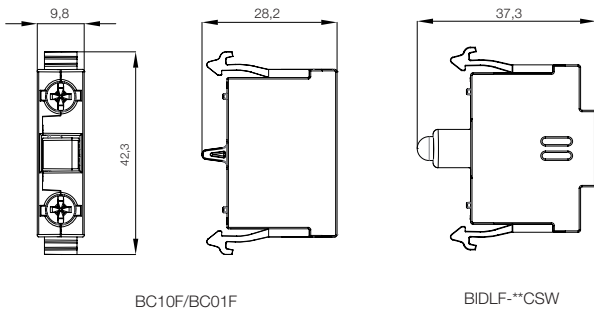

BC10F/BC01F

BIDLF-CSW

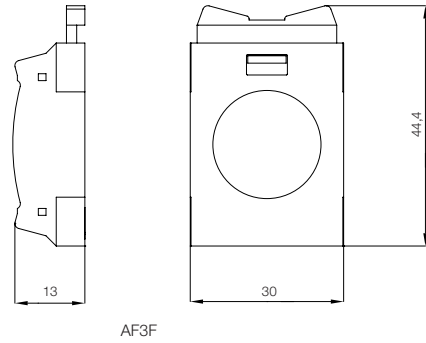

AF3F

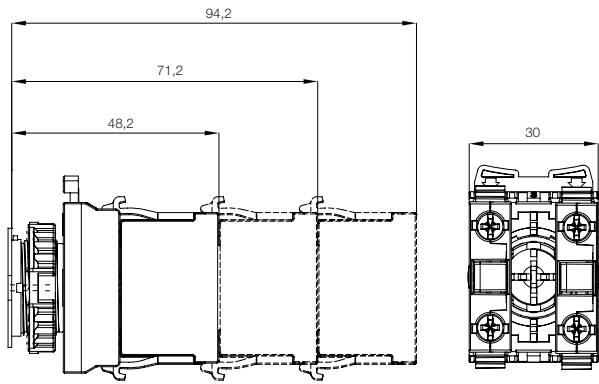

AF3F + 1...3x Contact Block BC\_F

AF3F + Contact Block

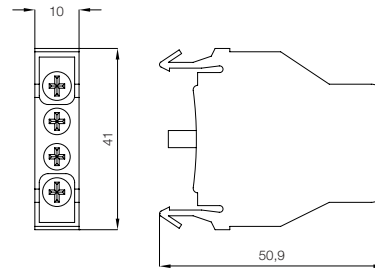

BC11/BC20/BC02

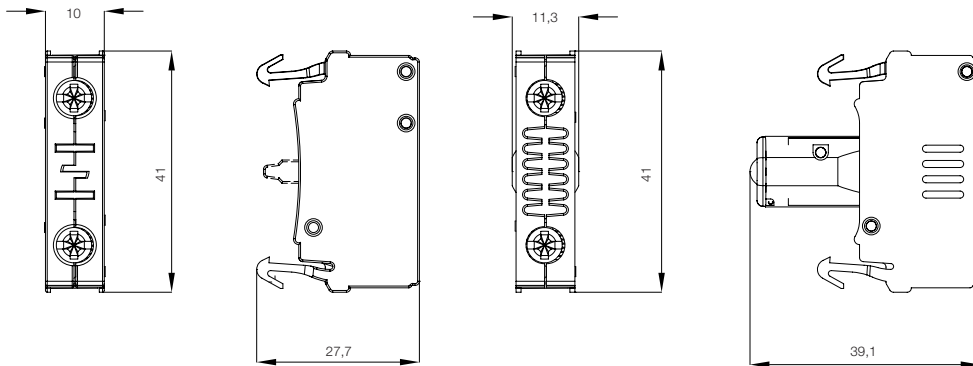

BC10/BC01/BCA10/BCR01

BIDL

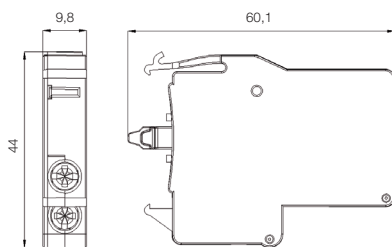

BCM01

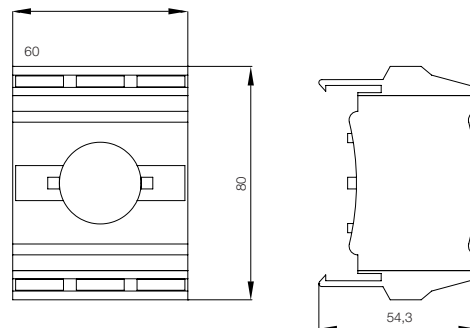

BR-3P

General Information

Circuit Protection

Disconnect Switches

Motor Protectors

Contactors

Overloads

Enclosed Starters

Relays

Pushbuttons and Pilot Lights

Terminal Blocks

Power Factor Correction

Appendix A

Appendix B

# Pushbuttons and Pilot Lights

CSW Series (22mm)

## Dimensions (mm)

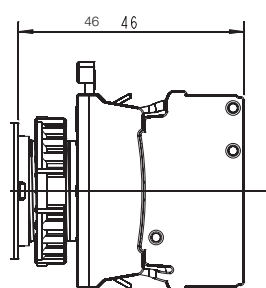
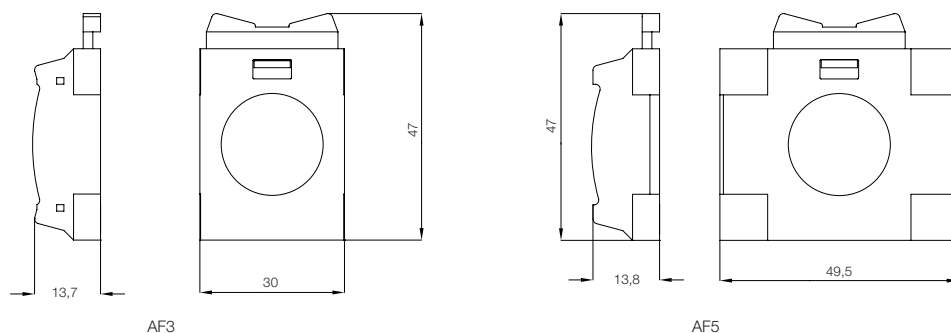

AF5 + BC01/10  
BCA10  
BCR01

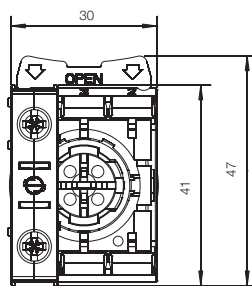

AF3 + BC01/10  
BCA10  
BCR01

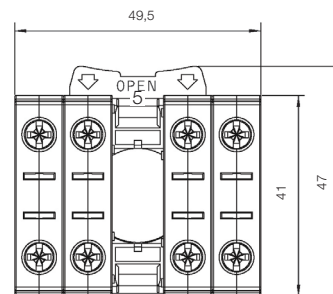

BF + AF5 + BC01/10  
BCA10  
BCR01

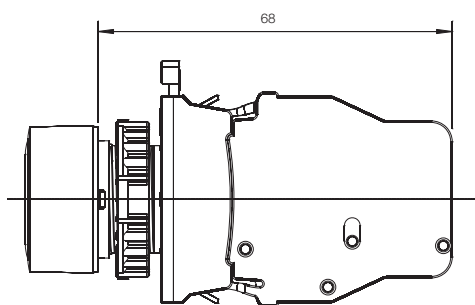

AF3/5 + BC11/20/02

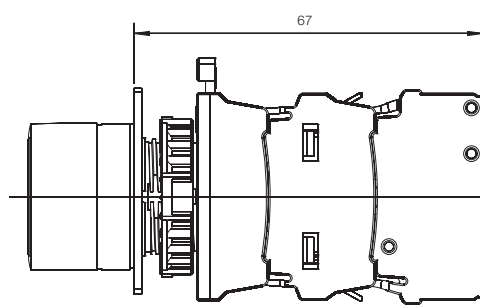

AF3 + BR-3P + BIDL

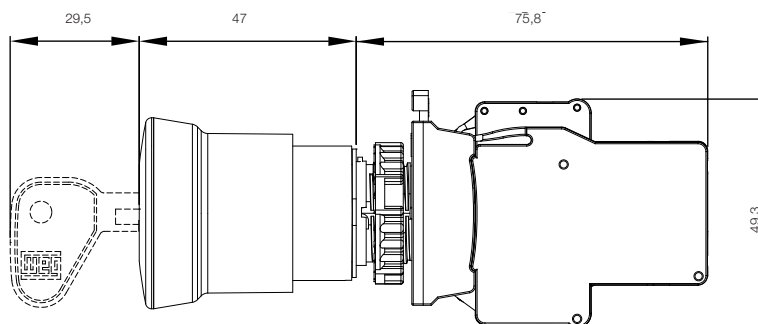
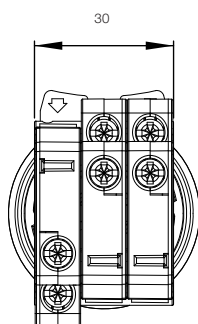

BES + BCM01-CSW

General Information

Circuit Protection

Disconnect Switches

Motor Protectors

Control

Enclosed Starters

Relays

Pushbuttons and Pilot Lights

Terminal Blocks

Power Factor Correction

Appendix A

Appendix B

### Dimensions (mm)

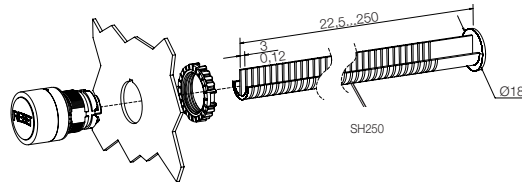

CSW-BHF437

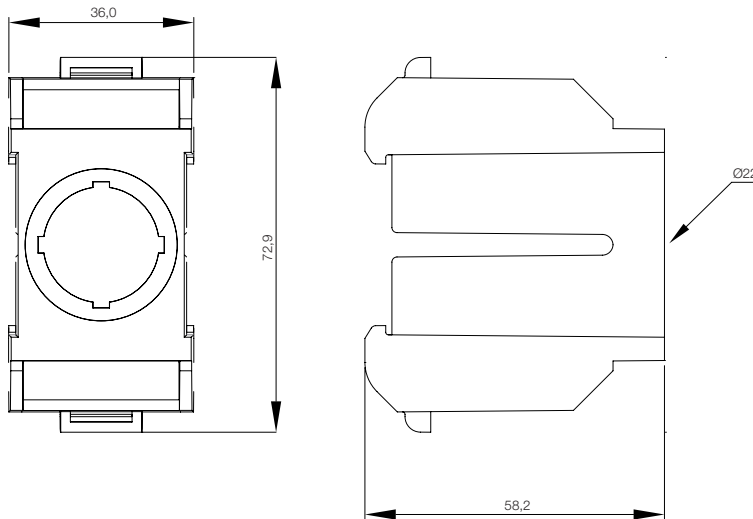
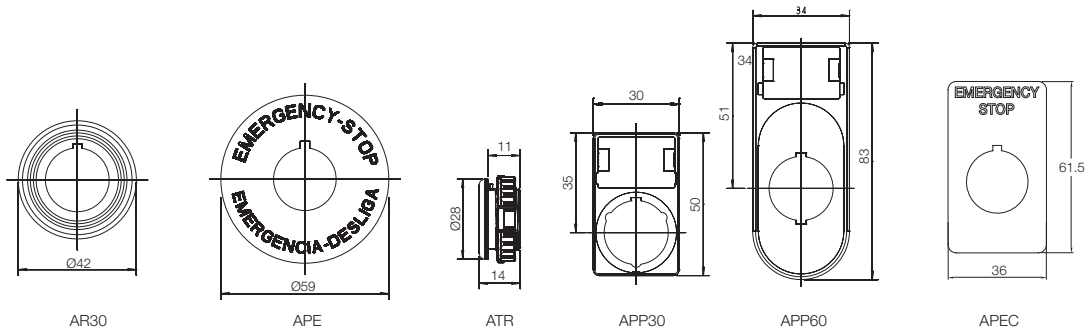
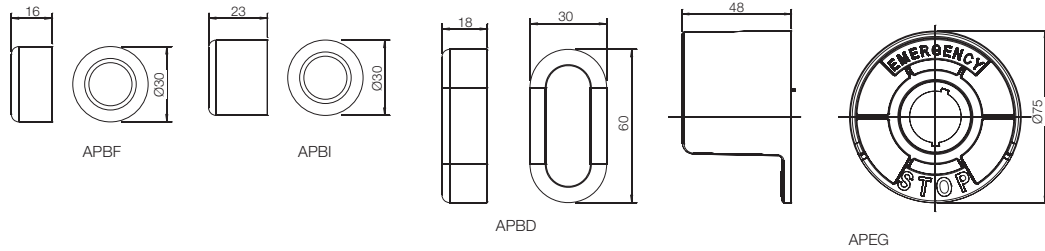

DRCSWA

- General Information
- Circuit Protection
- Disconnect Switches
- Motor Protectors
- Contactors
- Overloads
- Enclosed Starters
- Relays
- Pushbuttons and Pilot Lights
- Terminal Blocks
- Power Factor Correction
- Appendix A
- Appendix B

# Pushbuttons and Pilot Lights

CSW Series (22mm)

## Dimensions (mm)

### Bottom/Top

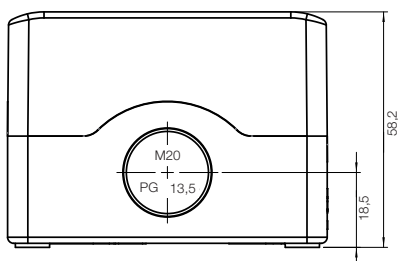

### Side

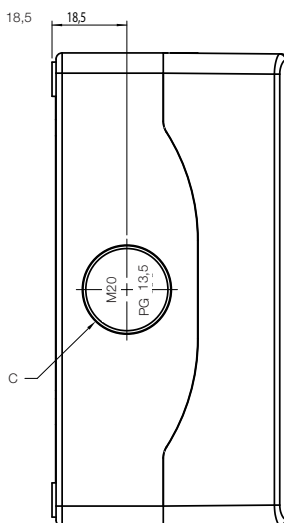

### Base

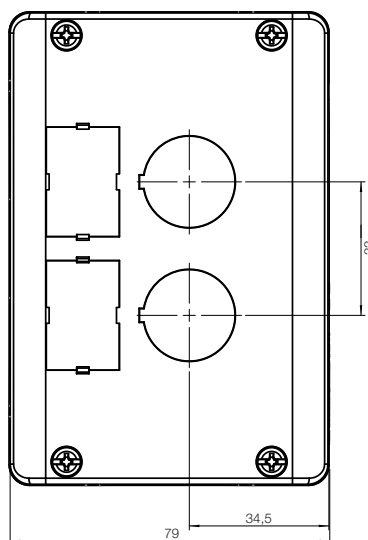
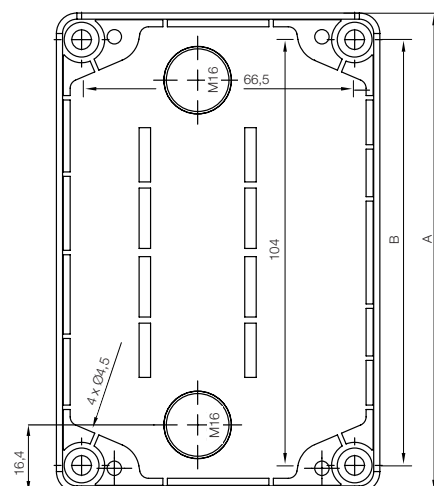

PBW decentralized control station

Number of holes	A	B	Cable entry holes									
			Bottom		Top		Side		Base			
			Size	Cable gland thread length	Size	Cable gland thread length	Size	Cable gland thread length	Size	Cable gland thread length		
1	74	66,7	1 x ØM20 ØPG13,5 Ø½ NPT	9 to 16 mm	1 x ØM20 ØPG13,5 Ø½NPT	9 to 16 mm	1 x	ØM20 ØPG13,5 Ø½NPT	9 to 16 mm	2 x	ØM16 ØPG9	7 to 10 mm
2	104	117					2 x					
3	137	150										
4	170	183										
5	203	216										
6	236	249										

### Installation Distances (mm)

#### AF3/AF3F Flange

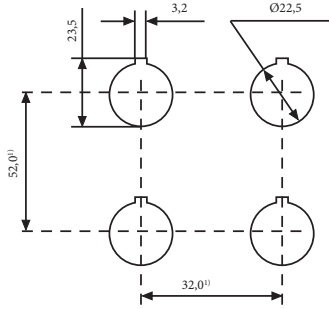

#### AF5 Flange

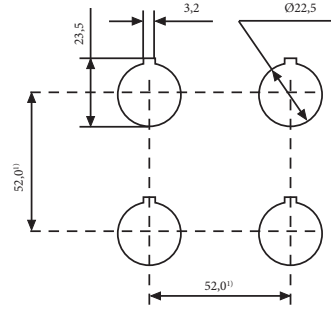

#### PBW Control Stations

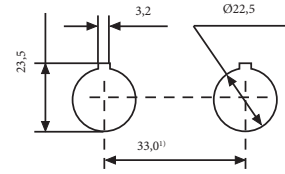

Note: 1) Minimum distance to use Pushbuttons (Flush/Extended/Guarded) or Selectors (Knob). To use others Pushbuttons or Selectors is necessary to evaluate the head dimensions.

- General Information
- Circuit Protection
- Disconnect Switches
- Motor Protectors
- Contactors
- Overloads
- Enclosed Starters
- Relays
- Pushbuttons and Pilot Lights**
- Terminal Blocks
- Power Factor Correction
- Appendix A
- Appendix B

# Pushbutton and Pilot Light - CSW30 Series (30mm)

The WEG 30mm pushbuttons, selector switches, and indicators have been designed to offer the ruggedness required for severe industrial applications and environments. These modular devices offer superior quality at an affordable price.

Our hazardous duty series CSW30H also offers a wide selection of operators and pilot devices for hazardous duty applications (Class 1, Division, 2 and Zone 2). This series offers a wide selection of hermetically sealed reed and factory sealed contact blocks for superior corrosion resistance.



## Standard Features

- NEMA 4, IP65 Rated;
- Fits 1-13/64 (30.5mm) hole without notch required
- Contact blocks snap-in (fast & easy assembly)
- Up to 8 contact blocks for non-illuminated operators and up to 4 contact blocks for illuminated operators
- LED lamps with built-in leakage protection
- Same simple part numbering system as 22mm series

### Pushbuttons

Types

- BF - Flush
- BS - Extended
- BC - Mushroom
- BGA - Recessed
- BGAI - Illuminated Recessed
- BSI - Illuminated Extended
- BCI - Illuminated Mushroom

**MULTIPLIER FOR CSW-30 SERIES  
- Z55**

### CSW30- \_\_\_\_\_

\_\_\_\_\_ Voltage (see Voltage Code) For illuminated only  
 \_\_\_\_\_ Color (see Color Code)

**NON-ILLUMINATED FLUSH**

CSW30 - \_\_\_\_\_

- BF0
- BF1
- BF2
- BF3
- BF4
- BF5

**LIST PRICE**  
\$26

**NON-ILLUMINATED (Extended)**

CSW30 - \_\_\_\_\_

- BS0
- BS1
- BS2
- BS3
- BS4
- BS5

**LIST PRICE**  
\$26

**MUSHROOM (40mm HEAD)**

CSW30 - \_\_\_\_\_

- BC1
- BC2
- BC5

**LIST PRICE**  
\$37

**NON-ILLUMINATED RECESSED**

CSW30 - \_\_\_\_\_

- BGA0
- BGA1
- BGA2
- BGA3
- BGA4
- BGA5

**LIST PRICE**  
\$32

\* Illuminated operators are supplied with LED block. To complete selection, replace "\*" with desired voltage: E26 (24Vac/Vdc), D61 (120Vac/Vdc) or D66 (240Vac/Vdc).

**ILLUMINATED EXTENDED**

CSW30 - \_\_\_\_\_\*

- BSI0
- BSI1
- BSI2
- BSI3
- BSI4

**LIST PRICE**  
\$93

**ILLUMINATED MUSHROOM (40mm HEAD)**

CSW30 - \_\_\_\_\_\*

- BCI0
- BCI1
- BCI2
- BCI3
- BCI4

**LIST PRICE**  
\$100

**ILLUMINATED RECESSED**

CSW30 - \_\_\_\_\_\*

- BGAI0
- BGAI1
- BGAI2
- BGAI3
- BGAI4

**LIST PRICE**  
\$100

### Emergency-Stop Pushbuttons

Types

G - Twist release

### CSW- \_\_\_\_\_

E-STOP - TWIST RELEASE	E-STOP - PUSH PULL
<ul style="list-style-type: none"> <li>● CSW30-BEG</li> <li>● CSW30-BEG2</li> </ul> <p style="text-align: right;"><b>LIST PRICE</b> \$81</p>	<ul style="list-style-type: none"> <li>● CSW30-BEP</li> <li>● CSW-30-BEP2</li> </ul> <p style="text-align: right;"><b>LIST PRICE</b> \$75</p>

Note: Contact blocks ordered separately. See page 313.

### Pilot Lights

### CSW30- \_\_\_\_\_

\_\_\_\_\_ Voltage (see Voltage Code)  
 \_\_\_\_\_ Color (see Color Code)

**PILOT LIGHTS**

CSW30 - \_\_\_\_\_\*

- SD0
- SD1
- SD2
- SD3
- SD4

**LIST PRICE**  
\$89

### Code Chart

Color	Clear/White	Red	Green	Yellow	Blue	Black
Code	0	1	2	3	4	5
Symbol	○	●	●	●	●	●

LED Block Voltage	
E26	24Vac/Vdc
D61	120Vac/Vdc
D66	240Vac/Vdc

- General Information
- Circuit Protection
- Disconnect Switches
- Motor Protectors
- Contactors
- Overloads
- Enclosed Starters
- Relays
- Pushbuttons and Pilot Lights
- Terminal Blocks
- Power Factor Correction
- Appendix A
- Appendix B



# Pushbuttons and Pilot Lights

## CSW Series (30mm)

### Selector Switches

Types











- CK** - Knob
- CA** - Lever
- CY** - Key

# CSW30-

- No. of Positions
- 2** - Two positions
  - 3** - Three positions
  - 4** - Four positions

- Angle
- 45 - 45°
  - 90 - 90°

- Handle
- F - Maintained
  - R - Spring return
  - RE - Spring return from left
  - RD - Spring return from right

KNOB	LEVER	with KEY <sup>(1)</sup>	POSITION	DIAGRAM
 LIST PRICE Maintained <b>\$39</b> Spring Return <b>\$57</b>	 LIST PRICE Maintained <b>\$39</b> Spring Return <b>\$57</b>	 LIST PRICE Maintained <b>\$110</b> Spring Return <b>\$128</b>		
<b>CSW30-CK2F90</b>	<b>CSW30-CA2F90</b>	<b>CSW30-CY2F90</b>		1
<b>CSW30-CK2R90</b>	<b>CSW30-CA2R90</b>	<b>CSW30-CY2R90</b>		1
<b>CSW30-CK3F45</b>	<b>CSW30-CA3F45</b>	<b>CSW30-CY3F45</b>		2
<b>CSW30-CK3R45</b>	<b>CSW30-CA3R45</b>	<b>CSW30-CY3R45</b>		2
<b>CSW30-CK3RE45</b>	<b>CSW30-CA3RE45</b>	<b>CSW30-CY3RE45</b>		2
<b>CSW30-CK3RD45</b>	<b>CSW30-CA3RD45</b>	<b>CSW30-CY3RD45</b>		2
<b>CSW30-CK4F18</b>	<b>CSW30-CA4F18</b>	<b>CSW30-CY4F18</b>		3

1) Key is released on any position. Consult WEG for other configuration.

2) Contact blocks ordered separately

HANDLE POSITION		Auxiliary Contact	Mouting Position
I	II		
0	X	NO	Either
X	0	NC	Either
0	X	early make	Either
X	0	late break	Either

X = CLOSED  
0 = OPEN

HANDLE POSITION			Auxiliary Contact	Mouting Position
I	0	II		
X	0	0	NO	Left
0	0	X	NO	Right
0	X	0	NC	Either
X	0	X	early make	Either
0	X	X	late break	Left
X	X	0	late break	Right

HANDLE POSITION				Auxiliary Contact	Mouting Position
I	II	III	IV		
X	0	0	0	NO	Left
0	0	0	X	NO	Right
0	0	X	0	NC	Left
0	X	0	0	NC	Right
X	X	0	X	early make	Left
X	0	X	X	early make	Right
0	X	X	X	late break	Left
X	X	X	0	late break	Right

### Auxiliary Contacts

Our standard contact blocks are color coded for easy circuit identification to minimize wiring errors. WEG's contact blocks are stackable up to 4 deep (for a total of up to 8 circuits per operator) without the need of any additional accessory. Combining different contact blocks types enable several functions to be achieved.



#### CONTACT BLOCKS

**Normally Open**  
BC10-CSW30

LIST PRICE  
**\$13**

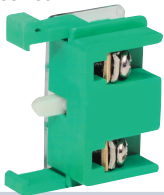

**Normally Closed**  
BC01-CSW30

LIST PRICE  
**\$13**



**Early Make**  
BCA10-CSW30

LIST PRICE  
**\$17**



**Late Break**  
BCR01-CSW30

LIST PRICE  
**\$17**



### Accessories

#### CLAMP RING WRENCH

CPAW30



LIST PRICE  
**\$30**

Simplifies the tightening or loosening of polyester and aluminum 1-3/8" clamp rings.

#### 30MM HOLE PLUG

ATR30



LIST PRICE  
**\$25**

NEMA 4X rated plug to seal up unwanted panel holes.

#### THRUST AND TRIM WASHER

CSW30-TTW

LIST PRICE

**\$4**

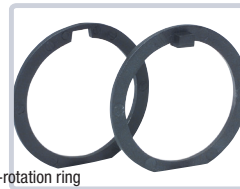

Anti-rotation ring

#### GUARD & LOCK-OFF ATTACHMENT



WEG P/N	Description	List
CSW30-GAPB	30MM GUARD ATTACHMENT FOR MAINTAINED PUSH BUTTONS	<b>\$40</b>
CSW30-L01	30MM LOCK OFF ATTACHMENT FOR STANDARD EXTENDED CAP	<b>\$32</b>
CSW30-L02	30MM LOCK OFF ATTACHMENT FOR STANDARD MOMENTARY MUSHROOM CAP	<b>\$32</b>
CSW30-L03	30MM LOCK OFF ATTACHMENT FOR PUSH-PULL MTD MUSHROOM CAP OR PUSH MTD EXTENDED CAP	<b>\$32</b>
CSW30-L04	30MM LOCK OFF ATTACHMENT FOR MOST PUSH BUTTONS AND SELECTOR SWITCHES	<b>\$50</b>

#### EMERGENCY PLATE

APE30-03



LIST PRICE  
**\$8.30**

#### PANEL GASKETS

CSW30-PG2 (1/16")  
CSW30-PG6 (3/16")



LIST PRICE  
**\$10**

General Information

Circuit Protection

Disconnect Switches

Motor Protectors

Contactors

Overloads

Enclosed Starters

Relays

Pushbuttons and Pilot Lights

Terminal Blocks

Power Factor Correction

Appendix A

Appendix B

# Pushbuttons and Pilot Lights

CSW Series (30mm)

## Special Operators

POTENTIOMETER

CSW30-POT\_W

LIST PRICE \$145



CSW30-POT	W	Resistance	
		1 - 1kΩ	10 - 10kΩ
		2 - 2kΩ	50 - 50kΩ
		5 - 5kΩ	

RESET

CSW30-RSBW

LIST PRICE \$22



Note: Plunger included as standard.

PUSH ON / PUSH OFF BLOCK

BR3P-CSW30

LIST PRICE \$37

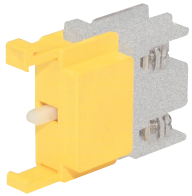

WOBBLE STICK

CSW30-WS

LIST PRICE \$65



BOOTED CABLE PULL

CSW30-CPBT

LIST PRICE \$130

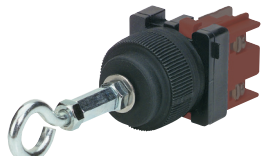

## LED Bulbs

Catalog Number	Description	List Price
<a href="#">CSW30-BIDL3E26</a>	Yellow 24vac/24vdc	\$28
<a href="#">CSW30-BIDL4E26</a>	Blue 24vac/24vdc	\$28
<a href="#">CSW30-BIDL2E26</a>	Green 24vac/24vdc	\$28
<a href="#">CSW30-BIDL1E26</a>	Red 24vac/24vdc	\$28
<a href="#">CSW30-BIDL0E26</a>	White 24vac/24vdc	\$28
<a href="#">CSW30-BIDL3D61</a>	Yellow 120vac/120vdc	\$28
<a href="#">CSW30-BIDL4D61</a>	Blue 120vac/120vdc	\$28
<a href="#">CSW30-BIDL2D61</a>	Green 120vac/120vdc	\$28
<a href="#">CSW30-BIDL1D61</a>	Red 120vac/120vdc	\$28
<a href="#">CSW30-BIDL0D61</a>	White 120vac/120vdc	\$28



Replacement LED bulbs for 240Vac/Vdc illuminated operators are the "E26" (24Vac/Vdc) bulbs. Please refer to the correct color when ordering.

General Information

Circuit Protection

Disconnect Switches

Motor Protectors

Contactors

Overloads

Enclosed Starters

Relays

Pushbuttons and Pilot Lights

Terminal Blocks

Power Factor Correction

Appendix A

Appendix B

### Engraved Legend Plates

Catalog Number	Marking	Description	List Price Package with 1 unit
<b>For Pushbuttons &amp; Indicating Lights</b>			
APP30S-01	Close	30mm Legend Plate & Holder - Close	\$6
APP30S-02	Down	30mm Legend Plate & Holder - Down	\$6
APP30S-03	Emergency Stop	30mm Legend Plate & Holder - Emergency Stop	\$6
APP30S-04	Forward	30mm Legend Plate & Holder - Forward	\$6
APP30S-05	Jog	30mm Legend Plate & Holder - Jog	\$6
APP30S-06	Jog Forward	30mm Legend Plate & Holder - Jog Forward	\$6
APP30S-07	Jog Reverse	30mm Legend Plate & Holder - Jog Reverse	\$6
APP30S-08	Lower	30mm Legend Plate & Holder - Lower	\$6
APP30S-09	Off	30mm Legend Plate & Holder - Off	\$6
APP30S-10	On	30mm Legend Plate & Holder - On	\$6
APP30S-11	Open	30mm Legend Plate & Holder - Open	\$6
APP30S-12	Power On	30mm Legend Plate & Holder - Power On	\$6
APP30S-13	Raise	30mm Legend Plate & Holder - Raise	\$6
APP30S-14	Reset	30mm Legend Plate & Holder - Reset	\$6
APP30S-15	Reverse	30mm Legend Plate & Holder - Reverse	\$6
APP30S-16	Run	30mm Legend Plate & Holder - Run	\$6
APP30S-17	Start	30mm Legend Plate & Holder - Start	\$6
APP30S-18	Stop	30mm Legend Plate & Holder - Stop	\$6
APP30S-19	Up	30mm Legend Plate & Holder - Up	\$6
APP30S-147	Fault	30mm Legend Plate & Holder - Fault	\$6
APP30S-100	Auto	30mm Legend Plate & Holder - Auto	\$6
APP30S-101	Fast	30mm Legend Plate & Holder - Fast	\$6
APP30S-102	Hand	30mm Legend Plate & Holder - Hand	\$6
APP30S-103	Low	30mm Legend Plate & Holder - Low	\$6
APP30S-104	Manual	30mm Legend Plate & Holder - Manual	\$6
APP30S-105	Out	30mm Legend Plate & Holder - Out	\$6
APP30S-106	Overload	30mm Legend Plate & Holder - Overload	\$6
APP30S-107	Push-to-Reset	30mm Legend Plate & Holder - Push-to-Reset	\$6
APP30S-108	Slow	30mm Legend Plate & Holder - Slow	\$6
APP30S-109	Trip	30mm Legend Plate & Holder - Trip	\$6
APP30S-148	Motor Run	30mm Legend Plate & Holder - Motor Run	\$6
APP30S-149	Power Off	30mm Legend Plate & Holder - Power Off	\$6
APP30S-150	Push-to-Test	30mm Legend Plate & Holder - Push-to-Test	\$6
APP30S-151	Test	30mm Legend Plate & Holder - Test	\$6
<b>For two-position Selector Switch</b>			
APP30S-20	Forward -Reverse	30mm Legend Plate & Holder - Forward Reverse	\$6
APP30S-21	Hand - Auto	30mm Legend Plate & Holder - Hand Auto	\$6
APP30S-22	Jog - Run	30mm Legend Plate & Holder - Jog Run	\$6
APP30S-23	Manual - Auto	30mm Legend Plate & Holder - Manual Auto	\$6
APP30S-24	Off - On	30mm Legend Plate & Holder - Off On	\$6
APP30S-25	Open - Close	30mm Legend Plate & Holder - Open Close	\$6
APP30S-26	Run - Jog	30mm Legend Plate & Holder - Run Jog	\$6
APP30S-27	Start - Stop	30mm Legend Plate & Holder - Start Stop	\$6
APP30S-28	Up - Down	30mm Legend Plate & Holder - Up Down	\$6
APP30S-153	Down - Up	30mm Legend Plate & Holder - Down Up	\$6
APP30S-154	Local - Remote	30mm Legend Plate & Holder - Local Remote	\$6
APP30S-156	Reverse - Forward	30mm Legend Plate & Holder - Reverse Forward	\$6
APP30S-157	Stop - Start	30mm Legend Plate & Holder - Stop Start	\$6
APP30S-110	Auto - Hand	30mm Legend Plate & Holder - Auto Hand	\$6

# Pushbuttons and Pilot Lights

## CSW Series (30mm)

### Engraved Legend Plates

Catalog Number	Marking	Description	List Price Package with 1 unit
<b>For two-position Selector Switch</b>			
APP30S-111	Auto - Manual	30mm Legend Plate & Holder - Auto Manual	\$6
APP30S-112	Fast - Slow	30mm Legend Plate & Holder - Fast Slow	\$6
APP30S-113	High - Low	30mm Legend Plate & Holder - High Low	\$6
APP30S-114	Inch - Run	30mm Legend Plate & Holder - Inch Run	\$6
APP30S-115	Left - Right	30mm Legend Plate & Holder - Left Right	\$6
APP30S-116	On - Off	30mm Legend Plate & Holder - On Off	\$6
APP30S-119	Raise - Lower	30mm Legend Plate & Holder - Raise Lower	\$6
APP30S-120	Slow - Fast	30mm Legend Plate & Holder - Slow Fast	\$6
APP30S-121	Summer - Winter	30mm Legend Plate & Holder - Summer Winter	\$6
<b>For three-position Selector Switch</b>			
APP30S-29	Auto - Off - Hand	30mm Legend Plate & Holder - Auto Off Hand	\$6
APP30S-30	Forward - Off - Reverse	30mm Legend Plate & Holder - For Off Rev	\$6
APP30S-31	Hand - Off - Auto	30mm Legend Plate & Holder - Hand Off Aut	\$6
APP30S-32	Manual - Off - Auto	30mm Legend Plate & Holder - Man Off Auto	\$6
APP30S-33	Open - Off - Auto	30mm Legend Plate & Holder - Open Off Auto	\$6
APP30S-34	Open - Off - Close	30mm Legend Plate & Holder - Open Off Close	\$6
APP30S-35	Up - Off - Down	30mm Legend Plate & Holder - Up Off Down	\$6
APP30S-198	Low - Med - High	30mm Legend Plate & Holder - Low Med High	\$6
APP30S-199	Low - Off - High	30mm Legend Plate & Holder - Low Off High	\$6
APP30S-158	Down - Off - Up	30mm Legend Plate & Holder - Down Off Up	\$6
APP30S-159	Jog - Off - Auto	30mm Legend Plate & Holder - Jog Off Auto	\$6
APP30S-160	Raise - Off - Lower	30mm Legend Plate & Holder - Raise Off Lower	\$6
APP30S-161	Local - Off - Remote	30mm Legend Plate & Holder - Local Off Remote	\$6
APP30S-162	Forward - Auto - Rev	30mm Legend Plate & Holder - Fwd Auto Rev	\$6
APP30S-122	Auto - Manual - Off	30mm Legend Plate & Holder - Auto Manual Off	\$6
APP30S-123	High - Off - Low	30mm Legend Plate & Holder - High Off Low	\$6
APP30S-124	Off - Run - Start	30mm Legend Plate & Holder - Off Run Start	\$6
APP30S-125	Off - Start - Run	30mm Legend Plate & Holder - Off Start Run	\$6
APP30S-126	Off - 1 - 2	30mm Legend Plate & Holder - Off 1 2	\$6
APP30S-127	Slow - Off - Fast	30mm Legend Plate & Holder - Slow Off Fast	\$6
APP30S-128	Summer - Off - Winter	30mm Legend Plate & Holder - Summer Off Winter	\$6
APP30S-129	1 - Off - 2	30mm Legend Plate & Holder - 1 Off 2	\$6
APP30S-130	1 - 2 - 3	30mm Legend Plate & Holder - 1 2 3	\$6
<b>For Push/Pull units</b>			
APP30S-36	On - Off	30mm Legend Plate & Holder - On / Off	\$6
APP30S-37	Open - Close	30mm Legend Plate & Holder - Open / Close	\$6
APP30S-38	Up - Down	30mm Legend Plate & Holder - Up / Down	\$6
APP30S-152	Pull Start - Push Stop	30mm Legend Plate & Holder - Pull Start / Push Stop	\$6
APP30S-155	Push to Stop - Pull to Start	30mm Legend Plate & Holder - Push to Stop / Pull to Start	\$6
APP30S-117	Push Off - Pull On	30mm Legend Plate & Holder - Push Off / Pull On	\$6
APP30S-118	Push On - Push Off	30mm Legend Plate & Holder - Push On / Push Off	\$6
<b>For Potentiometers</b>			
APP30S-P00	0 - 100	30mm Legend Plate & Holder - (Blank 0 - 100)	\$6
APP30S-P01	0 - 10	30mm Legend Plate & Holder - (Blank 1 - 10)	\$6
APP30S-P02	Speed 0 - 10	30mm Legend Plate & Holder - (Speed 1 - 10)	\$6
APP30S-P03	Speed 0 - 100	30mm Legend Plate & Holder - (Speed 1 - 100)	\$6

General Information

Circuit Protection

Disconnect Switches

Motor Protectors

Contactors

Overloads

Enclosed Starters

Relays

Pushbuttons and Pilot Lights

Terminal Blocks

Power Factor Correction

Appendix A

Appendix B

### Technical Data

#### ELECTRICAL RATINGS - 30MM INDUSTRIAL PILOT DEVICES

Lamp	Industry Number	Rated Volts	Lumens (MSCD)	Design Life (Hrs.)	Current Draw (mA)	Lamp Type	Shock & Vibration	Leakage Protection
BIDL6	**	6V	Varies w/ Color	100,000	50	LED	Excellent	14 mA
BIDL12	**	12V	Varies w/ Color	100,000	<20	LED	Excellent	4 mA
BIDL24	**	24V	2000 mcd	100,000	<20	LED	Excellent	4 mA
BIDL130	**	120/130V	Typical	100,000	<10	LED	Excellent	2 mA

\*Specify lamp color when ordering.

#### Dielectric Strength (Terminal to Ground) 2200V for 1 Minute

Standard Contacts	Utilization Category	IEC	UL	Make Rating	Break Rating	lth-Thermal Current
		AC	AC-15	A600	720VA	720VA
		DC	DC-13	P300	138VA	138VA

Note: For AC voltage below 72V AC the max. allowed switching current is 10A = lth. For DC voltages below 28V DC the max. allowed switching current is 5A = lth.

For switching applications below 24V/40mA - Hermetic REED contacts are recommended. Hermetic Reeds are also excellent in environments containing chemical vapors, oxidizing agents, and explosive gases. Please refer to the HAZARDOUS section of the 30mm devices for more information.

Environmental Ratings	Materials	Materials
Operating Temperature -40 to +131° F ( -40 to +55° C)	<b>Thermoplastic Polyester and Polyester Blends (UV Stabilized for outdoor use)</b>	<b>Pushbuttons (Operator Only)</b>
Storage Temperature -40 to +185° F ( -40 to +85° C)	Operator Housings	Momentary 1.3 lbs. [5.8N]
Operating environments below freezing temperatures are assumed to be absent of freezing liquids or pollutants.	Operator Caps and Handles - Non-illuminated (Glass Reinforced Grades)	Illuminated Momentary 2.8 lbs. [12.4N]
	Mounting Rings and Nuts	Maintained 4 to 6 lbs [17.9~26.7 N]
	Thrust Washer	Illuminated Maintained 4.6 lbs. [20.5 N]
	Trim Washer	<b>Reset Push Button</b> 1.5 lbs. [6.7 N]
<b>Terminal &amp; Wiring Consideration</b>	<b>High Impact Polycarbonate (UV Stabilized for outdoor use)</b>	<b>Selector Switches</b>
Wire - AWG 22-12 CU (Copper Only - Solid & Stranded [.5-4 mm <sup>2</sup> ] One or Two wires permitted per termination	Pilot Light Lens	Maintained 1.7 in-lbs [19 Nm]
Recommended Tightening Torque 7 lb-in (+3.0/-0.0 lb-in - [.8 Nm])	Transparent Pushbutton and Mushroom Caps	Momentary 1.7 in-lbs [19 Nm]
	<b>Custom Polymers</b>	Key Operated 1.7 in-lbs [19 Nm]
	Certain CAM and Bearing parts are Teflon, Silicone, & Moly-Disulfide Impregnated for improved wearability	<b>Cable Pull</b>
<b>Mechanical Design Life Cycles</b>	Fluorosilicone and Thermoplastic Neoprene Boot Accessories	Standard 4 to 6 lbs [17.9~26.7 N]
Push Buttons	<b>Seals</b>	Heavy Duty 13 lbs. [57.8 N]
Momentary 5,000,000	Neoprene Gaskets	<b>Push-Twist Release</b> 4.7 lbs [20.9 N]
Maintained 250,000	Thermoplastic - Molded Neoprene and alloy derivatives	<b>Potentiometer</b>
Selector Switches 500,000	BUNA N - Rubber - Teflon Coated	2 Watt "J" Series 3-12 in-oz [11 Nm Max.] (300° Rotation)
All Other Devices 250,000	Thermoplastic - Elastomer Molded Seals	<b>Standard Contact Blocks</b> 1 lb. [4.45 N]
Standard Contact Blocks 10,000,000	Fluorosilicone - Boots	<b>Indicating Lights</b> Refer to the appropriate Lamp Data
Indicating Lights - Refer to the appropriate Lamp Data	<b>Metal: Brass &amp; Stainless Steel</b>	<b>Multi-Voltage Light</b> 20-140 VAC/VDC (Burden .65W max.)
	Push Pull Bushings	<b>Transformer</b> 2 VA
	Internal tubes for Maintained Devices	
	Detents for Maintained Devices	
	Springs (Stainless Steel throughout)	
	<b>Aluminum</b>	
	Optional Mounting Nut	

# Pushbuttons and Pilot Lights

## CSW Series (30mm)

### Momentary & Maintained Non-Illuminated Push Buttons

Fully-assembled operators come standard with one 3/16" (4.8mm) and three 1/16" (1.6mm) gaskets.

**Non-Illuminated Operator**  
(shown with Flush Cap)

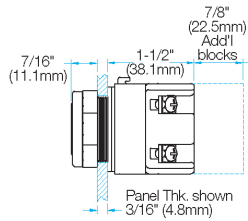

**Momentary Flush Cap**

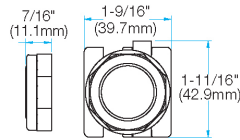

**Momentary Guarded Flush Cap**

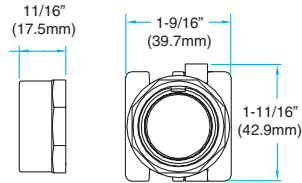

**Momentary Extended Cap**

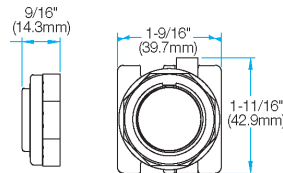

**Momentary Guarded Extended Cap**

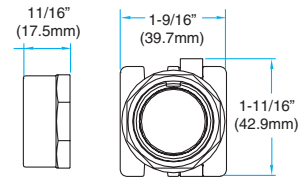

**Momentary Standard Rubber Boot**

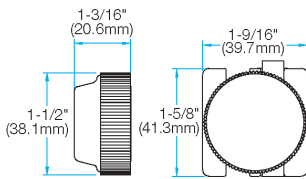

**Momentary 1-1/2" (38mm) Mushroom Cap**

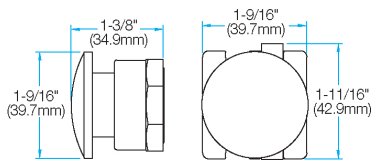

**Momentary 2-1/4" (57.2mm) Jumbo Mushroom Cap**

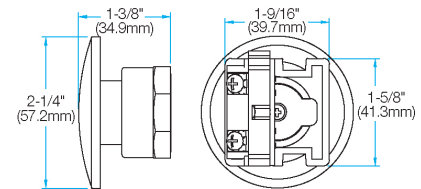

**Momentary Fluorosilicone Rubber Boot**

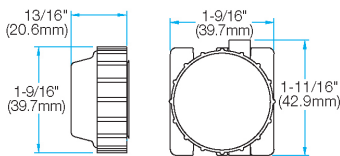

**Momentary 1-1/2" (38mm) Shrouded Mushroom Cap**

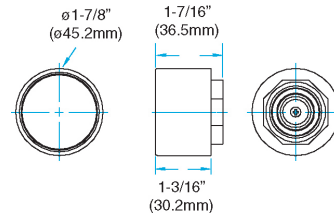

**Momentary 2-1/4" (57.2mm) Shrouded Jumbo Mushroom Cap**

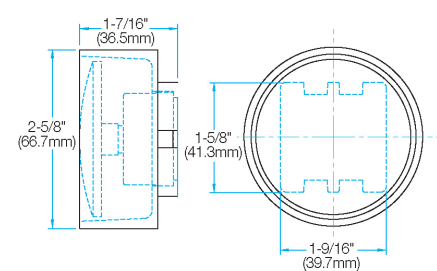

**2-Position Push-Pull Maintained 1-1/2" (38mm) Mushroom Cap**

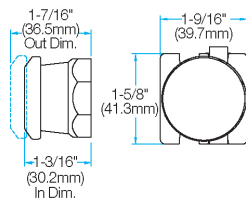

**2-Position Push-Pull Maintained 2-1/4" (57.2mm) Jumbo Mushroom Cap**

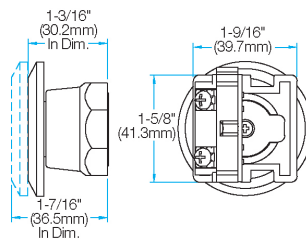

**2-Position Push-Twist Maintained 1-1/2" (38mm) Mushroom Cap**

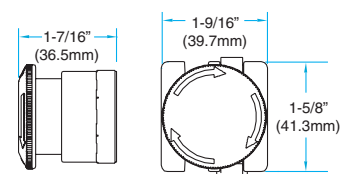

General Information

Circuit Protection

Disconnect Switches

Motor Protectors

Contactors

Overloads

Enclosed Starters

Relays

Pushbuttons and Pilot Lights

Terminal Blocks

Power Factor Correction

Appendix A

Appendix B

### Momentary Illuminated Push Buttons

Fully-assembled operators come standard with one 3/16" (4.8mm) and three 1/16" (1.6mm) gaskets.

#### Illuminated Full Voltage, Resistor and Dual-Input Operators

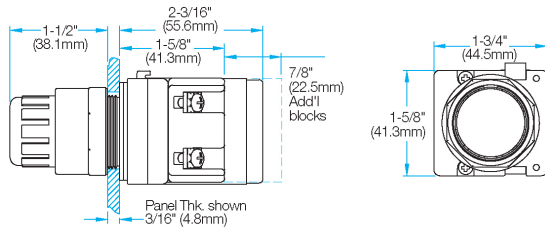

#### Illuminated Full Voltage Operators

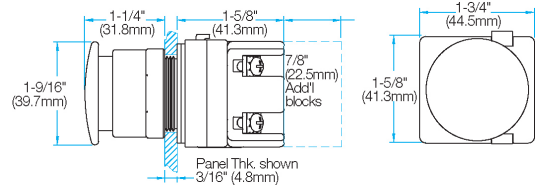

#### Illuminated Shrouded Mushroom Lens

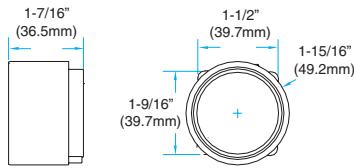

#### Illuminated Guarded Lens

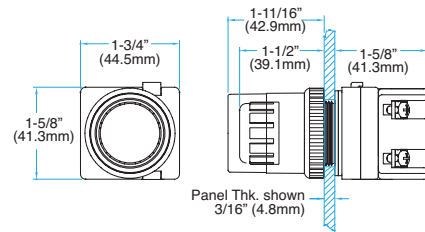

### 2 & 3 Position Push-Pull Maintained Illuminated Push Buttons

Fully-assembled operators come standard with one 3/16" (4.8mm) and three 1/16" (1.6mm) gaskets.

#### Illuminated Full Voltage Operator

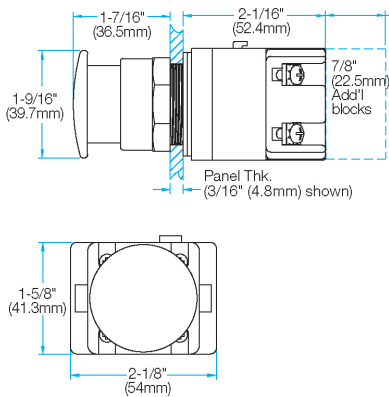

### Reset Push Button

Fully-assembled operators come standard with one 3/16" (4.8mm) and three 1/16" (1.6mm) gaskets.

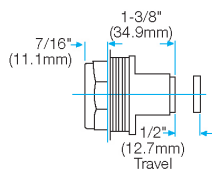

### Alternate Action Block

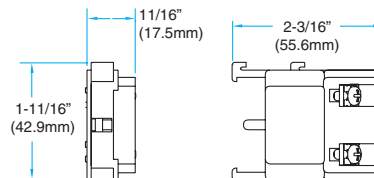

General Information

Circuit Protection

Disconnect Switches

Motor Protectors

Contactors

Overloads

Enclosed Starters

Relays

Pushbuttons and Pilot Lights

Terminal Blocks

Power Factor Correction

Appendix A

Appendix B



# Pushbuttons and Pilot Lights

## CSW Series (30mm)

### Wobble stick

Fully-assembled operators come standard with one 3/16" (4.8mm) and three 1/16" (1.6mm) gaskets.

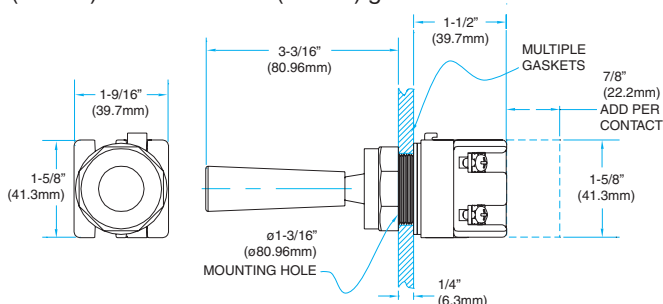

### Potentiometer with & without Terminal Block

Fully-assembled operators come standard with one 3/16" (4.8mm) and three 1/16" (1.6mm) gaskets.

#### Potentiometer Operator (shown without Terminal Block)

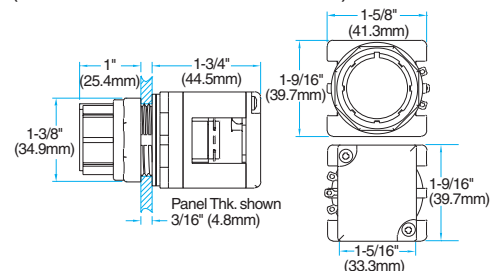

#### Potentiometer Operator (shown with Terminal Block)

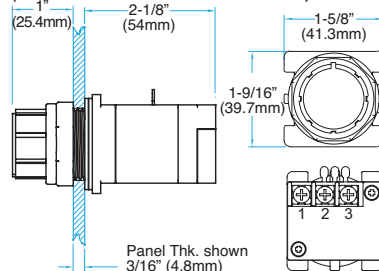

### Contact Blocks

#### Contact Block

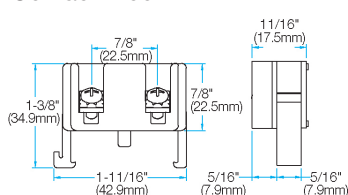

#### Contact Block (shown with IP20 Terminal Guard)

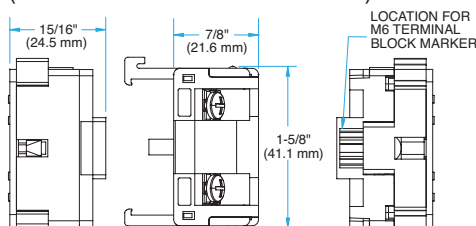

### Cable Pull Operators

Fully-assembled operators come standard with one 3/16" (4.8mm) and three 1/16" (1.6mm) gaskets.

#### Push-Pull Maintained Cable Pull Operator

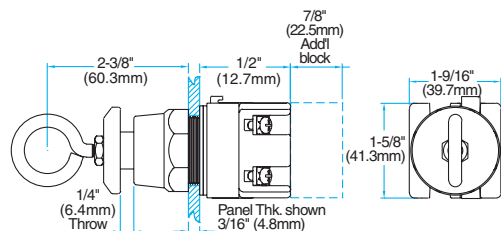

*Momentary and Heavy Duty Cable Pull Operators*

*Momentary Booted Cable Pull Operator*

General Information

Circuit Protection

Disconnect Switches

Motor Protectors

Contactors

Overloads

Enclosed Starters

Relays

Pushbuttons and Pilot Lights

Terminal Blocks

Power Factor Correction

Appendix A

Appendix B

### Maintained flush & extended push button caps

Fully-assembled operators come standard with one 3/16" (4.8mm) and three 1/16" (1.6mm) gaskets.

Maintained Flush Push Button Cap  
(shown with an operator and contact block)

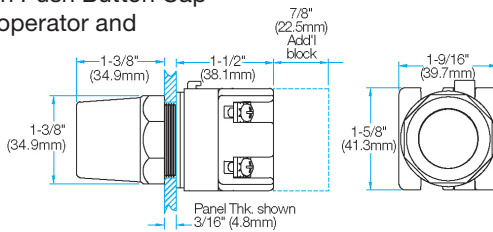

Maintained Extended Push Button Cap

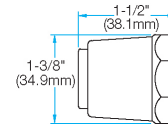

### Pilot Lights

Fully-assembled operators come standard with one 3/16" (4.8mm) and two 1/16" (1.6mm) gaskets.

Full Voltage Pilot Light Operator

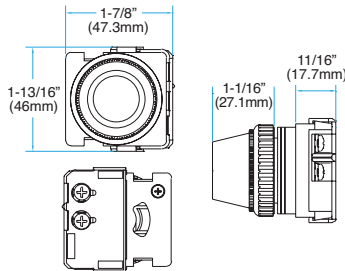

Resistor Pilot Light Operators

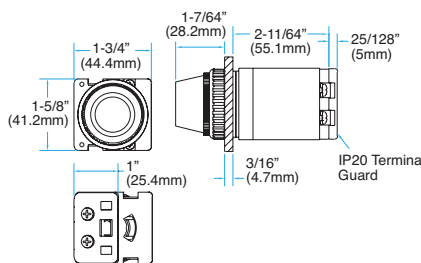

Dual Input Pilot Light Operator

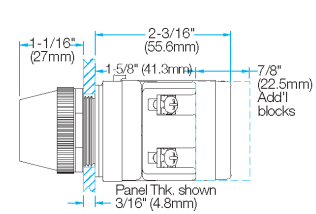

### Multi-Voltage Pilot Light

Fully-assembled operators come standard with four 1/16" (1.6mm) gaskets.

Multi-Voltage

Pilot

Light

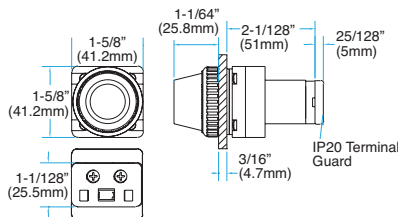

### Drilling

CSW30 Panel Cutout

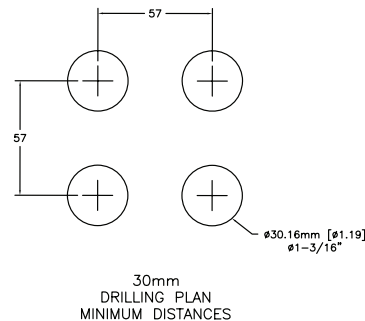

# Pushbuttons and Pilot Lights

## CSW Series (30mm)

### Push-To-Test Pilot Lights

Fully-assembled operators come standard with one 3/16" (4.8mm) and three 1/16" (1.6mm) gaskets.

#### Full Voltage, Resistor Push-To-Test Operators

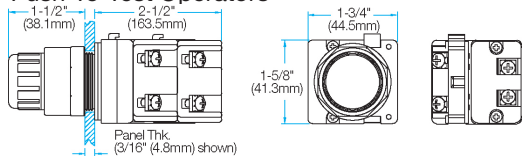

#### Full Voltage, Resistor Push-To-Test Operators

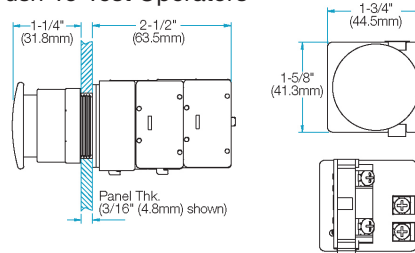

#### Guarded Lens

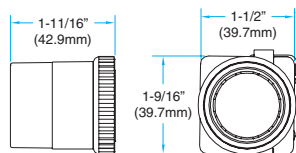

#### Shrouded Mushrooms Lens

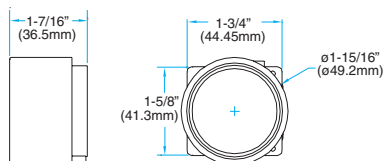

### Selector switches

Fully-assembled operators come standard with one 3/16" (4.8mm) and three 1/16" (1.6mm) gaskets.

#### Selector Switch Operator (shown with standard handle)

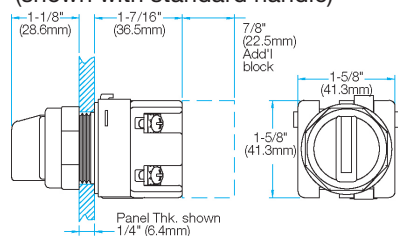

#### Selector Switch Lever Handle

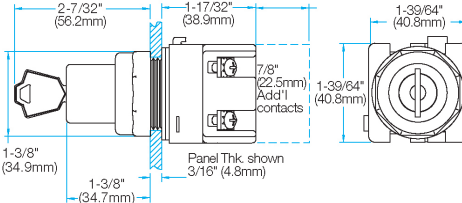
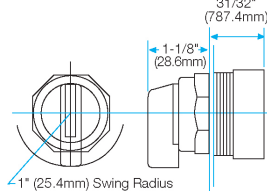

### lock-off attachment

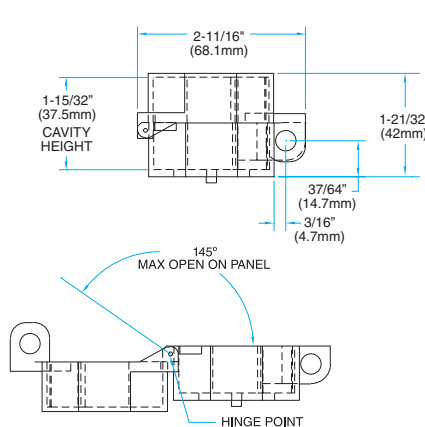
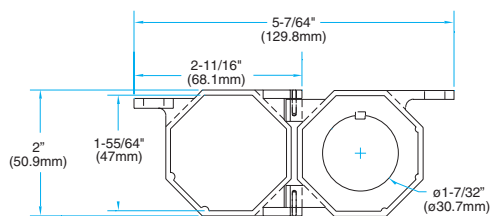

## CSW30H Series (30mm) Hazardous Duty General Standards

WEG hazardous duty series CSW30H also offers a wide selection of operators and pilot devices for hazardous duty applications (Class 1, Division 2 and Zone 2). This series offers a wide selection of hermetically sealed reed and factory sealed contact blocks for superior corrosion resistance.

- NEMA 4, IP65 Rated<sup>1</sup>
- Fits 1-13/64 (30.5mm) hole without notch required
- Contact blocks snap-in (fast & easy assembly)
- Up to 8 contact blocks for non-illuminated operators and up to 4 contact blocks for illuminated operators
- LED lamps with built-in leakage protection
- Same simple part numbering system as 22mm series

WEG Hazardous duty Pilots Devices are specially engineered for Class 1, Division 2 and Zone 2.

Wide selection of hermetically sealed reed and factory sealed contact block.

An all-polyester construction with nickel-plated or stainless steel metal parts for superior corrosion resistance.

Logic Reeds are hermetically sealed, Providing needed dependability for harsh environments.

Logic Reeds provide great operation for low power level ( resistive loads only ), especially PLC inputs.

### Added Security - Optional Features

Rubber Boots add an additional layer of protection from corrosive chemicals left behind from hands on operations or washdown environments.

### Added Security - Standard Features

All Hazardous duty Push Buttons comes standard with a screw tightening mounting bracket to ensure the contact blocks remain tight to the operator

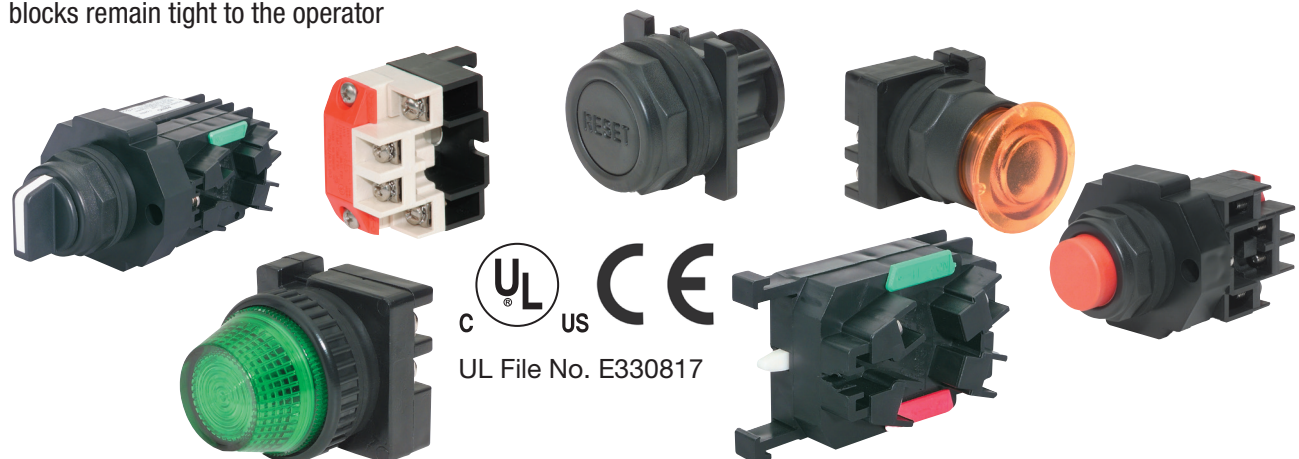

- General Information
- Circuit Protection
- Disconnect Switches
- Motor Protectors
- Contactors
- Overloads
- Enclosed Starters
- Relays
- Pushbuttons and Pilot Lights**
- Terminal Blocks
- Power Factor Correction
- Appendix A
- Appendix B

# Pushbuttons and Pilot Lights

## CSW30H Series (30mm) Hazardous Duty

### Pushbuttons

#### Types

- BF - Flush
- BS - Extended
- BC - Mushroom
- BGA - Recessed
- BGAI - Illuminated Recessed
- BSI - Illuminated Extended
- BCI - Illuminated Mushroom

MULTIPLIER SYMBOL FOR CSW30H SERIES - Z55

CSW30H-

Voltage (see Voltage Code)  
Color (see Color Code)

NON-ILLUMINATED FLUSH	NON-ILLUMINATED (Extended)	NON-ILLUMINATED MUSHROOM (40mm HEAD)	NON-ILLUMINATED RECESSED
<p>CSW30H - _</p> <ul style="list-style-type: none"> <li>○ BF0</li> <li>● BF1</li> <li>● BF2</li> <li>● BF3</li> <li>● BF4</li> <li>● BF5</li> </ul>  <p>LIST PRICE \$31</p>	<p>CSW30H - _</p> <ul style="list-style-type: none"> <li>○ BS0</li> <li>● BS1</li> <li>● BS2</li> <li>● BS3</li> <li>● BS4</li> <li>● BS5</li> </ul>  <p>LIST PRICE \$31</p>	<p>CSW30H - _</p> <ul style="list-style-type: none"> <li>● BC1</li> <li>● BC2</li> <li>● BC5</li> </ul>  <p>LIST PRICE \$42</p>	<p>CSW30H - _</p> <ul style="list-style-type: none"> <li>○ BGA0</li> <li>● BGA1</li> <li>● BGA2</li> <li>● BGA3</li> <li>● BGA4</li> <li>● BGA5</li> </ul>  <p>LIST PRICE \$37</p>
<p>* Illuminated operators are supplied with LED block. To complete selection, replace “**” with desired voltage: E26 (24Vac/Vdc), D61 (120Vac/Vdc) or D66 (240Vac/Vdc).</p>			
ILLUMINATED EXTENDED	ILLUMINATED MUSHROOM (40mm HEAD)	ILLUMINATED RECESSED	
<p>CSW30H - _ *</p> <ul style="list-style-type: none"> <li>○ BSI0</li> <li>● BSI1</li> <li>● BSI2</li> <li>● BSI3</li> <li>● BSI4</li> </ul>  <p>LIST PRICE \$110</p>	<p>CSW30H - _ *</p> <ul style="list-style-type: none"> <li>○ BCI0</li> <li>● BCI1</li> <li>● BCI2</li> <li>● BCI3</li> <li>● BCI4</li> </ul>  <p>LIST PRICE \$120</p>	<p>CSW30H - _ *</p> <ul style="list-style-type: none"> <li>○ BGAI0</li> <li>● BGAI1</li> <li>● BGAI2</li> <li>● BGAI3</li> <li>● BGAI4</li> </ul>  <p>LIST PRICE \$115</p>	

Note: Contact blocks ordered separately. See page 326.

### Emergency-Stop Pushbuttons

CSW30H-

- Types
- G - Twist release
  - P - Pull release

CSW30H-

Voltage (see Voltage Code)  
Color (see Color Code)

E-STOP - TWIST RELEASE	E-STOP - PUSH PULL	PILOT LIGHTS
<ul style="list-style-type: none"> <li>● CSW30H-BEG</li> <li>● CSW30H-BEG2</li> </ul>  <p>LIST PRICE \$86</p>	<ul style="list-style-type: none"> <li>● CSW30H-BEP</li> <li>● CSW30H-BEP2</li> </ul>  <p>LIST PRICE \$80</p>	<p>CSW30H - _ *</p> <ul style="list-style-type: none"> <li>○ SD0</li> <li>● SD1</li> <li>● SD2</li> <li>● SD3</li> <li>● SD4</li> </ul>  <p>LIST PRICE \$107</p>

#### Code Chart

Color	Clear/White	Red	Green	Yellow	Blue	Black
Code	0	1	2	3	4	5
Symbol	○	●	●	●	●	●

LED Block Voltage	
E26	24Vac/Vdc
D61	120Vac/Vdc
D66	240Vac/Vdc

Note: Contact blocks ordered separately. See page 326

### Selector Switches



Types  
**CK** - Knob  
**CA** - Lever

### CSW30H-

No. of Positions  
**2** - Two positions  
**3** - Three positions

Angle  
**45 - 45°**  
**90 - 90°**

Handle  
**F** - Maintained  
**R** - Spring return  
**RE** - Spring return from left  
**RD** - Spring return from right

KNOB	LEVER	POSITION	DIAGRAM
  <b>LIST PRICE</b> Maintained <b>\$44</b> Spring Return <b>\$62.00</b>	  <b>LIST PRICE</b> Maintained <b>\$44</b> Spring Return <b>\$62</b>		
CSW30H-CK2F90	CSW30H-CA2F90	I  II	1
CSW30H-CK2R90	CSW30H-CA2R90	I  II	1
CSW30H-CK3F45	CSW30H-CA3F45	I  II	2 & 3
CSW30H-CK3R45	CSW30H-CA3R45	I  II	2 & 3
CSW30H-CK3RE45	CSW30H-CA3RE45	I  II	2 & 3
CSW30H-CK3RD45	CSW30H-CA3RD45	I  II	2 & 3

Catalog Number	List Price	Multiplier
<b>CSW30-FCR</b>	<b>\$15</b>	Z5
<b>CSW30-ECR</b>	<b>\$15</b>	
<b>CSW30-PLCR</b>	<b>\$15</b>	

Note: Contact blocks ordered separately. See page 326

**DIAGRAM 1 - Hermetically & Factory Sealed Block**

HANDLE POSITION		Auxiliary Contact	Mounting Position
I	II		
0	X	NO	Either
X	0	NC	Either
0	X	NO & NC	Either
X	0		

X = CLOSED  
 0 = OPEN

**DIAGRAM 2 - Factory Sealed Block**

HANDLE POSITION			Auxiliary Contact	Mounting Position
I	0	II		
X	0	0	NO & NC	Left
0	X	0		
0	0	X	NO & NC	Right
0	X	0		

**DIAGRAM 3 - Hermetically Sealed Block**

HANDLE POSITION			Auxiliary Contact	Mounting Position
I	0	II		
X	0	0	NO	Left
0	0	X	NO	Right
0	X	X	NC	Left
X	X	0	NC	Right
X	0	X	2NO	wired in parallel
0	X	0	2NC	wired in series
X	0	X	early make	Either
0	X	X	late break	Left
X	X	0	late break	Right

# Pushbuttons and Pilot Lights

CSW30H Series (30mm) Hazardous Duty

## Factory Sealed / Hermetically Sealed Contact Blocks

General Information

Circuit Protection

Disconnect Switches

Motor Protectors

Contactors

Overloads

Enclosed Starters

Relays

Pushbuttons and Pilot Lights

Terminal Blocks

Power Factor Correction

Appendix A

Appendix B

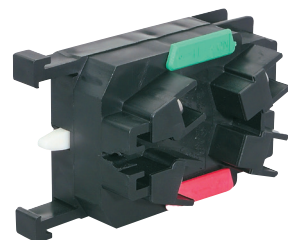
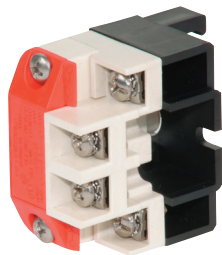

Auxiliary Contact Blocks - Factory Sealed (720VA) Product Description	Catalog Number	List Price	Multiplier
Linear devices - 1NO & 1NC	<a href="#">BC11FS-CSW30H</a>	\$120	Z55
For rotary devices only - 1NO & 1NC	<a href="#">BC11FSR-CSW30H</a>		

Auxiliary Contact Blocks - Hermetically Sealed (360VA inductive) Product Description			
Power reed - 1NO	<a href="#">BC10PR-CSW30H</a>	\$95	Z55
Power reed - 1NC	<a href="#">BC01PR-CSW30H</a>		
Power reed - 2NO	<a href="#">BC20PR-CSW30H</a>	\$150	
Power reed - 2NC	<a href="#">BC02PR-CSW30H</a>		
Power reed - 1NO & 1NC	<a href="#">BC11PR-CSW30H</a>		

Auxiliary Contact Blocks - Hermetically Sealed (180VA inductive) Product Description			
Mid-power reed - 1NO	<a href="#">BC10MP-CSW30H</a>	\$75	Z55
Mid-power reed - 1NC	<a href="#">BC01MP-CSW30H</a>		
Mid-power reed - 2NO	<a href="#">BC20MP-CSW30H</a>	\$130	
Mid-power reed - 2NC	<a href="#">BC02MP-CSW30H</a>		
Mid-power reed - 1NO & 1NC	<a href="#">BC11MP-CSW30H</a>		

Auxiliary Contact Blocks - Hermetically Sealed (40VA inductive / 100W resistive) Product Description			
Mid-logic reed - 1NO	<a href="#">BC10ML-CSW30H</a>	\$45	Z55
Mid-logic reed - 1NC	<a href="#">BC01ML-CSW30H</a>		
Mid-logic reed - 2NO	<a href="#">BC20ML-CSW30H</a>	\$70	
Mid-logic reed - 2NC	<a href="#">BC02ML-CSW30H</a>		
Mid-logic reed - 1NO & 1NC	<a href="#">BC11ML-CSW30H</a>		

Auxiliary Contact Blocks - Hermetically Sealed (40W resistive) Product Description			
Logic reed - 1NO	<a href="#">BC10LR-CSW30H</a>	\$28	Z55
Logic reed - 1NC	<a href="#">BC01LR-CSW30H</a>		

### Technical Data

**FACTORY SEALED:** Contact Blocks are Certified as "Explosion Proof". Devices employing this method of protection are designed so that all electrical parts are enclosed in a switch housing that is capable of withstanding, without damage, an explosion of a specified gas or vapor/air mixture which may occur during the operation of the switch. Further, the explosion internal to the switch body is controlled so that the hot gases are extinguished and cooled before they are allowed to escape to the surrounding atmosphere.

**HERMETICALLY SEALED:** Contact Blocks are Certified as "Non-Incendive". Devices employing this method of protection are designed so that all electrical parts are a bonded part of the switch housing that forms an arcing chamber that is evacuated of all oxygen, filled with an inert gas, and then sealed to prohibit the exchange of gases with the surrounding environment. These devices are incapable of igniting the surrounding gases or vapor/air mixtures under normal operation. Devices of this type are suitable for use in Div. 2/ Zone 2 applications. Hermetically Sealed contact blocks are also extremely useful for switching low energy circuits or circuits applied in atmospheres containing oxidizing agents and pollutants that might effect the performance of silver switching and metal contact elements. Hermetically Sealed Switch performance is consistent and repeatable in almost any environment.

**DIELECTRIC STRENGTH (MECHANICAL CONTACTS)** 2200V for 1 Minute

Factory Sealed Contact Block					
Class I Div. 2 Gr. B,C, & D / Zone 2 Gr. IIB +H2					
	Utilization Category		Make Rating	Break Rating	lth-Thermal Current
	IEC	UL			
AC	AC-15	A600	7200VA	720VA	10A
DC	DC-13	Q300	69VA	69VA	2.5A

NOTE: For AC voltage below 72V AC the max. allowed switching current is 10A = lth.  
For DC voltages below 28V DC the max. allowed switching current is 2.5A = lth.  
For switching applications below 24V/40mA, Hermetic REED contacts are recommended.

Hermetically Sealed Mid-Power Reed Contact Block					
Class I Div. 2 Gr. A, B, C, & D/Zone 2 Gr. IIC					
	Utilization Category		Make Rating	Break Rating	lth-Thermal Current
	IEC	UL			
AC	AC-15	C300	1800VA	180VA	2.5A
DC	DC-13	Q150	69VA	69VA	2.5A

NOTE: For AC voltage below 72VAC the max. allowed switching current is 2.5A = lth.  
For DC voltages below 28VDC the max. allowed switching current is 2.5A = lth.  
Suitable for switching DRY Circuits and Low Energy Circuits (Less than 24V-40mA).

Hermetically Sealed Power Reed Contact Block					
Class I Div. 2 Gr. A, B, C, & D/Zone 2 Gr. IIC					
	Utilization Category		Make Rating	Break Rating	lth-Thermal Current
	IEC	UL			
AC	AC-15	B300	3600VA	360VA	5A
	AC-15	C600	1800VA	180V	2.5A
DC	DC-13	Q300	69VA	69VA	2.5A

NOTE: For AC voltage below 72V AC the max. allowed switching current is 5A = lth.  
For DC voltages below 28V DC the max. allowed switching current is 2.5A = lth.  
Suitable for switching DRY Circuits and Low Energy Circuits (Less than 24V-40mA).

Hermetically Sealed logic reed Contact Block					
Class I Div. 2 Gr. A, B, C, & D/Zone 2 Gr. IIC					
	Utilization Category		Inductive	Resistive	lth-Thermal Current
	IEC	UL			
AC		220V Max.	N/A	40 Watt	2A

Suitable for switching DRY Circuits and Low Energy Circuits (Less than 24V-40mA).

Hermetically Sealed mid-logic reed Contact Block					
Class I Div. 2 Gr. A, B, C, & D/Zone 2 Gr. IIC					
	Utilization Category		Inductive	Resistive	lth-Thermal Current
	IEC	UL			
AC	AC-12	250V Max.	40VA	100 Watt	3A

Suitable for switching DRY Circuits and Low Energy Circuits (Less than 24V-40mA).

Indicating Lights	
Light Unit	T-Code
FV Incandescent Lights	T4A
FV LED Lights	T6 [No marking required]
Resistor Lights	T3C
Light Unit	T-Code
Resistor LED Lights	T6
Transformer Lights Incd. & LED	T4A
Multi-Voltage 20V-240V LED Light	T4A

Materials	
<b>Thermoplastic Polyester and Polyester Blends (UV Stabilized for outdoor use)</b>	<b>Seals</b>
Operator Housings	Neoprene Gaskets
Operator Caps and Handles –	Thermoplastic – Molded Neoprene and alloy derivatives
Non-Illuminated (Glass Reinforced Grades)	BUNA N – Rubber – Teflon Coated
Mounting Rings and Nuts	Thermoplastic – Elastomer Molded Seals
Thrust Washer	Fluorosilicone – Boots
Trim Washer	<b>Metal: Stainless Steel</b>
<b>High Impact Polycarbonate (UV Stabilized for outdoor use)</b>	Push Pull Bushings
Pilot Light Lens	Internal tubes for Maintained Devices
Transparent PB and Mushroom Caps	Detents for Maintained Devices
<b>Custom Polymers</b>	Stainless Steel Springs and Screws throughout
Certain CAM and Bearing parts are Teflon, Silicone, & Moly-Disulfide Impregnated for improved wearability	<b>Aluminum</b>
Fluorosilicone and Thermoplastic	Optional Mounting Nut
Neoprene Boot Accessories	

Environmental Ratings	
Type 1, 2, 3, 3R, 4/4X, 12, 13, and IP65	
Operating Temperature	
-40 to +131° F ( -40 to +55° C )	
Storage Temperature	
-40 to +185° F ( -40 to +85° C )	
Operating environments below freezing temperatures are assumed to be absent of freezing liquids or pollutants.	

Terminal & Wiring Consideration	
Wire- AWG 22-12 CU	
(Copper Only – Solid & Stranded) [ .5 ~ 4 mm2 ]	
One or Two wires permitted per termination	
Recommended Tightening Torque	
7 lb-in ( +3.0/-0.0 lb-in ) — [ .8 Nm ]	



# Pushbuttons and Pilot Lights

## CSW30H Series (30mm) Hazardous Duty

### Momentary Non-Illuminated H-Line Push Buttons

Fully-assembled operators come standard with one 3/16" (4.8mm) and three 1/16" (1.6mm) gaskets.

Non-Illuminated Operator  
(shown with Flush Cap & Factory Sealed Contact Block)

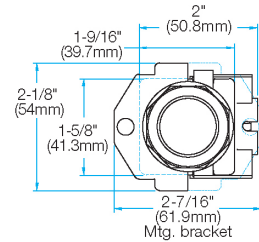
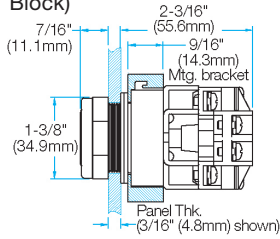

Momentary Extended Cap

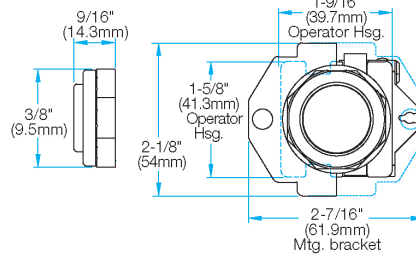

Momentary 1-1/2" (38mm)  
Mushroom Cap

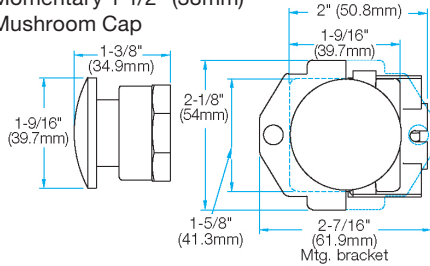

Momentary Guarded  
Flush Cap

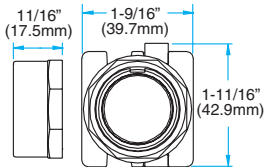

Momentary Guarded  
Extended Cap

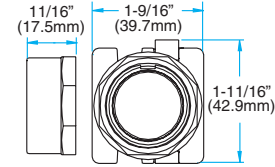

Momentary 2-1/4" (57.2mm)  
Jumbo Mushroom Cap

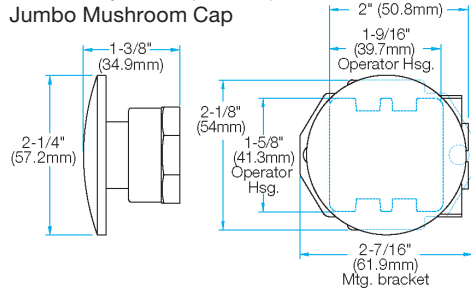

Momentary 1-1/2" (38mm)  
Shrouded Mushroom Cap

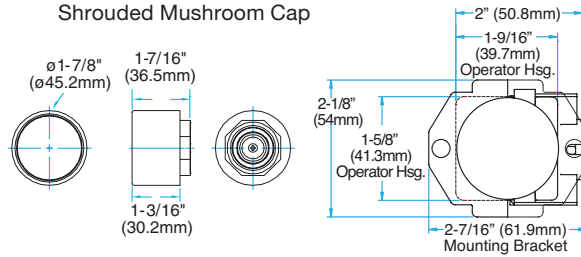

Momentary Fluorosilicone  
Rubber Boot

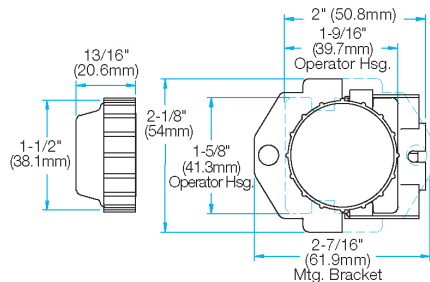

Non-Illuminated Push Button  
Mounting Bracket

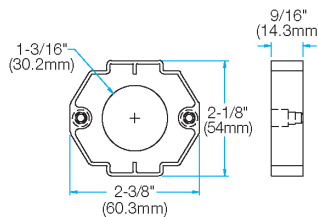

Momentary 2-1/4" (57.2mm)  
Shrouded Jumbo Mushroom Cap

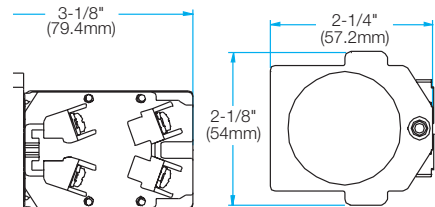

I Thk.  
" (4.8mm) shown

### Maintained non-Illuminated H-Line Push Buttons

Fully-assembled operators come standard with one 3/16" (4.8mm) and three 1/16" (1.6mm) gaskets.

#### 2-Position Push-Pull Maintained 1-1/2" (38mm) Mushroom Cap

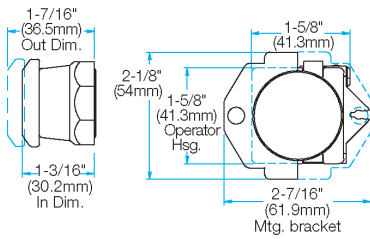

#### 2-Position Push-Pull Maintained Operator (shown with 2-1/4" (57.2mm) Jumbo Mushroom Cap)

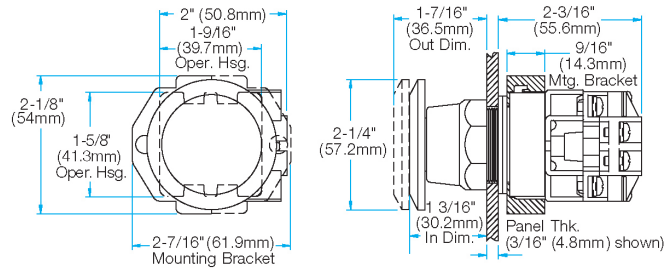

### Momentary Illuminated H-Line Push Buttons

Fully-assembled operators come standard with one 3/16" (4.8mm) and three 1/16" (1.6mm) gaskets.

#### Illuminated Full Voltage Operator

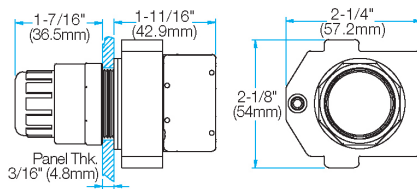

#### Illuminated Transformer, Resistor and Dual Input Operators

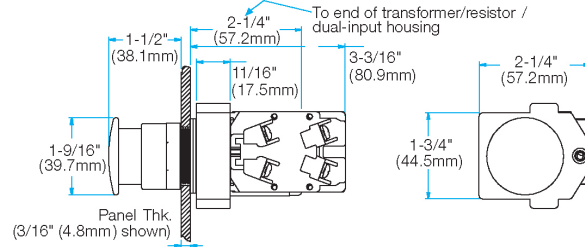

#### Illuminated Push Button Mounting Bracket

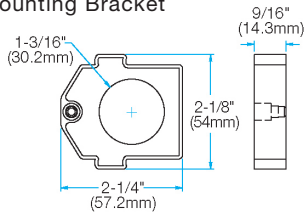

#### Illuminated Shrouded Mushroom Lens

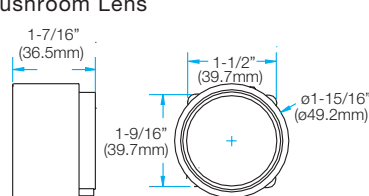

#### Illuminated Guarded Lens

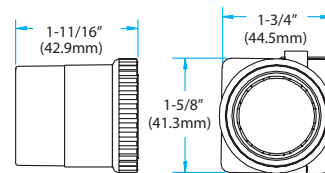

### 2-Position Push-Pull Maintained Illuminated H-Line Push Buttons

Fully-assembled operators come standard with one 3/16" (4.8mm) and three 1/16" (1.6mm) gaskets.

#### Illuminated Full Voltage Operator

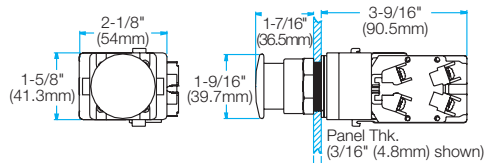

#### Illuminated Transformer and Resistor Operators

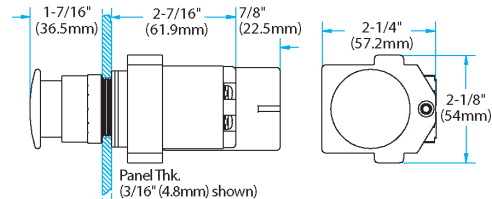

# Pushbuttons and Pilot Lights

## CSW30H Series (30mm) Hazardous Duty

### H-Line Pilot Lights

Fully-assembled operators come standard with one 3/16" (4.8mm) and two 1/16" (1.6mm) gaskets.

Full Voltage Pilot Light Operator

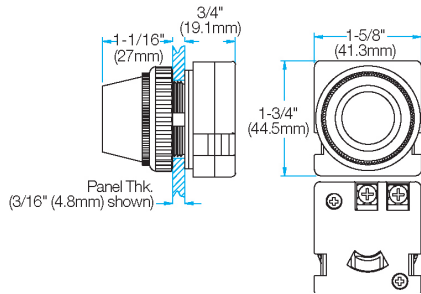

Transformer & Resistor Pilot Light Operators

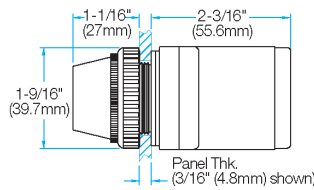

Dual Input Pilot Light Operator

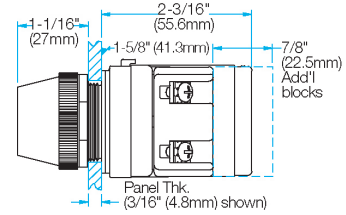

### Push-To-Test H-Line Pilot Lights

Fully-assembled operators come standard with one 3/16" (4.8mm) and three 1/16" (1.6mm) gaskets.

Full Voltage Push-To-Test Operator

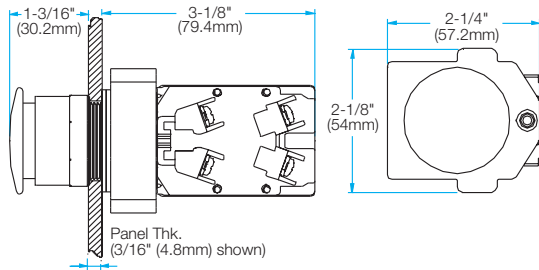

Transformer & Resistor Push-To-Test Operators

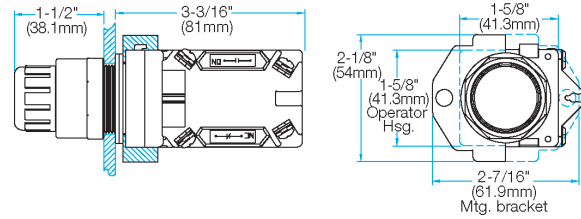

Guarded Lens

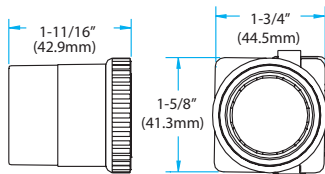

Shrouded Mushroom Lens

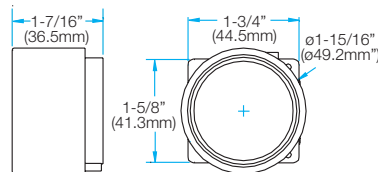

Illuminated Push-To-Test Mounting Bracket

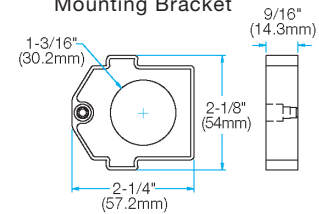

### Multi-Voltage H-Line Pilot Light

Fully-assembled operators come standard with four 1/16" (1.6mm) gaskets.

Multi-Voltage Pilot Light

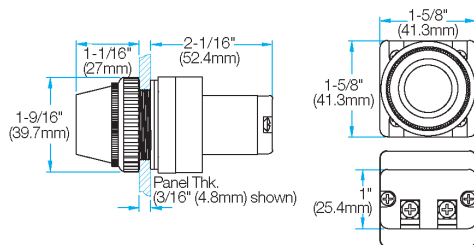

## H-line Selector Switches

Fully-assembled operators come standard with one 3/16" (4.8mm) and three 1/16" (1.6mm) gaskets.

Selector Switch Operator  
(shown with standard handle)

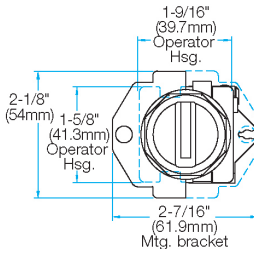
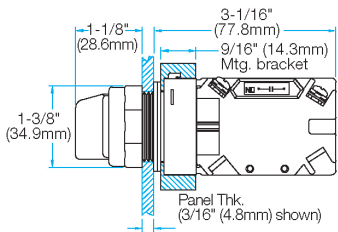

Selector Switch Lever Handle

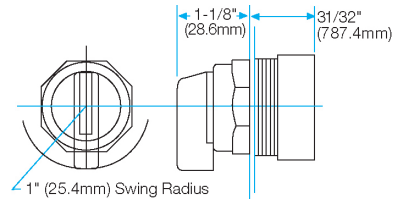

Selector Switch Mounting Bracket

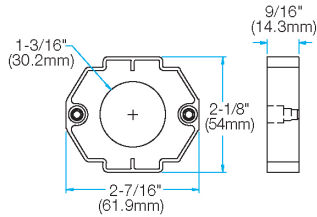

## H-line contact blocks

Factory Sealed Contact Block

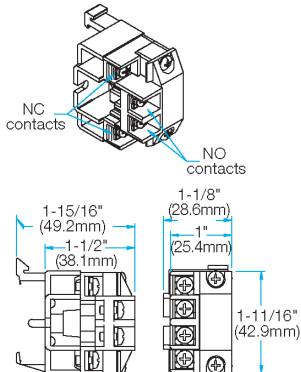

Power Reed, Mid-Power Reed & Medium Logic Reed Contact Blocks

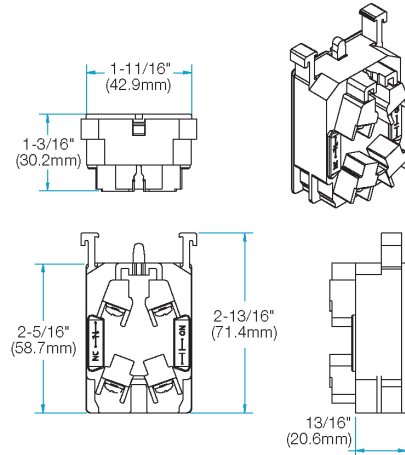

Logic Reed Contact Block

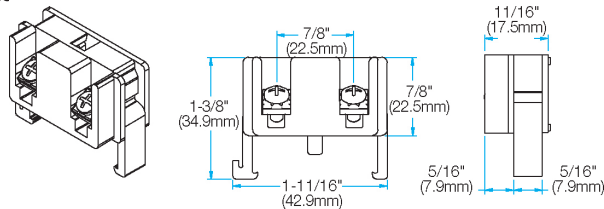

General Information
Circuit Protection
Disconnect Switches
Motor Protectors
Contactors
Overloads
Enclosed Starters
Relays
Pushbuttons and Pilot Lights
Terminal Blocks
Power Factor Correction
Appendix A
Appendix B

# Pushbuttons and Pilot Lights

## CSW30H Series (30mm) Hazardous Duty

General Information

Circuit Protection

Disconnect Switches

Motor Protectors

Contactors

Overloads

Enclosed Starters

Relays

Pushbuttons and Pilot Lights

Terminal Blocks

Power Factor Correction

### Maintained Flush & Extended h-line Push Button Caps

Fully-assembled operators come standard with one 3/16" (4.8mm) and three 1/16" (1.6mm) gaskets.

Maintained Extended Push Button Cap

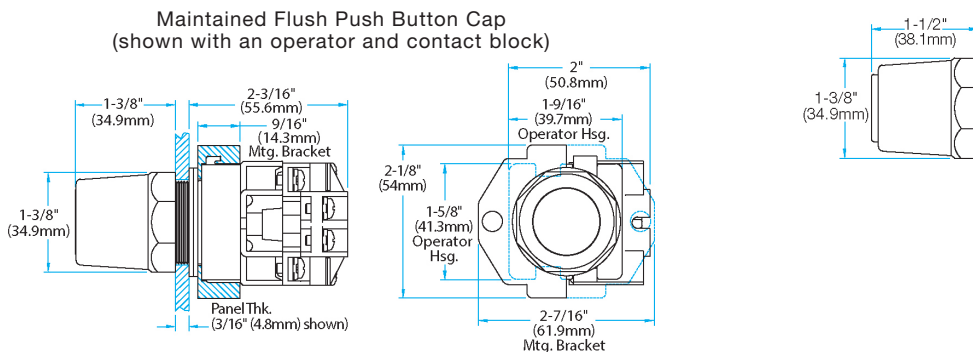

### H-line Reset Push Button

Fully-assembled operators come standard with one 3/16" (4.8mm) and three 1/16" (1.6mm) gaskets.

Reset Push Button

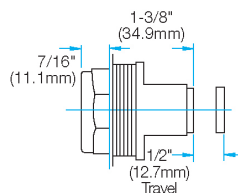

### GUARD ATTACHMENT

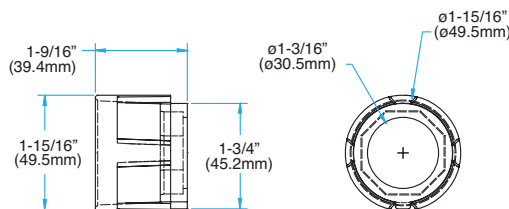

### Lock-off attachment

