

High Performance Multifunctional Inverters

FRENIC-MEGA Series



FRENIC

MEGA

Maximum Engineering for Global Advantage



FUJI ELECTRIC INVERTERS

With the flexibility and functionality to support a wide range of applications on all types of mechanical equipment, the FRENIC-MEGA takes core capability, responsiveness, environmental awareness, and easy maintenance to the next level.



The Inverter with the Highest Performance in the Industry.

FRENIC-MEGA is a high performance, multifunctional inverter Fuji Electric has developed by gathering the best of its technologies. With our own state-of-the-art technology, the control performance has evolved to a new dimension.

FRENIC-MEGA has been developed with unyielding standards of quality and flexibility to meet the demands of both simple and complex industrial applications. Meeting the requirements for various applications, achieving lower maintenance, and improved protection to environmental conditions.

FRENIC-MEGA, the inverter with the highest performance in the industry, is about to redefine the common sense of general-purpose inverters. Now, it is ready to provide a solution to your application needs!

FRENIC MEGA

Maximum Engineering for Global Advantage

FUJI ELECTRIC INVERTERS

With the flexibility and functionality to support a wide range of applications on all types of mechanical equipment, the FRENIC-MEGA takes core capability, responsiveness, environmental awareness, and easy maintenance to the next level.

Two types of keypads are available for FRENIC-MEGA: the multi-function keypad and the keypad with USB port. Allowing you to select and utilize a keypad interface that meets your application needs.



FRENIC-MEGA
+
Multi-function keypad



FRENIC-MEGA
+
Keypad with USB port (option)

High Performance Multifunctional Inverters

FRENIC-MEGA Series

Maximum Engineering for Global Advantage

Improved control performance

- I Available control methods: PG vector control, sensorless vector control, dynamic torque vector control, PG Closed-Loop control, and V/f control
- II Improved performance in current response and speed response (vector control)
- III Improved durability in overload operation
 - LD (Low duty) spec: 120% for 1 min
: For fans and pumps applications
 - MD (Medium duty) spec: 150% for 1 min
: For constant torque applications
 - HD (High duty) spec: 200% for 3 sec / 150% for 1 min
: For general industry applications

Easy maintainance

- I Multi-function keypad
- II Keypad with a USB Port (optional)
- III Maintenance warning signal output
- IV Long life cycle

Versatile applications

- I Various functions that accommodate a broad range of applications
Examples: customizable control logic through the built-in PLC functionality, pulse train input for speed and direction, ratio operation of the main speed, positioning control, output brake signal for mechanical braking control, etc...
- II Expanded power ratings for which the dynamic braking transistor is built-in
Provided as standard on models rated up through 40Hp(LD)
- III Connectivity to various networks
Ethernet TCP/IP, DeviceNet, Profibus DP, CC-Link, etc...
- IV Compliance with Safety Standard (EN954-1 Cat.3)
Safe torque off function that shuts off the power to the inverters output coasting the motor to a stop

Environmental Compatibility

- I Model variation meeting customers' needs
 - Standard Inverter
 - Inverter with DC Reactor Built-in
- II Compliance with RoHS Directives
- III Improved protection to environmental conditions



Safety Precautions

1. Use the contents of this catalog only for selecting product types and models. When using a product, read the Instruction Manual beforehand to use the product correctly.
2. Products introduced in this catalog have not been designed or manufactured for such applications in a system or equipment that will affect human bodies or lives. Customers, who want to use the products introduced in this catalog for special systems or devices such as for atomic-energy control, aerospace use, medical use, and traffic control, are requested to consult the Fuji's Sales Division. Customers are requested to prepare safety measures when they apply the products introduced in this catalog to such systems or facilities that will affect human lives or cause severe damage to property if the products become faulty.

Characteristics

Model Variations

Keypad Functionality

Inverter PC Software

Standard Specifications

Common Specifications

Basic Wiring Diagram

Terminal Functions

Function Settings

External Dimensions

Options

Reference material

Warranty

Best in class vector control for general-purpose inverters

Ideal for high accuracy positioning control

PG vector control

Effective in providing highly accurate control for applications such as printing presses.

Speed control range: 1:1500
 Speed response: 100Hz
 Speed control accuracy: $\pm 0.01\%$
 Current response: 500Hz
 Torque accuracy: $\pm 10\%$

* The option card is required separately.

* The above specifications may vary depending on the environment or conditions for use.

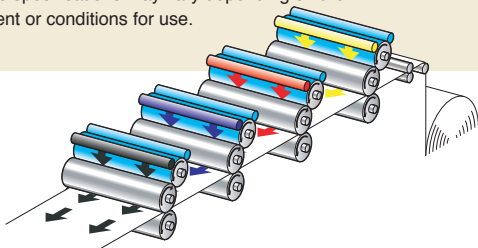

Maximizing motor performance

Speed sensor-less vector control

Useful for applications that require a high starting torque, such as the gondola type multi-level car parking tower

Speed control range: 1:200
 Speed response: 20Hz
 Speed control accuracy: $\pm 0.5\%$
 Current response: 500Hz
 Torque accuracy: $\pm 10\%$

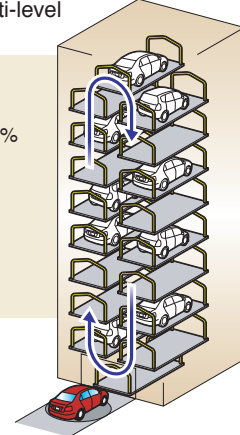

Further Improved Fuji's original dynamic torque vector control

In addition to the dynamic torque vector control, the inverter has a constant tuning mode of operation that will compensate for voltage errors in the main circuit devices. The inverter also utilizes a new magnetic flux observer for more precise operation. This allows for a high starting torque of 200%, even at low speed (0.3 Hz).

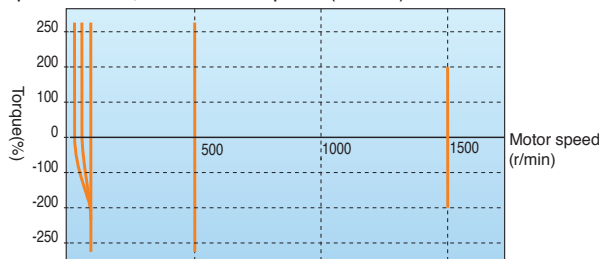

Example torque characteristics [5.5kW]

Improved reaction to fluctuation of an impact load

When a substantial load fluctuation occurs, the inverter provides a torque response that is best in class. It controls the flux to minimize the fluctuation in motor speed while suppressing the vibration. This function is best suited for the equipment that requires stable speed operation such as a cutting machine.

Example:

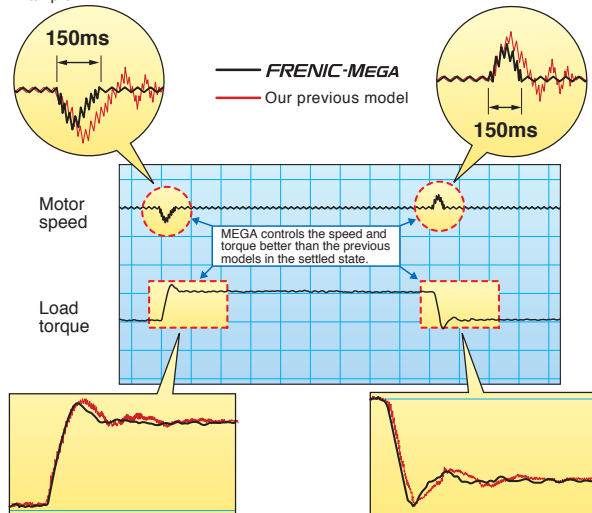

Improved durability in overload operation

The inverter performs quick acceleration and deceleration tasks, at maximum power, by extending the overload time as compared with previous models. This improves the operation efficiency of the applications such as cutting machines and conveyors.

Overload capability: 200% for 3s and 150% for 1 min.

The standard model is available in two specifications concerning the operation load.

Classification	Overload current rating	Major use
HD (High duty) spec	200% for 3 sec, 150% for 1 min	Operation under heavy load
MD (Medium duty) spec	150% for 1 min	Operation under constant torque load
LD (Low duty) spec	120% for 1 min	Operation under light load

Expanded power ratings for built-in braking transistor

For models with power ratings up through 40Hp(LD) the dynamic braking transistor is built-in and is provided as standard. This functionality is utilized for applications where the load requires additional deceleration control such as vertical conveyance machines.

* Power ratings on models up through 15Hp(LD) also include a dynamic braking resistor.

** For 460V power ratings on models of 50Hp(LD) through 250Hp(LD) the built-in dynamic braking transistor is available upon request.

Quicker response to the operation commands

The terminal response to the operation commands has an established reputation. FRENIC-MEGA has further shortened this response time, achieving an industry-best response time.

This function is effective in shortening the tact time per cycle and effective for use in the process including frequent repetitions.

Example:

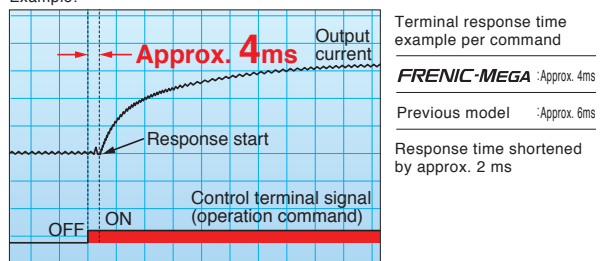

Terminal response time example per command

FRENIC-MEGA : Approx. 4ms

Previous model : Approx. 6ms

Response time shortened by approx. 2ms

Accommodating various applications

Convenient function for operation at a specified speed

The pulse train input function is provided as standard.

It is possible to issue a speed command with the pulse train input (single-phase pulse and a sign of command value) from a pulse generator, etc. (Maximum pulse input: 100kHz)

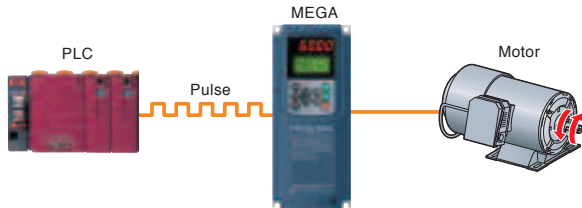

Speed Ratio operation

The Ratio operation function is used to adjust the speed differences between two different sections of a machine/process. Using one main speed reference, two or more inverters can have their speeds modified by an analog ratio signal. On conveyor systems, one conveyor can be made to run slightly faster to match speed with another based on gear box ratio differences.

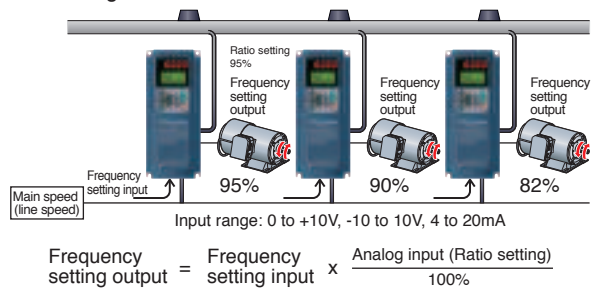

"Total" protection of the braking circuit

The inverter protects the braking resistor by monitoring the braking transistor operation. **The inverter outputs an exclusive signal on detection of the braking transistor abnormality.** A circuit for shutting off the input power supply must be provided outside of the inverter. When this signal is output, the power is shut off; thus protecting the braking circuit.

Applications with MEGA keep expanding

PG option card

This control function is best suited for the application that requires highly accurate positioning such as that of the conveyance machine. By combined use of the automatic position regulator (APR) and PG vector control, the position control accuracy has been remarkably improved. Shortened positioning time by this function will be helpful to reduce the tact time of a cycle.

Example: Fixed length marking system

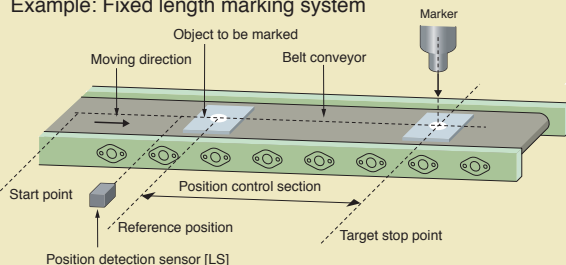

Optimum function for preventing an object from falling

The reliability of the brake signal was increased for uses such as vertical conveyance. Conventionally, the current value and the frequency have been monitored when the brake signal is output. By adding a torque value to these two values, the brake timing can be adjusted more easily.

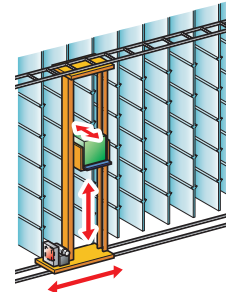

Dancer control function optimized for winding control

The PID value, which is calculated by comparing the target value and the feedback value, is added to or subtracted from the reference line speed. Since the PID calculator proportional gain can be adjusted to have a MEGA FAST response. The inverter can be applied to automatic control systems where quick response may be required.

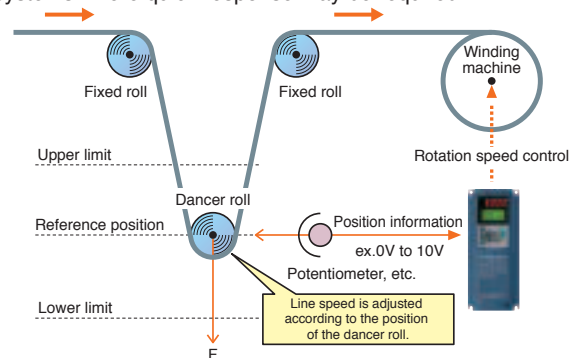

Extended functions for various applications

(1) Safety function meets EN954-1 Cat.3. (2) Analog inputs: voltage input through 2 terminals with polarity, current input through 1 terminal (3) Slow flowrate level stop function (Pressurized operation is possible before slow flowrate operation stop.) (4) Non-linear V/f pattern at 3 points (5) Dummy failure output function (6) Selection of up to the 4 motors (7) S-curve accel./decel. range setting (8) Detecting loss of PID feedback

Built-in PLC Functionality

Logic input/output can be easily created by parameter setting. This makes it possible to simplify the peripheral circuits.

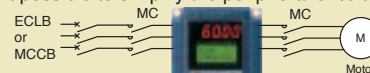

The interface is available in 10 steps using 2 inputs, 1 output, logical operation, and the timer function.

Introducing servo lock function (PG option card).

This function is effective in adjusting the stop timing or the braking torque when the equipment such as a conveyance machine is stopped by positioning of the motor. This function is helpful when torque is applied externally or holding torque is required during the stop time. The tact time per cycle will be reduced by shortened deceleration time.

Multi-function Keypad Type: TP-G1W-J1

Features:

- LCD with intelligent back-light feature for better viewing
- Large 7-segment LED with 5 digit display for excellent visibility from a distance
- Quick setup parameter list that can be customer modified
- Fully functional Remote/Local key for switching between operation commands and speed references
- 3 different parameter sets can be saved and copied
- Various display languages
English, Spanish, French, German, Italian and Japanese



Keypad with USB port Type: TP-E1U (Optional)

- The built-in USB port allows use of a personal computer loader software for easy information control!

Improved working efficiency at the manufacturing site

- A variety of data from the inverter can be saved in keypad memory, allowing you to check the information at any time.
- Data can be transferred from the USB port of the keypad directly to the computer (personal computer loader) at the manufacturing site.
- Periodical collection of life information can be carried out efficiently.
- The real-time tracing function permits the operator to check the equipment for abnormality.

Example of use in the office



Example of use in the manufacturing site



Features

1. The keypad can be directly connected to the computer through a commercial USB cable (Mini B) without using a converter. The computer can be connected on-line with the inverter.
2. With the personal computer loader software, the inverter can support the following functions (1) to (5).
 - (1) Editing, comparing, and copying the function code data
 - (2) Operation monitor, and real-time trace
 - (3) Alarm history (indicating the latest four alarms)
 - (4) Maintenance information
 - (5) Historical trace

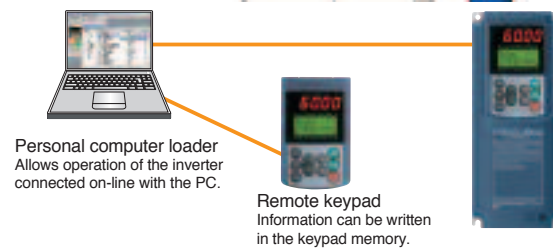

Connectivity

Built-in network functionality

■ RS-485 communication is provided as standard

In addition to the RJ-45 connection port which is shared with the inverter keypad, RS-485 terminals are provided as standard on the control terminal board allowing multi-drop network connections to be made easily.

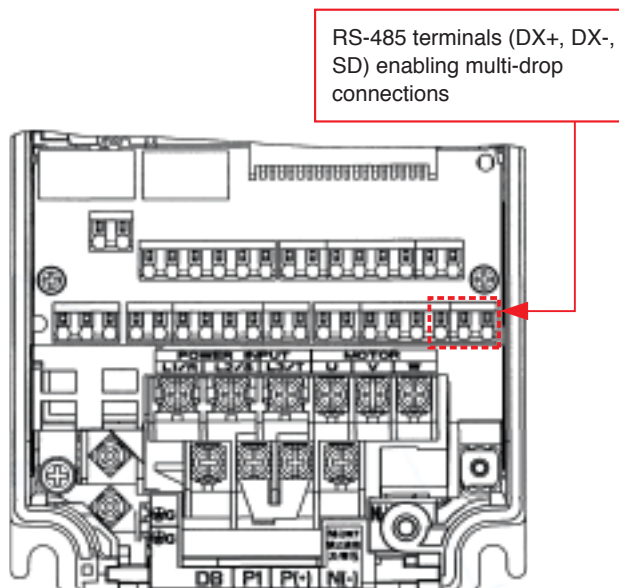
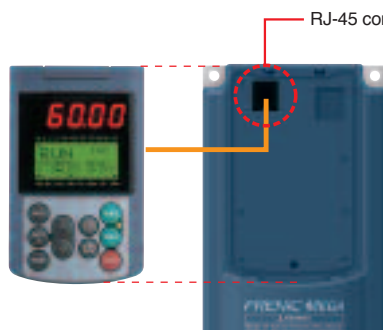

Available network option cards

- Ethernet TCP/IP
- CANopen
- T-Link interface card
- SX bus interface card
- DeviceNet
- CC-Link
- PROFIBUS DP

Prolonged service life and improved maintenance alarm function

10 Year design life

The design life for the replaceable components of the inverter is 10 years.

Replacement Part	Designed life
Main circuit capacitor	10 years
Electrolytic capacitor on PCB	10 years
Cooling fan	10 years

Conditional factors used for determining component design life are as follows:

the inverter is operated in an ambient air temperature of 40°C(104°F) and the average load is 80%(LD) or 100%(HD) of the inverter output rating.

* Design life values are calculated and not guaranteed.

Full support of maintenance warnings

The inverter is loaded with many different functions for facilitating maintenance of the equipment.

Item	Purpose
Cumulative inverter run time (h)	Displays the total run time of the inverter.
Number of inverter startups	Displays the number of times the inverter has started the equipment. Example of use: This data indicates the timing to replace the equipment parts (such as a timing belt) operating under the normal load.
Equipment maintenance warning Cumulative run time (h) Number of startups	By inputting the signal for operation with the commercial power supply, the time outside the inverter operation time can also be measured. This makes it possible to manage the total run time of the equipment and the number of startups. Such data is usable for preparing the maintenance schedule.
Display of inverter life warning	The displayed contents include: main circuit capacitor capacity, total run time of the cooling fan (with ON/OFF compensation), total run time of the electrolytic capacitor on the printed circuit board, and total run time of the inverter.

Environment Friendly Designed

Improved protection to environmental conditions

Protection to conditions of the installation environment has been improved as compared to the previous series of general purpose inverters.

- (1) The durability of the cooling fans has been improved to provide additional coatings and connector sealing.
- (2) Copper bus bars are provided with nickel (Ni) and tin (Sn) plating.

FRENIC-MEGA's protection to environmental conditions has been improved compared to FRENIC500G11S/P11S. However, careful examination of the installation environment prior to use of the inverter should be done under the following conditions:

- a. The environment is subject to sulfide gas (examples include: tire manufacturing, paper manufacturing, waste water processing, part of a textile process, etc...)
- b. The environment is subject to conductive dust or foreign matter (examples include: metalworking, extruding, printing, waste disposal, etc...)
- c. The environmental conditions exceed or do not match the environment specifications of the inverter.

For applications planning to utilize the inverter in any of the above environmental conditions please consult with Fuji Electric.

Compliance with RoHS Directives

MEGA complies with European regulations that limit the use of specific hazardous substances (RoHS) as a standard. This inverter is environment-friendly as the use of the following six hazardous substances is restricted.

Lead, mercury, cadmium, hexavalent chromium, polybrominated biphenyl (PBB), and polybrominated biphenyl ether (PBDE)

The Directive 2002/96/EC, promulgated by the European Parliament and European Council, limits the use of specific hazardous substances included in electrical and electronic devices.

Global compatibility

● Application to the world standards pending

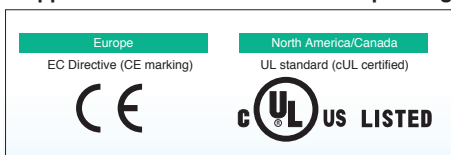

● Wide voltage range

Applicable to 480V and 240V power supplies as standard



Model Variations

Model list LD : Low Duty spec 120% for 1 min
MD : Medium Duty spec 150% for 1min
HD : High Duty spec 200% for 3 sec, 150% for 1min

Nominal applied motor (HP)	Standard Inverter				
	Three-phase 230 V series		Three-phase 460 V series		
	LD spec (120%)	HD spec (150%)	LD spec (120%)	MD spec (150%)	HD spec (150%)
0.5	FRNF50G1S-2U	FRNF50G1S-2U	FRNF50G1S-4U		FRNF50G1S-4U
1	FRN001G1S-2U	FRN001G1S-2U	FRN001G1S-4U		FRN001G1S-4U
2	FRN002G1S-2U	FRN002G1S-2U	FRN002G1S-4U		FRN002G1S-4U
3	FRN003G1S-2U	FRN003G1S-2U	FRN003G1S-4U		FRN003G1S-4U
5	FRN005G1S-2U	FRN005G1S-2U	FRN005G1S-4U		FRN005G1S-4U
7.5	FRN007G1S-2U	FRN007G1S-2U	FRN007G1S-4U		FRN007G1S-4U
7.5		FRN010G1S-2U			FRN010G1S-4U
10	FRN010G1S-2U	FRN015G1S-2U	FRN010G1S-4U		FRN015G1S-4U
15	FRN015G1S-2U	FRN020G1S-2U	FRN015G1S-4U		FRN020G1S-4U
20	FRN020G1S-2U	FRN025G1S-2U	FRN020G1S-4U		FRN025G1S-4U
25	FRN025G1S-2U	FRN030G1S-2U	FRN025G1S-4U		FRN030G1S-4U
30	FRN030G1S-2U	FRN040G1S-2U	FRN030G1S-4U		FRN040G1S-4U
40	FRN040G1S-2U	FRN050G1S-2U	FRN040G1S-4U		FRN050G1S-4U
50	FRN050G1S-2U	FRN060G1S-2U	FRN050G1S-4U		FRN060G1S-4U
60	FRN060G1S-2U	FRN075G1S-2U	FRN060G1S-4U		FRN075G1S-4U
75	FRN075G1S-2U	FRN100G1S-2U	FRN075G1S-4U		FRN100G1S-4U
100	FRN100G1S-2U	FRN125G1S-2U	FRN100G1S-4U		FRN125G1S-4U
125	FRN125G1S-2U	FRN150G1S-2U	FRN125G1S-4U		FRN150G1S-4U
150	FRN150G1S-2U		FRN150G1S-4U	FRN150G1S-4U	FRN200G1S-4U
200			FRN200G1S-4U	FRN200G1S-4U	FRN250G1S-4U
250			FRN250G1S-4U	FRN250G1S-4U	FRN300G1S-4U
300			FRN300G1S-4U	FRN300G1S-4U	FRN350G1S-4U
350			FRN350G1S-4U	FRN350G1S-4U	FRN450G1S-4U
350				FRN450G1S-4U	
400					FRN500G1S-4U
450			FRN450G1S-4U	FRN500G1S-4U	FRN600G1S-4U
500			FRN500G1S-4U	FRN600G1S-4U	FRN700G1S-4U
600			FRN600G1S-4U	FRN700G1S-4U	FRN800G1S-4U
700			FRN700G1S-4U	FRN800G1S-4U	
800			FRN800G1S-4U		FRN900G1S-4U
900			FRN900G1S-4U		FRN1000G1S-4U
1000			FRN1000G1S-4U		

How to read the inverter model

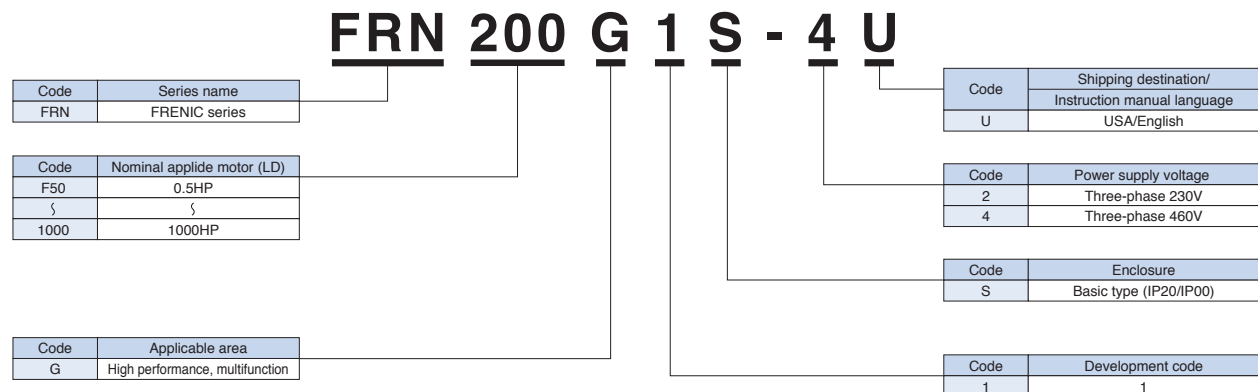

*A multi-function keypad (TP-G1W-J1) is included as standard equipment for inverters. Please select and use remote control keypad (TP-E1U) as option, if necessary.
*The external DC reactor is included as standard for 100HP and above. DC Reactor listed on reference section in this catalog.

Caution The contents of this catalog are provided to help you select the product model that is best for you. Before the actual use, be sure to read the User's Manual thoroughly for proper operations.

Characteristics
Model Variations
Keypad Functionality
Inverter PC Softw
Standard Specifications
Common Specifications
Basic Wiring Diagram
Terminal Functions
Function Settings
External Dimensions
Options
Reference material
Warranty

Keypad Functionality

Multi-function keypad

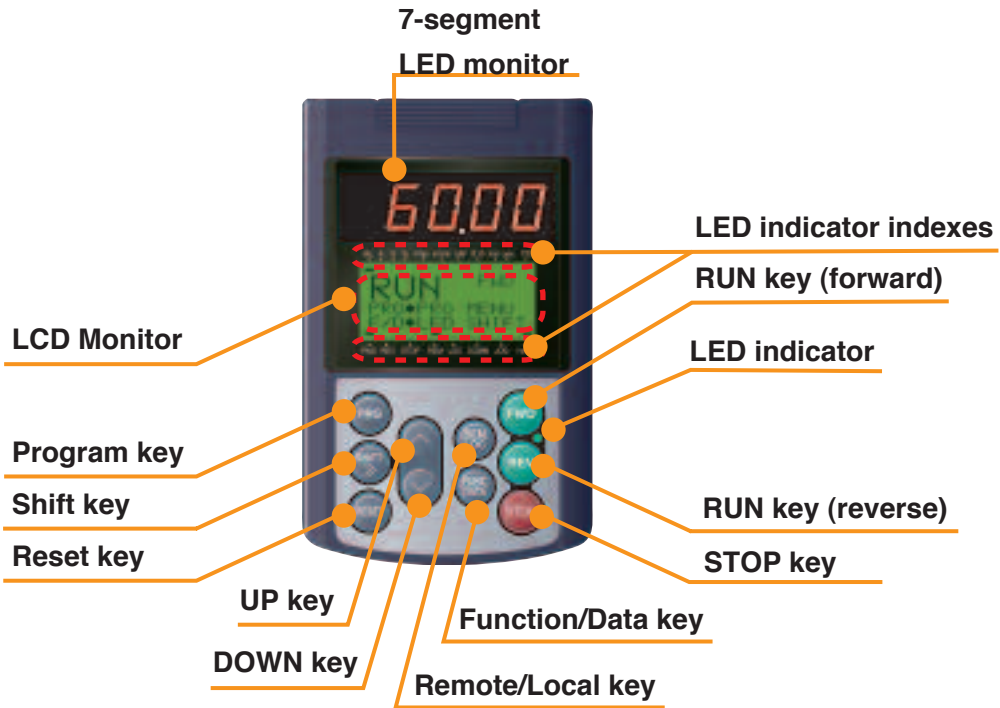

Item	Monitor, LED indicator or Key	Functionality
LED/LCD Monitor		Five-digit, 7-segment LED monitor which displays the following according to the operation mode: ■ In Running Mode: Running status information (e.g., output frequency, current, and voltage) ■ In Programming Mode: same as above ■ In Alarm Mode: Alarm code, which identifies the cause of alarm if the protective function is activated.
		LCD monitor which displays the following according to the operation modes: ■ In Running Mode: Running status information ■ In Programming Mode: Menus, function codes and their data ■ In Alarm Mode: Alarm code, which identifies the cause of alarm if the protective function is activated.
	LED indicator indexes	In running mode, display the unit of the number displayed on the LED monitor and the running status information shown on the LCD monitor. For details, see next page.
Keypad Operation Key		Switches the operation modes of the inverter.
		Shifts the cursor to the right when entering a number.
		Pressing this key after removing the cause of an alarm will switch the inverter to Running Mode. Used to reset a setting or screen transition.
		UP and DOWN keys. Used to select the setting items or change the function code data displayed on the LED monitor.
Run Operation Key		Starts running the motor (forward rotation).
		Starts running the motor (reverse rotation).
		Stops the motor.
		Pressing this toggle key for more than 1 second switches between Local and Remote modes.
LED Indicator		Lights while a run command is supplied to the inverter.

Type	Item	Description (information, condition, status)
Unit of Number Displayed on LED Monitor	Hz	Output frequency, frequency command
	A	Output current
	V	Output voltage
	%	Calculated torque, load factor, speed
	r/min	Motor speed, set motor speed, load shaft speed, set load shaft speed
	m/min	Line speed, set line speed
	kW	Input power, motor output
	X10	Data greater than 99,999
	min	Constant feeding rate time, constant feeding rate time setting
	sec	Timer
Operating Status	FWD	Running (forward rotation)
	REV	Running (reverse rotation)
	STOP	No output frequency
Source of Operation	REM	Remote mode
	LOC	Local mode
	COMM	Communication enabled (RS-485 (standard, optional), field bus option)
	JOG	Jogging mode
	HAND	Keypad effective (lights also in local mode)

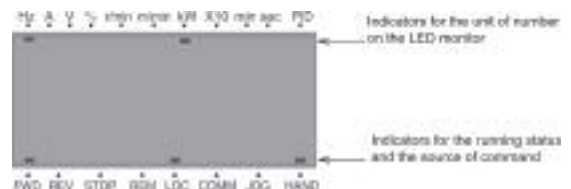

Inverter PC Software

Full-fledged maintenance with the FRENIC loader software

- Editing, comparing, copying and downloading of the function code data
- Operation monitor, real-time historical trace, trouble monitor, and multi-monitor
- Test run, motor auto tuning

- Compatibility with Windows2000 and XP is guaranteed.
- The real-time trace function monitors the inverter operating conditions with waveforms in a multi-channel graph format, and the results can be stored in a data file. The stored data can be used for motion analysis etc.

* The loader software can be downloaded for free from FUJI's website.
<http://www.americas.fujielectric.com>

Function code list editing

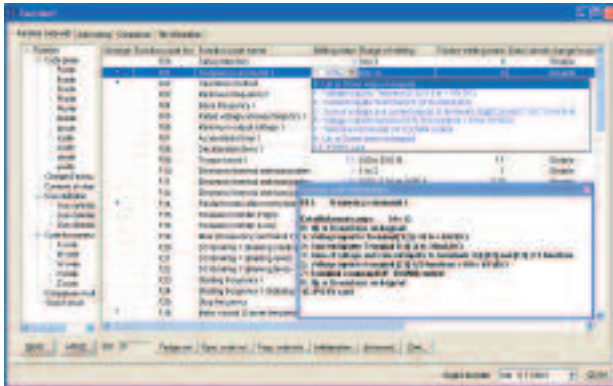

Historical trace

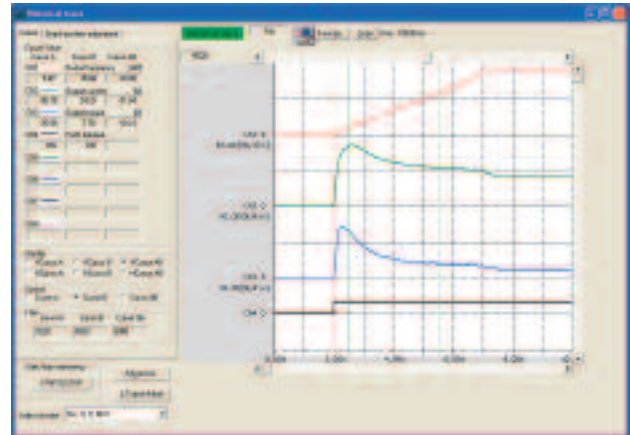

Operation monitor

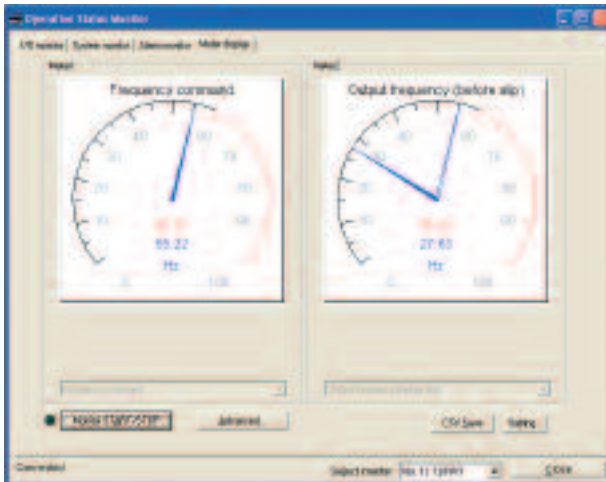

Test run screen



Maintenance information

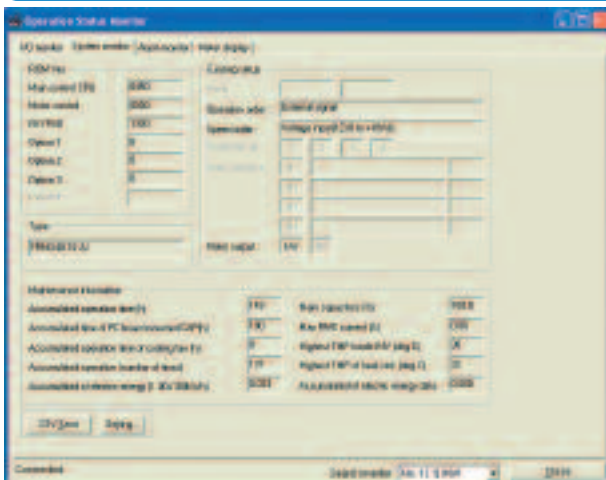

Characteristics

Model Variations

Keypad Functionality

Inverter PC Software

Standard Specifications

Common Specifications

Basic Wiring Diagram

Terminal Functions

Function Settings

External Dimensions

Options

Reference material

Warranty

Standard Specifications (Standard Inverter)

Three-phase 230V series

LD (Low Duty)-mode inverters for light load

(0.5 to 150 HP)

Item		Specifications																	
Type (FRN□□□G1S-2U)		F50	001	002	003	005	007	010	015	020	025	030	040	050	060	075	100	125	150
Nominal applied motor (HP) (Output rating) *1		0.5	1	2	3	5	7.5	10	15	20	25	30	40	50	60	75	100	125	150
Rated capacity (kVA) *2		1.2	2.0	3.2	4.4	7.2	11	13	18	24	30	35	46	58	72	86	113	138	165
Output ratings	Rated voltage (V) *3	Three-phase 200 to 240 V (with AVR function)											Three-phase 200 to 230 V (with AVR function)						
	Rated current (A) *4	3	5	8	11	18	27	31.8 (29)	46.2 (42)	59.4 (55)	74.8 (68)	88 (80)	115 (107)	146	180	215	283	346	415
Overload capability		150%-1 min, 200%-3.0 s						120%-1 min											
Input power	Voltage, frequency	200 to 240 V, 50/60 Hz											200 to 220 V, 50 Hz, 200 to 230 V, 60 Hz						
	Allowable voltage/frequency	Voltage: +10 to -15% (Interphase voltage unbalance: 2% or less) *5, Frequency: +5 to -5%																	
Required capacity (with DCR) (kVA) *6		0.6	1.2	2.2	3.1	5.2	7.4	10.0	15.0	20.0	25.0	30.0	40.0	48.0	58.0	71.0	98.0	116	143
Braking	Torque (%) *7	150%			100%			70%			15%			7 to 12%					
	Braking transistor	Built-in																	
	Built-in braking resistor	Built-in																	
	Braking time (s)	5 s						3.7 s			3.4 s			—					
Duty cycle (%ED)		5	3	5	3	2	2.2	1.4											
DC reactor (DCR)		Option																Standard *8	
Applicable safety standards		UL508C, C22.2 No.14, EN61800-5-1:2007																	
Enclosure (IEC60529)		IP20, UL open type											IP00, UL open type						
Cooling method		Natural cooling						Fan cooling											
Weight / Mass lbs (kg)		3.8 (1.7)	4.4 (2.0)	6.2 (2.8)	6.6 (3.0)	6.6 (3.0)	14 (6.5)	14 (6.5)	14 (6.5)	13 (5.8)	21 (9.5)	21 (9.5)	22 (10)	55 (25)	71 (32)	93 (42)	95 (43)	137 (62)	232 (105)

HD (High Duty)-mode inverters for heavy load

(0.5 to 125 HP)

Item		Specifications																		
Type (FRN□□□G1S-2U)		F50	001	002	003	005	007	010	015	020	025	030	040	050	060	075	100	125	150	
Nominal applied motor (HP) (Output rating) *1		0.5	1	2	3	5	7.5	7.5	10	15	20	25	30	40	50	60	75	100	125	
Rated capacity (kVA) *2		1.2	2.0	3.2	4.4	7.2	11	11	15	20	25	30	36	47	58	72	86	113	138	
Output ratings	Rated voltage (V) *3	Three-phase 200 to 240 V (with AVR function)											Three-phase 200 to 230 V (with AVR function)							
	Rated current (A)	3	5	8	11	18	27	27	37	49	63	76	90	119	146	180	215	283	346	
Overload capability		150%-1 min, 200%-3.0 s																		
Input power	Voltage, frequency	200 to 240 V, 50/60 Hz											200 to 220 V, 50 Hz, 200 to 230 V, 60 Hz							
	Allowable voltage/frequency	Voltage: +10 to -15% (Interphase voltage unbalance: 2% or less) *5, Frequency: +5 to -5%																		
Required capacity (with DCR) (kVA) *6		0.6	1.2	2.2	3.1	5.2	7.4	7.4	10	15	20	25	30	40	48	58	71	98	116	
Braking	Torque (%) *7	150%			100%			20%			10 to 15%									
	Braking transistor	Built-in																		
	Built-in braking resistor	Built-in																		
	Braking time (s)	5 s									—									
Duty cycle (%ED)		5	3	5	3	2	3	3	2											
DC reactor (DCR)		Option																Standard *8		
Applicable safety standards		UL508C, C22.2 No.14, EN61800-5-1:2007																		
Enclosure (IEC60529)		IP20, UL open type											IP00, UL open type							
Cooling method		Natural cooling						Fan cooling												
Weight / Mass lbs (kg)		3.8 (1.7)	4.4 (2.0)	6.2 (2.8)	6.6 (3.0)	6.6 (3.0)	14 (6.5)	14 (6.5)	14 (6.5)	13 (5.8)	21 (9.5)	21 (9.5)	22 (10)	55 (25)	71 (32)	93 (42)	95 (43)	137 (62)	232 (105)	

*1 US-4P standard induction motor

*2 Rated capacity is calculated assuming the rated output voltage as 230 V for 230 V series and 460 V for 460 V series.

*3 Output voltage cannot exceed the power supply voltage.

*4 To use the inverter with the carrier frequency of 3 kHz or more at the surrounding temperature of 40°C (104°F) or higher, manage the load so that the current comes to be within the rated ones enclosed in parentheses () in continuous running.

*5 $\text{Voltage unbalance(\%)} = \frac{\text{Max. voltage (V)} - \text{Min. voltage (V)}}{\text{Three-phase average voltage (V)}} \times 67(\text{IEC 61800-3})$

If this value is 2 to 3%, use an optional AC reactor (ACR).

*6 Required when a DC reactor (DCR) is used.

*7 Average braking torque for the motor running alone, without external braking resistor. (It varies with the efficiency of the motor.)

*8 The FRN100G1S-2U or higher type comes with a DC reactor (DCR).

Three-phase 460V series

LD (Low Duty)-mode inverters for light load

(0.5 to 100 HP)

Item		Specifications																	
Type (FRN□□□G1S-4U)		F50	001	002	003	005	007	010	015	020	025	030	040	050	060	075	100		
Output ratings	Nominal applied motor (HP) (Output rating) *1	0.5	1	2	3	5	7.5	10	15	20	25	30	40	50	60	75	100		
	Rated capacity (kVA) *2	1.2	2.0	3.2	4.4	7.2	11	13.1	18.3	24	29	36	48	60	73	89	120		
	Rated voltage (V) *3	Three-phase 380 to 480 V (with AVR function)																	
	Rated current (A)	1.5	2.5	4	5.5	9	13.5	16.5	23	30.5	37	45	60	75	91	112	150		
Input power	Overload capability	150%-1 min, 200%-3.0 s						120%-1 min											
	Voltage, frequency	380 to 480 V, 50/60 Hz																	
	Allowable voltage/frequency	Voltage: +10 to -15% (Interphase voltage unbalance: 2% or less) *4, Frequency: +5 to -5%																	
	Required capacity (with DCR) (kVA) *5	0.6	1.2	2.2	3.1	5.2	7.4	10	15	20	25	29	40	48	58	71	96		
Braking	Torque (%) *6	150%			100%			70%			15%			7 to 12%					
	Braking transistor	Built-in																	
	Built-in braking resistor	Built-in																	
	Braking time (s)	5 s						3.7 s			3.4 s			—					
DC reactor (DCR)	Duty cycle (%ED)	5	3	5	3	2	2.2		1.4		—								
	DC reactor (DCR)	Option															Standard *7		
Applicable safety standards	UL508C, C22.2 No.14, EN61800-5-1:2007																		
Enclosure (IEC60529)	IP20, UL open type												IP00, UL open type						
Cooling method	Natural cooling						Fan cooling												
Weight / Mass lbs (kg)	3.8	4.4	5.7	6.0	6.6	14	14	14	13	21	21	22	55	57	68	73			
	(1.7)	(2.0)	(2.6)	(2.7)	(3.0)	(6.5)	(6.5)	(6.5)	(5.8)	(9.5)	(9.5)	(10)	(25)	(26)	(31)	(33)			

(125 to 1000 HP)

Item		Specifications																	
Type (FRN□□□G1S-4U)		125	150	200	250	300	350	450	500	600	700	800	900	1000					
Output ratings	Nominal applied motor (HP) (Output rating) *1	125	150	200	250	300	350	450	500	600	700	800	900	1000					
	Rated capacity (kVA) *2	140	167	202	242	300	331	414	518	590	669	765	932	1092					
	Rated voltage (V) *3	Three-phase 380 to 480 V (with AVR function)																	
	Rated current (A)	176	210	253	304	377	415	520	650	740	840	960	1170	1370					
Input power	Overload capability	120%-1 min																	
	Voltage, frequency	380 to 440 V, 50 Hz 380 to 480 V, 60 Hz																	
	Allowable voltage/frequency	Voltage: +10 to -15% (Interphase voltage unbalance: 2% or less) *4, Frequency: +5 to -5%																	
	Required capacity (with DCR) (kVA) *5	114	140	165	199	248	271	347	436	489	547	611	773	871					
Braking	Torque (%) *6	7 to 12%																	
	Braking transistor	—																	
	Built-in braking resistor	—																	
	Braking time (s)	—																	
DC reactor (DCR)	Duty cycle (%ED)	—																	
	DC reactor (DCR)	Standard *7																	
Applicable safety standards	UL508C, C22.2 No.14, EN61800-5-1:2007																		
Enclosure (IEC60529)	IP00, UL open type																		
Cooling method	Fan cooling																		
Weight / Mass lbs (kg)	93	137	141	207	216	284	309	540	540	728	728	1169	1169						
	(42)	(62)	(64)	(94)	(98)	(129)	(140)	(245)	(245)	(330)	(330)	(530)	(530)						

*1 US-4P standard induction motor

*2 Rated capacity is calculated assuming the rated output voltage as 230 V for 230 V series and 460 V for 460 V series.

*3 Output voltage cannot exceed the power supply voltage.

*4 Voltage unbalance(%) = $\frac{\text{Max. voltage (V)} - \text{Min. voltage (V)}}{\text{Three-phase average voltage (V)}} \times 67$ (IEC 61800-3)

If this value is 2 to 3%, use an optional AC reactor (ACR).

*5 Required when a DC reactor (DCR) is used.

*6 Average braking torque for the motor running alone, without external braking resistor. (It varies with the efficiency of the motor.)

*7 The FRN100G1S-4U or higher type comes with a DC reactor (DCR).

Standard Specifications (Standard Inverter)

Three-phase 460V series

MD (Medium Duty)-mode inverters for medium load

(150 to 700 HP)

Item		Specifications															
Type (FRN□□□G1S-4U)	150	200	250	300	350	450	500	600	700	800							
Nominal applied motor (HP) (Output rating)*1	150	200	250	300	350	350	450	500	600	700							
Output ratings	Rated capacity (kVA) *2	167	202	242	300	331	373	466	518	590	669						
	Rated voltage (V) *3	Three-phase 380 to 480 V (with AVR function)															
	Rated current (A)	210	253	304	377	415	468	585	650	740	840						
	Overload capability	150%-1 min															
Input power	Voltage, frequency	380 to 440 V, 50 Hz 380 to 480 V, 60 Hz															
	Allowable voltage/frequency	Voltage: +10 to -15% (Interphase voltage unbalance: 2% or less) *4, Frequency: +5 to -5%															
	Required capacity (with DCR) (kVA) *5	140	165	199	248	271	308	388	436	489	547						
Braking	Torque (%) *6	7 to 12%															
	Braking transistor	—															
	Built-in braking resistor	—															
		Braking time (s)	—														
Duty cycle (%ED)	—																
DC reactor (DCR)	Standard *7																
Applicable safety standards	UL508C, C22.2 No.14, EN61800-5-1:2007																
Enclosure (IEC60529)	IP00, UL open type																
Cooling method	Fan cooling																
Weight / Mass lbs (kg)	137 (62)	141 (64)	207 (94)	216 (98)	284 (129)	309 (140)	540 (245)	540 (245)	728 (330)	728 (330)							

*1 US-4P standard induction motor

*2 Rated capacity is calculated assuming the rated output voltage as 230 V for 230 V series and 460 V for 460 V series.

*3 Output voltage cannot exceed the power supply voltage.

*4 $\text{Voltage unbalance(\%)} = \frac{\text{Max. voltage (V)} - \text{Min. voltage (V)}}{\text{Three-phase average voltage (V)}} \times 67$ (IEC 61800-3)

If this value is 2 to 3%, use an optional AC reactor (ACR).

*5 Required when a DC reactor (DCR) is used.

*6 Average braking torque for the motor running alone, without external braking resistor. (It varies with the efficiency of the motor.)

*7 The FRN100G1S-4U or higher type comes with a DC reactor (DCR).

Three-phase 460V series

HD (High Duty)-mode inverters for heavy load

(0.5 to 75 HP)

Item		Specifications																	
Type (FRN□□□G1S-4U)		F50	001	002	003	005	007	010	015	020	025	030	040	050	060	075	100		
Output ratings	Nominal applied motor (HP) (Output rating) *1	0.5	1	2	3	5	7.5	7.5	10	15	20	25	30	40	50	60	75		
	Rated capacity (kVA) *2	1.2	2.0	3.2	4.4	7.2	11	11	15	20	25	31	36	48	60	73	89		
Input power	Rated voltage (V) *3	Three-phase 380 to 480 V (with AVR function)																	
	Rated current (A)	1.5	2.5	4	5.5	9	13.5	13.5	18.5	24.5	32	39	45	60	75	91	112		
	Overload capability	150%-1 min, 200%-3.0 s																	
	Voltage, frequency	380 to 480 V, 50/60 Hz																	
Braking	Allowable voltage/frequency	Voltage: +10 to -15% (Interphase voltage unbalance: 2% or less) *4, Frequency: +5 to -5%																	
	Required capacity (with DCR) (kVA) *5	0.6	1.2	2.1	3.2	5.3	7.4	7.4	9.9	15.0	20.0	25.0	29.0	40.0	48.0	58.0	71.0		
	Torque (%) *6	150%			100%						15%			10 to 15%					
DC reactor (DCR)	Braking transistor	Built-in																	
	Built-in braking resistor	Built-in																	
	Braking time (s)	5 s																	
Applicable safety standards	Duty cycle (%ED)	5	3	5	3	2	3	3	2										
	DC reactor (DCR)	Option																Standard *7	
Enclosure (IEC60529)	IP20, UL open type												IP00, UL open type						
Cooling method	Natural cooling								Fan cooling										
Weight / Mass lbs (kg)	3.8	4.4	5.7	6.0	6.6	14	14	14	13	21	21	22	55	57	68	73			
	(1.7)	(2.0)	(2.6)	(2.7)	(3.0)	(6.5)	(6.5)	(6.5)	(5.8)	(9.5)	(9.5)	(10)	(25)	(26)	(31)	(33)			

(100 to 900 HP)

Item		Specifications																	
Type (FRN□□□G1S-4U)		125	150	200	250	300	350	450	500	600	700	800	900	1000					
Output ratings	Nominal applied motor (HP) (Output rating) *1	100	125	150	200	250	300	350	400	450	500	600	800	900					
	Rated capacity (kVA) *2	120	140	167	202	242	300	330	414	466	518	590	765	932					
Input power	Rated voltage (V) *3	Three-phase 380 to 480 V (with AVR function)																	
	Rated current (A)	150	176	210	253	304	377	415	520	585	650	740	960	1170					
	Overload capability	150%-1 min, 200%-3.0 s																	
	Voltage, frequency	380 to 440 V, 50 Hz 380 to 480 V, 60 Hz																	
Braking	Allowable voltage/frequency	Voltage: +10 to -15% (Interphase voltage unbalance: 2% or less) *4, Frequency: +5 to -5%																	
	Required capacity (with DCR) (kVA) *5	96	114	140	165	199	248	271	347	388	436	489	611	773					
	Torque (%) *6	10 to 15%																	
DC reactor (DCR)	Braking transistor	—																	
	Built-in braking resistor	—																	
	Braking time (s)	—																	
Applicable safety standards	Duty cycle (%ED)	—																	
	DC reactor (DCR)	Standard *7																	
Enclosure (IEC60529)	IP00, UL open type																		
Cooling method	Fan cooling																		
Weight / Mass lbs (kg)	93	137	141	207	216	284	309	540	540	728	728	1169	1169						
	(42)	(62)	(64)	(94)	(98)	(129)	(140)	(245)	(245)	(330)	(330)	(530)	(530)						

*1 US-4P standard induction motor

*2 Rated capacity is calculated assuming the rated output voltage as 230 V for 230 V series and 460 V for 460 V series.

*3 Output voltage cannot exceed the power supply voltage.

*4 $\text{Voltage unbalance(\%)} = \frac{\text{Max. voltage (V)} - \text{Min. voltage (V)}}{\text{Three-phase average voltage (V)}} \times 67(\text{IEC 61800-3})$





If this value is 2 to 3%, use an optional AC reactor (ACR).

*5 Required when a DC reactor (DCR) is used.

*6 Average braking torque for the motor running alone, without external braking resistor. (It varies with the efficiency of the motor.)

*7 The FRN100G1S-4U or higher type comes with a DC reactor (DCR).

Common Specifications

Item		Explanation	
Output frequency	Setting range	Maximum frequency 25 to 500 Hz (120 Hz for inverters in MD/LD mode) (120 Hz under vector control without speed sensor, 200 Hz under vector control with speed sensor)	
		Base frequency 25 to 500 Hz (in conjunction with the maximum frequency)	
		Starting frequency 0.1 to 60.0 Hz (0.0 Hz under vector control with/without speed sensor)	
		Carrier frequency <ul style="list-style-type: none"> • 0.75 to 16 kHz (HD mode: 0.5 to 100 HP, LD mode: 7 to 30 HP) • 0.75 to 10 kHz (HD mode: 120 to 800 HP, LD mode: 40 to 100 HP) • 0.75 to 6 kHz (HD mode: 900 and 1000 HP, LD mode: 125 to 900 HP) • 0.75 to 4 kHz (LD mode: 100 HP) • 0.75 to 2 kHz (MD mode: 150 to 800 HP) Note: The carrier frequency may automatically drop depending upon the surrounding temperature or output current to protect the inverter. (The automatic drop function can be disabled.)	
	Accuracy (Stability)	<ul style="list-style-type: none"> • Analog setting: $\pm 0.2\%$ of maximum frequency (at $25 \pm 10^\circ\text{C}$ ($77 \pm 18^\circ\text{F}$)) • Keypad setting: $\pm 0.01\%$ of maximum frequency (at -10 to $+50^\circ\text{C}$ (14 to 122°F)) 	
	Setting resolution	<ul style="list-style-type: none"> • Analog setting: 1/3000 of maximum frequency (1/1500 for V2 input) • Keypad setting: 0.01 Hz (99.99 Hz or less), 0.1 Hz (100.0 to 500.0 Hz) • Link operation setting: Selectable from the following two types <ul style="list-style-type: none"> - 1/20000 of maximum frequency - 0.01 Hz (fixed) 	
	Under V/f control with speed sensor Under dynamic torque vector control with speed sensor	Speed control range	<ul style="list-style-type: none"> • 1 : 100 (Minimum speed: Base speed, 4P, 15 to 1500 r/min) • 1 : 2 (Constant torque range: Constant output range)
		Speed control accuracy	<ul style="list-style-type: none"> • Analog setting: $\pm 0.2\%$ of maximum frequency (at $25 \pm 10^\circ\text{C}$ ($77 \pm 18^\circ\text{F}$)) • Digital setting: $\pm 0.01\%$ of maximum frequency (at -10 to $+50^\circ\text{C}$ (14 to 122°F))
	Under vector control without speed sensor	Speed control range	<ul style="list-style-type: none"> • 1 : 200 (Minimum speed: Base speed, 4P, 7.5 to 1500 r/min) • 1 : 2 (Constant torque range: Constant output range)
		Speed control accuracy	<ul style="list-style-type: none"> • Analog setting: $\pm 0.5\%$ of base speed (at $25 \pm 10^\circ\text{C}$ ($77 \pm 18^\circ\text{F}$)) • Digital setting: $\pm 0.5\%$ of base speed (at -10 to $+50^\circ\text{C}$ (14 to 122°F))
Under vector control with speed sensor	Speed control range	<ul style="list-style-type: none"> • 1 : 1500 (Minimum speed: Base speed, 4P, 1 to 1500 r/min, 1024 p/r) • 1 : 4 (Constant torque range: Constant output range) 	
	Speed control accuracy	<ul style="list-style-type: none"> • Analog setting: $\pm 0.2\%$ of maximum frequency (at $25 \pm 10^\circ\text{C}$ ($77 \pm 18^\circ\text{F}$)) • Digital setting: $\pm 0.01\%$ of maximum frequency (at -10 to $+50^\circ\text{C}$ (14 to 122°F)) 	
Control	Control method	<ul style="list-style-type: none"> • V/f control • Dynamic torque vector control • V/f control with speed sensor or dynamic torque vector control with speed sensor • Vector control without speed sensor (Not available for MD-mode inverters) • Vector control with speed sensor (with an optional PG interface card mounted) 	
	V/f characteristics	<ul style="list-style-type: none"> • Possible to set output voltage at base frequency and at maximum frequency • AVR control ON/OFF selectable. Non-linear V/f pattern with three arbitrary points. 	
	Torque boost	<ul style="list-style-type: none"> • Auto torque boost (for constant torque load) • Manual torque boost: Desired torque boost (0.0 to 20.0%) can be set. • Select application load with function code F37. (Variable torque load or constant torque load) 	
	Starting torque	30Hp (HD) or below: 200% or over, 40Hp (HD) or above: 180% or over Reference frequency: 0.3 Hz with slip compensation and auto torque boost	
	Start/stop operation	<ul style="list-style-type: none"> • Keypad ( and  keys), external signals (run forward (run reverse) command etc.), Communications link (RS-485 or fieldbus (option)) • Remote/local operation 	
	Enable input (Safety stop function)	Opening the circuit between terminals [EN] and [PLC] stops the inverter's output transistor (coast-to-stop). (Compliant with EN954-1 Cat.3)	
	Frequency command	<ul style="list-style-type: none"> • Keypad:  and  keys • Analog input (Analog input can be set with external voltage/current input): 0 to ± 10 VDC/0 to $\pm 100\%$ (terminals [I2], [V2]) $+4$ to $+20$ mA DC/0 to 100% (terminal [C1]) • UP/DOWN operation: Multi-frequency (16 steps), 16-bit parallel • Pulse train input (standard): Pulse input = [X7] terminal, Rotational direction = One of the digital input terminals except [X7] • Link operation: Various buses (option) • Reference frequency switching, Remote/local mode switching, Auxiliary frequency setting, Proportional operation setting, and Inverse operation 	
	Acceleration/deceleration time	0.00 to 6000 s Linear/S-curve/curvilinear, Acceleration/deceleration time settings 1 to 4 switchable	
	Stop control	<ul style="list-style-type: none"> • Running continued at the stop frequency, coast-to-stop, or force to stop. • DC braking: Braking starting frequency (up to 60 Hz), time (up to 30.0 s), and operation level (up to 100%) • Zero speed control (under vector control with speed sensor.) 	

	Item	Explanation
Control	Auto-restart after momentary power failure	<ul style="list-style-type: none"> • Trip immediately, trip after recovery from power failure, trip after deceleration to stop • Continue to run, restart at the frequency at which the power failure occurred, restart at the starting frequency, restart after searching for idling motor speed
	Hardware current limiter	<ul style="list-style-type: none"> • Current limiter operation level (20 to 200%) • Overcurrent limiting by hardware (This can be canceled.)
	Torque limiter	<ul style="list-style-type: none"> • Torque limit value ($\pm 300\%$) • Torque limiter 1/2, torque limiter enabled/disabled, analog torque limit value
	Control functions	<ul style="list-style-type: none"> • Analog input adjustment (gain/offset/filter time constant), frequency limiter (high and low), bias frequency, jump frequency, jogging operation, pre-excitation, switch to commercial power, commercial power switching sequence, cooling fan ON/OFF control, select motor 2 to 4, protect motor from dew condensation, universal DI, universal DO, universal AO, rotational direction limitation • Overload prevention control, auto search, slip compensation, automatic deceleration (anti-regenerative control), droop control, PID process control, PID dancer control, Deceleration characteristics (improving braking capability), auto energy saving function • Offline tuning • Life early warning, cumulative inverter run time, cumulative motor run time • Light alarm, retry, command loss detection
	Digital input	Run forward command, run reverse command, select multi-frequency, select ACC/DEC time, enable 3-wire operation, coast to a stop, reset alarm, enable external alarm trip, ready for jogging, select frequency command 2/1, select motor 1 to 4, enable DC braking, select torque limiter level, switch to commercial power, UP (increase output frequency), DOWN (decrease output frequency), enable data change with keypad, cancel PID control, switch normal/inverse operation, interlock, cancel torque control, enable communications link via RS-485 or fieldbus (option), universal DI, enable auto search for idling motor speed at starting, force to stop, pre-excitation, reset PID integral and differential components, hold PID integral component, select local (keypad) operation, protect the motor from dew condensation, enable internal sequence to commercial lines, pulse train input, pulse train sign, cancel constant peripheral speed control, hold the constant peripheral speed control frequency in the memory, switch to commercial power operation, select droop control, servo-lock command, cancel PG alarm, cancel customizable logic, clear all customizable logic timers
	Transistor output	Inverter running, frequency arrival signal 1/3, frequency detected (3 points), undervoltage detected (inverter stopped), torque polarity detected, inverter output limiting, auto-restarting after momentary power failure, motor overload early warning, keypad operation, inverter ready to run, switch motor power between commercial line and inverter output (inverter input/output/commercial power), select the AX terminal function (primary side MC), inverter output limiting with delay, cooling fan in operation, auto-resetting, universal DO, heat sink overheat early warning, service lifetime alarm, reference loss detected, inverter output on, overload prevention control, current detected (3 points), low level current detected, PID alarm, under PID control, PID control stopped due to slow flowrate, low output torque detected, torque detected (2 points), switched to motor 1 to 4, run forward signal, run reverse signal, inverter in remote operation, PTC status detection enabled, brake signal, analog frequency reference loss on the terminal [C1], inverter keeping speed output, speed arrived, PG error detected, maintenance timer, light alarm, alarm relay contact output (for any fault), braking resistor broken, positioning completion signal, enable circuit failure detected, customizable logic output signal
	Analog output	Terminals [FM1] and [FM2]: Output a selected signal with analog DC voltage (0 to +10 V) or analog DC current (4 to 20 mA) Selectable output signals: Output frequency (before slip compensation, after slip compensation), output current, output voltage, output torque, load factor, input power, PID feedback amount (PV), speed (PG feedback value), DC link bus voltage, universal AO, motor output, calibration, PID command (SV), PID output (MV)
Indication	Running/stopping	Speed monitor (reference frequency (Hz), output frequency, motor speed, load shaft speed, line speed, speed in %) Output current, output voltage, torque calculation value, input power, PID command value, PID feedback amount, PID output, load factor, motor output, torque current, flux command, analog signal input monitor, input watt-hour Life early warning, cumulative inverter run time, cumulative motor run time, input watt-hour, number of startups I/O checking, energy-saving monitor (input power, input power x coefficient (charges for input power))
	Trip mode	Trip history: Saves and displays the last 4 trip factors and their detailed description.
Other features	Communications	RS-485 COM port 1 (for keypad connection), RS-485 COM port 2 (on terminal board), and USB port (with optional keypad)
	Protection against momentary power failure	Upon detection of a momentary power failure lasting more than 15 ms, this function stops the inverter output. If restart after momentary power failure is selected, this function invokes a restart process if power is restored within a predetermined period (allowable momentary power failure time).

Characteristics

Model Variations

Keypad Functionality

Inverter PC Softw

Standard Specifications

Common Specifications

Basic Wiring Diagram

Terminal Functions

Function Settings

External Dimensions

Options

Reference material

Warranty

Basic Wiring Diagram

Wiring of main circuit terminal and grounding terminal

■ Basic wiring diagram

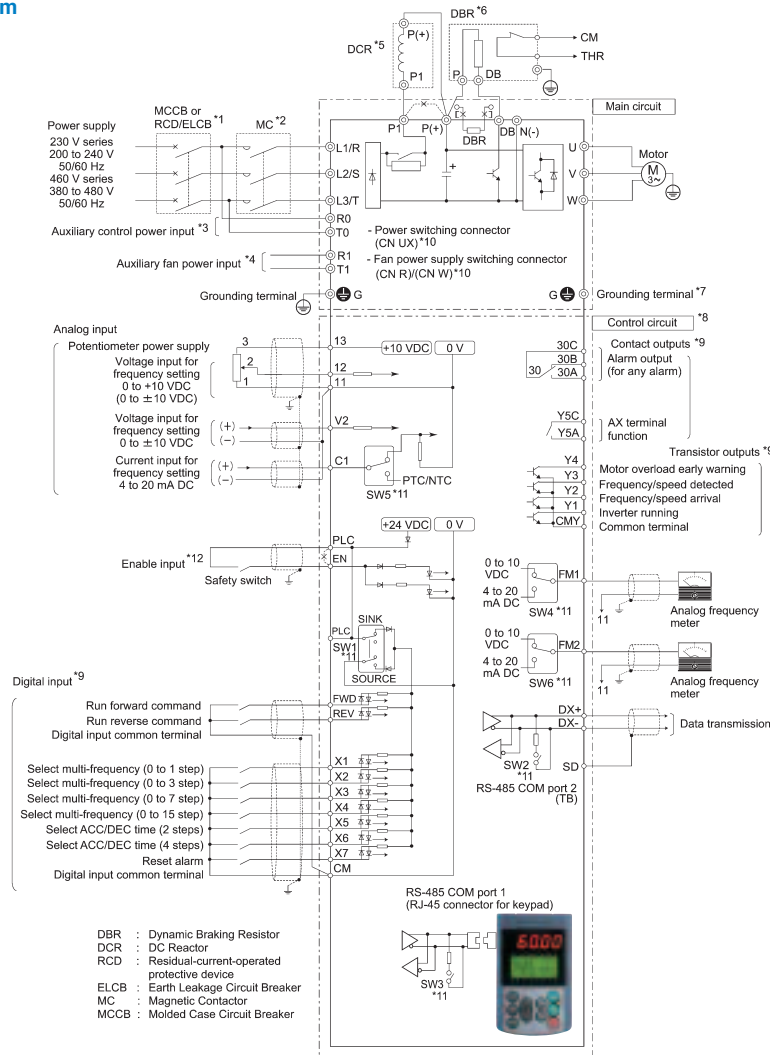

- *1 Install a recommended molded case circuit breaker (MCCB) or residual-current-operated protective device (RCD)/earth leakage circuit breaker (ELCB) (with overcurrent protection function) in the primary circuit of the inverter to protect wiring. Ensure that the circuit breaker capacity is equivalent to or lower than the recommended capacity.
- *2 Install a magnetic contactor (MC) for each inverter to separate the inverter from the power supply, apart from the MCCB or RCD/ELCB, when necessary. Connect a surge absorber in parallel when installing a coil such as the MC or solenoid near the inverter.
- *3 The R0 and T0 terminals are provided for inverters of 2 HP or above.
To retain an alarm output signal **ALM** issued on inverter's programmable output terminals by the protective function or to keep the keypad alive even if the main power has shut down, connect these terminals to the power supply lines. Without power supply to these terminals, the inverter can run.
- *4 Normally no need to be connected. Use these terminals when the inverter is equipped with a high power-factor, regenerative PWM converter (RHC series).
- *5 When connecting an optional DC reactor (DCR), remove the jumper bar from the terminals P1 and P(+).
The FRN100G1S-2/4U and higher types come with a DCR. Be sure to connect the DCR.
Use a DCR when the capacity of the power supply transformer exceeds 500 kVA and is 10 times or more the inverter rated capacity, or when there are thyristor-driven loads in the same power supply line.
The DCR built-in type has no DCR at this location.
- *6 Inverters of 15 HP or below have a built-in braking resistor (DBR) between the terminals P(+) and DB.
When connecting an external braking resistor (DBR), be sure to disconnect the built-in one.
- *7 A grounding terminal for a motor. Use this terminal if needed.
- *8 For control signal wires, use twisted or shielded-twisted wires. When using shielded-twisted wires, connect the shield of them to the common terminals of the control circuit. To prevent malfunction due to noise, keep the control circuit wiring away from the main circuit wiring as far as possible (recommended: 3.9 inches (10 cm) or more). Never install them in the same wire duct. When crossing the control circuit wiring with the main circuit wiring, set them at right angles.
- *9 The connection diagram shows factory default functions assigned to digital input terminals [X1] to [X7], [FWD] and [REV], transistor output terminals [Y1] to [Y4], and relay contact output terminals [Y5A/C] and [30A/B/C].
- *10 Switching connectors in the main circuits. For details, refer to "Switching connectors" later in this section.
- *11 Slide switches on the control printed circuit board (control PCB). Use these switches to customize the inverter operations. For details, refer to Section 2.3.6 "Setting up the slide switches."
- *12 When using the Enable input function, be sure to remove the jumper wire from terminals [EN] and [PLC]. For opening and closing the hardware circuit between terminals [EN] and [PLC], use safety components such as safety relays and safety switches that comply with EN954-1, Category 3 or higher. Be sure to use shielded wires exclusive to terminals [EN] and [PLC]. (Do not put them together with any other control signal wire in the same shielded core.) Ground the shielding layer. For details, refer to Chapter 9, Section 9.4 "Compliance with EN954-1, Category 3."
When not using the Enable input function, keep the terminals between [EN] and [PLC] short-circuited with the jumper wire (factory default).

Terminal Functions

Terminal Functions

Classification	Symbol	Name	Description	Remarks
Main circuit terminals	L1/R, L2/S, L3/T	Main circuit power inputs	Connect the three-phase input power lines.	Connect the single phase input to L1 & L3
	R0, T0	Auxiliary power input for the control circuit	Connect AC power lines.	
	R1,T1	Auxiliary power input for the fans	Normally, no need to use these terminals. Use these terminals for an auxiliary power input of the fans in a power system using a power regenerative PWM converter.	(200 V 50 HP or above) (400 V 100 HP or above)
	U,V,W	Inverter outputs	Connect a three-phase motor.	
	P(+),P1	DC reactor connection	Connect a DC reactor (DCR).	
	P(+),N(-)	DC link bus	Terminal for DC bus link system.	
	P(+),DB	Braking resistor	Connect an external braking resistor (option).	(30HP or below)
	⊕G	Grounding for inverter	Grounding terminals for the inverter.	
Analog input	[13]	Power supply for the potentiometer	Power supply (+10 VDC) for frequency command potentiometer (Variable resistor: 1 to 5kΩ) The potentiometer of 1/2 W rating or more should be connected. (10 VDC, 10 mADC max.)	
	[12]	Analog setting voltage input	<ul style="list-style-type: none"> External input voltage to be used as a frequency command. 0 to +10 VDC/ 0% to 100% (0 to +5 VDC/ 0% to 100%) 0 to ±10 VDC/ 0% to ±100% (0 to ±5 VDC/ 0% to ±100%) 	Input impedance: 22kΩ Maximum input ±15 VDC
		(Inverse operation)	• +10 to 0 VDC/ 0 to 100%	
		(PID control)	Used as PID command value or PID feedback signal.	Gain: 200%
		(Auxiliary frequency setting)	• Used as additional auxiliary setting to various frequency settings.	Offset: ±5%
		(Gain setting)	• Used as gain for the frequency command. 0% to 100% for 0 to 10 V	Setting filter: 5 s
		(Torque limit value)	• Analog torque limit value	
		(Torque command)	• Analog torque command value *6*7. 0 to 20mADC/0% to 100%	*8
	(Analog input monitor)	• Enables peripheral analog signals to be displayed on the keypad. (Display coefficient valid)		
	[C1]	Analog setting current input	<ul style="list-style-type: none"> External input voltage to be used as a frequency command. 4 to 20 mADC/ 0% to 100% 	Input impedance: 250Ω Maximum input 30 mADC
		(Inverse operation)	• 20 to 4 mADC/ 0% to 100%	
		(PID control)	Used as PID command value or PID feedback signal.	Gain: 200%
		(PTC/NTC thermistor connection)	• Connect a PTC/NTC thermistor for motor protection. (Switchable)	Offset: ±5%
		(Auxiliary frequency setting)	• Used as additional auxiliary setting to various frequency settings.	Setting filter: 5 s
		(Gain setting)	• Used as gain for the frequency command. 0% to 100% for 4 to 20 mA	
		(Torque limit value)	• Analog torque limit value	*8
	(Torque command)	• Analog torque command value *6*7		
	(Analog input monitor)	• Enables peripheral analog signals to be displayed on the keypad. (Display coefficient valid)		
	[V2]	Analog setting voltage input	<ul style="list-style-type: none"> External input voltage to be used as a frequency command. 0 to +10 VDC/ 0 to 100% (0 to +5 VDC/ 0 to 100%) 0 to ±10 VDC/ 0 to ±100% (0 to ±5 VDC/ 0 to ±100%) 	Input impedance: 22kΩ Maximum input ±15 VDC
		(Inverse operation)	• +10 to 0 VDC/ 0 to 100%	
		(PID control)	Used as PID command value or PID feedback signal.	Gain: 200%
		(Auxiliary frequency setting)	• Used as additional auxiliary setting to various frequency settings.	Offset: ±5%
		(Gain setting)	• Used as gain for the frequency command. 0% to 100% for 0 to 10 V	Setting filter: 5 ss
		(Torque limit value)	• Analog torque limit value	
(Torque command)		• Analog torque command value *6*7	*8	
(Analog input monitor)	• Enables peripheral analog signals to be displayed on the keypad. (Display coefficient valid)			
[11] (2 terminals)	Analog common	Common terminals for frequency command signals (12, 13, C1, V2, FM1,FM2).	These terminals are electrically isolated from terminals [CM]s and [CMY]s.	
Digital input	[X1]	Digital input 1	• The following functions can be assigned to terminals [X1] to [X7], [FWD], and [REV]. <Common functions>	Operation current at ON Source current: 2.5 to 5 mA Source current: 11 to 16 mA (terminal [X7]) Voltage level: 2 V
	[X2]	Digital input 2		
	[X3]	Digital input 3	• SINK/SOURCE is changeable by using the internal slide switch.	
	[X4]	Digital input 4	• These function codes may also switch the logic system between normal and negative to define how the inverter logic interprets either ON or OFF status of each terminal.	
	[X5]	Digital input 5		
	[X6]	Digital input 6	Terminal [X7] can receive a pulse rate input. (Using the SY disables [X7].)	
	[X7]	Digital input 7		
	[FWD]	Run forward commands	Operation current at OFF Allowable leakage current: 0.5 mA or less Voltage: 22 to 27 V	
	[REV]	Run reverse commands		
	[EN] (2 terminals)	Enable Input	• This terminal stops output transistor (making coast-to-stop) when the terminal EN-PLC is turned off. This terminal is dedicated for source input.	Source current at Turn-on : 5-10mA
	[CM]	Digital input common	Common terminals for digital input signals.	This terminal is electrically isolated from terminals [CM]s and [11]s.
	[PLC] (2 terminals)	PLC signal power	Connect to PLC output signal power supply. This terminal also serves as 24 V power supply.	+24 V (22 to 27 V), Max. 100 mA
	(FWD)	Run forward	Turning the (FWD) ON runs the motor in the forward direction; turning it OFF decelerates it to a stop.	These terminal commands can be assigned only to terminals [FWD] and [REV]. The negative logic system never applies to those terminals.
	(REV)	Run reverse	Turning the (REV) ON runs the motor in the reverse direction; turning it OFF decelerates it to a stop.	Same as above.
	(SS1)	Select multi-frequency	The combination of the ON/OFF states of digital input signals (SS1), (SS2), (SS4) and (SS8) provides 16 different frequency choices.	
	(SS2)			
	(SS4)			
(SS8)				
(RT1)	Select ACC/DEC time (2 steps)	The combination of the ON/OFF states of (RT1) and (RT2) provides four choices of acceleration/deceleration settings.		
(RT2)	Select ACC/DEC time (4 steps)			
(HLD)	Enable 3-wire operation	Used as a self-hold signal for 3-wire inverter operation. Turning the (HLD) ON self-holds the (FWD) or (REV) command; turning it OFF releases the self-holding.		

Terminal Functions

Terminal Functions

Classification	Symbol	Name	Description	Remarks
Digital input	(BX)	Coast to a stop	Turning the (BX) ON immediately shuts down the inverter output so that the motor coasts to a stop without issuing any alarms.	
	(RST)	Reset alarm	Turning the (RST) ON clears the alarm state.	Signal of 0.1 s or more
	(THR)	Enable external alarm trip	Turning the (THR) OFF immediately shuts down the inverter output so that the motor coasts to a stop, issuing OH2 if (ALM) is enabled.	
	(JOG)	Ready for jogging	Turning the (JOG) ON readies the inverter for jogging. Turning the (FWD) or (REV) ON starts jogging in the rotation direction specified by the jogging frequency.	
	(Hz2/Hz1)	Select frequency command 2/1	Turning the (Hz2/Hz1) ON selects Frequency command 2. (If the PID control is enabled, this terminal command switches the PID command.)	
	(M2)	Select motor 2	The combination of the ON/OFF states of (M2), (M3) and (M4) provides four choices of Motors 1 to 4. (Setting all of (M2), (M3) and (M4) OFF selects Motor 1.)	
	(M3)	Select motor 3		
	(M4)	Select motor 4		
	(DCBRK)	Enable DC braking	Turning the (DCBRK) ON activates DC braking.	
	(TL2/TL1)	Select torque limiter level	The (TL2/TL1) switches between torque limiters 1 and 2.	
	(SW50)	Switch to commercial power (50 Hz)	Turning the (SW50) OFF switches to commercial power, 50 Hz.*1~*3	
	(SW60)	Switch to commercial power (60 Hz)	Turning the (SW60) OFF switches to commercial power, 60 Hz.*1~*3	
	(UP)	UP (Increase output frequency)	While the (UP) is ON, the output frequency increases.	
	(DOWN)	DOWN (Decrease output frequency)	While the (UP) is ON, the output frequency decreases.	
	(WE-KP)	Enable data change with keypad	Only when the (WE-KP) is ON, function code data can be changed with the keypad.	
	(Hz/PID)	Cancel PID control	Turning the (Hz/PID) ON disables the PID control so that the inverter runs the motor with a reference frequency specified by any of the multi-frequency, keypad, analog input, etc.	
	(IVS)	Switch normal/inverse operation	The (INV) switches the output frequency control between normal (proportional to the input value) and inverse in PID process control and manual frequency command. Turning the (INV) ON selects the inverse operation.	
	(IL)	Interlock	In a configuration where a magnetic contactor (MC) is inserted between the inverter and motor, connecting the auxiliary contact to this terminal enables the input of the (IL) when a power failure occurs, activating the momentary power failure detection function	
	(HZ/TRQ)	Cancel torque control	Turning this signal on cancels torque control.	
	(LE)	Enable communications link via RS-485 or field bus	Turning the (LE) ON gives priority to commands received via the RS-485 communications link or the field bus option.	
	(U-DI)	Universal DI	Using the (U-DI) enables the inverter to monitor arbitrary digital input signals sent from the peripheral equipment, telling the signal status to the host controller.	
	(STM)	Enable auto search for idling motor speed at starting	The (STM) enables auto search for idling motor speed at the start of operation.	
	(STOP)	Force to stop	Turning the (STOP) OFF causes the motor to decelerate to a stop forcedly in accordance with the specified deceleration time.	
	(PID-RST)	Reset PID integral and differential components	Turning the (PID-RST) ON resets PID integral and differential components.	
	(PID-HLD)	Hold PID integral component	Turning this terminal command ON holds the integral components of the PID processor.	
	(EXITE)	Pre-excitation	When this (EXITE) signal comes ON, preliminary excitation starts.*6*7	
	(LOC)	Select local (keypad) operation	Turning the (LOC) ON gives priority to run/frequency commands entered from the keypad.	
	(DWP)	Protect motor from dew condensation	Turning the (DWP) ON supplies a DC current to the motor that is on halt, in order to generate heat, preventing dew condensation.	
	(ISW50)	Enable integrated sequence to switch to commercial power (50 Hz)	Turning the (ISW50) OFF switches inverter operation to commercial-power operation in accordance with the inverter internal switching sequence (for 50 Hz).	
	(ISW60)	Enable integrated sequence to switch to commercial power (60 Hz)	Turning the (ISW50) OFF switches inverter operation to commercial-power operation in accordance with the inverter internal switching sequence (for 60 Hz).	
	(PIN)	Pulse train input	Frequency command by pulse rate input.	Available only on terminal [X7] (E07)
	(SIGN)	Pulse train sign	Rotational direction command for pulse rate input. OFF: Forward, ON: Reverse	Available only on terminal [X7] (E07)
	(BATRY)	Enable battery operation	Turning this terminal on cancels the under voltage protection so that the inverter runs the motor with battery power in an undervoltage condition.	
(HZ/LSC)	Cancel constant peripheral speed control	Turning on this terminal cancels constant peripheral speed control.		
(LSC/HLD)	Hold the constant peripheral speed control frequency in memory	Turning on this terminal cancels constant peripheral speed control frequency in memory.		
(CRUN-M1)	Count the run time of commercial power-driven motor 1	Turning the (CRUN-M1) ON accumulates the run time of motor 1 in commercial-power operation. (independent of run/stop and motor selected)		
(CRUN-M2)	Count the run time of commercial power-driven motor 2	Turning the (CRUN-M2) ON accumulates the run time of motor 2 in commercial-power operation. (independent of run/stop and motor selected)		

Terminal Functions Cont'd

Classification	Symbol	Name	Description	Remarks
Digital Input	(CRUN-M3)	Count the run time of commercial power-driven motor 3	Turning the (CRUN-M3) ON accumulates the run time of motor 3 in commercial-power operation. (independent of run/stop and motor selected)	
	(CRUN-M4)	Count the run time of commercial power-driven motor 4	Turning the (CRUN-M4) ON accumulates the run time of motor 4 in commercial-power operation. (independent of run/stop and motor selected)	
	(DROOP)	Select droop control	Turning the(DROOP) ON enables the droop control.	
	(PG-CCL)	Cancel PG alarm	Turning the(PG-CCL) ON cancels PG alarm.*4*5*7	
	(CLC)	Cancel customizable logic	Turning this terminal on cancels customizable logic.	
	(CLTC)	Clear all customizable logic timers	Turning this terminal on cancels all customizable logic timers.	
	(LOCK)	Servo-lock command	Turning the(LOCK) ON enables the servo-lock control.*7	
	(NONE)	No function	No function assigned. Can be used as a temporary input of the customized logic interface.	

Classification	Symbol	Name	Description	Remarks
Transistor output	(PLC)	Transistor output power	Transistor output load power. (24 VDC, 100 mA DC max.) (Note: Shared by the digital input PLC terminal.)	Short-circuit terminals [CM] and [CMY].
	[Y1]	Transistor output 1	Out of the following signals, the selected one will be issued. • These function codes may also switch the logic system between normal and negative to define how the inverter logic interprets either ON or OFF status of each terminal. Applicable to SINK and SOURCE. (No switching is required.)	Maximum voltage 27 VDC Maximum current 50 mADC
	[Y2]	Transistor output 2		Leakage current 0.1 mA or less ON voltage: Max. 2V (50 mA)
	[Y3]	Transistor output 3		
	[Y4]	Transistor output 4		
	[CMY]	Transistor output common	Common terminal for transistor output signal terminals.	This terminal is electrically isolated from terminals [CM]s and [1]s.
	(RUN)	Inverter running	This signal is ON when the inverter is running with the starting frequency or higher.	
	(RUN2)	Inverter output on	This signal is ON when the inverter is running with the starting frequency or higher or when the DC braking is activated.	
	(DNZS)	Speed valid	This signal is turned ON when the speed command/actual speed exceeds the stop frequency; it is turned OFF when it is below the stop frequency. (Speed command and actual speed selectable.)	
	(FRUN)	Running forward	ON-signal is generated at forward rotation.	
	(RRUN)	Running reverse	ON-signal is generated at reverse rotation	
	(FAR)	Frequency (speed) arrival signal	ON-signal is generated when frequency / speed reaches at set-value.	
	(FAR3)	Frequency (speed) arrival signal 3	ON-signal is generated when frequency / speed reaches at set-value. When the run command is OFF, the frequency command is interpreted as zero and frequency arrival is judged under the premise. This output signal comes ON when the output frequency exceeds the frequency detection level, and it goes OFF when the output frequency drops below the "Frequency detection level - Hysteresis width."	
	(FDT)	Frequency (speed) detected		
	(FDT2)	Frequency (speed) detected 2		
	(FDT3)	Frequency (speed) detected 3		
	(LU)	Undervoltage detected	This signal is ON when the undervoltage protection function is activated so that the motor is in an abnormal stop state.	
	(B/D)	(Inverter stopped) Torque polarity detected	This signal comes ON when the inverter is driving the motor; it comes OFF when the inverter is braking the motor or on halt.	
	(IOL)	Inverter output limiting	This signal comes ON when the inverter is activating the current limiter, torque limiter, or anti-regenerative control (automatic deceleration).	
	(IOL2)	Inverter output limiting with delay	This signal comes ON when the inverter has been activated the current limiter, torque limiter, or anti-regenerative control (automatic deceleration) for at least 20 ms.	
	(IPF)	Auto-restarting after momentary power failure	This signal is kept ON during the period from when the inverter shuts down its output due to a momentary power failure until the restart is completed.	
	(OL)	Motor overload early warning	This signal comes ON when the value calculated by the electronic thermal overload protection exceeds the predetermined detection level. (applicable to Motor 1 only)	
	(KP)	Keypad operation enabled	This signal is ON when the inverter is in keypad operation.	
	(RDY)	Inverter ready to run	This signal comes ON when the inverter is ready to run.	
	(SW88)	Switch motor drive source between commercial power and inverter output (For MC on commercial line)	This controls the magnetic contactor located at the commercial power line side, for switching the motor drive source from the commercial power line to inverter output.	
	(SW52-2)	Switch motor drive source between commercial power and inverter output (For secondary side)	This controls the magnetic contactor located at the inverter output side (secondary side), for switching the motor drive source from the commercial power line to inverter output.	
	(SW52-1)	Switch motor drive source between commercial power and inverter output (For primary side)	This controls the magnetic contactor located at the inverter input side (primary side), for switching the motor drive source from the commercial power line to inverter output.	
	(SWM1)	Motor 1 selected	This signal comes ON when motor 1 is selected.	
	(SWM2)	Motor 2 selected	This signal comes ON when motor 2 is selected.	
	(SWM3)	Motor 3 selected	This signal comes ON when motor 3 is selected.	
	(SWM4)	Motor 4 selected	This signal comes ON when motor 4 is selected.	
	(AX)	Select AX terminal function (For MC on primary side)	This signal controls the magnetic contactor located at the inverter input side (primary side).	
(FAN)	Cooling fan in operation	This signal tells the ON/OFF state of the cooling fan.		
(TRY)	Auto-resetting	This output signal comes ON when auto-resetting is in progress.		

Terminal Functions

Terminal Functions

Classification	Symbol	Name	Description	Remarks
Transistor output	(U-DO)	Universal DO	This signal commands a peripheral apparatus according to signal sent from the host controller.	
	(ID)	Current detected	This signal comes ON when the output current of the inverter has exceeded the detection level for the time longer than the specified timer period.	
	(ID2)	Current detected 2		
	(ID3)	Current detected 3		
	(TD1)	Torque detected 1	This signal comes ON when the output torque of the inverter has exceeded the detection level for the time longer than the specified timer period.	
	(TD2)	Torque detected 2		
	(OH)	Heat sink overheat early warning	This outputs a heat sink overheat early warning before an overheat trip actually happens. It is also used to detect an internal air circulation fan failure. (Applicable to inverters with 45kW or above for 200V class series or 75 kW or above for 400V class series)	
	(LIFE)	Lifetime alarm	This outputs a service lifetime alarm according to the internal lifetime criteria. It is also used to detect an internal air circulation fan failure. (Applicable to inverters with 45kW or above for 200V class series or 75 kW or above for 400V class series)	
	(PID-ALM)	PID alarm	This outputs an absolute-value alarm and deviation alarm when the PID control is enabled.	
	(PID-CTL)	Under PID control	This signal comes ON when the PID control is enabled.	
	(PID-STP)	Motor stopped due to slow flowrate under PID control	This signal is ON when the inverter is in a stopped state by the slow flowrate stopping function under the PID control. (The inverter is stopped even if a run command is entered.)	
	(REF OFF)	Reference loss detected	This signal comes ON when an analog frequency command is missed due to wire breaks.	
	(IDL)	Low current detected	This signal comes ON when the current has been below the preset current detection level for the time longer than the specified timer period.	
	(U-TL)	Low output torque detected	This signal comes ON when the torque value has been below the preset detection level for the time longer than the specified timer period.	
	(OLP)	Overload prevention control	This output signal comes ON when the overload prevention control is activated.	
	(RMT)	In remote operation	This signal comes ON when the inverter is in the remote mode.	
	(BRKS)	Brake signal	Signal for Brake Control. Turn ON when the brake is released.	
	(MNT)	Maintenance timer	Alarm signal is generated when time passes or start-up exceeds over the preset value	
	(THM)	Motor overheat detected by thermistor	This signal comes ON when the motor overheat is detected with the PTC/NTC thermistor.	
	(C1OFF)	Terminal [C1] wire break	When Input current to C1 terminal become less than 2mA, this is interpreted as wire brake and then ON-signal is generated.	
	(DSAG)	Speed agreement	This output signal comes ON when the difference between the detected speed and the commanded speed (frequency) has been within the specified range for the time specified by the agreement timer.	
	(PG-ERR)	PG error detected	Speed Deflection is greater than the certain value, ON-signal is generated.	
	(DECF)	Enable circuit failure detected	This signal comes ON when the circuit detecting the status of [EN] terminal is defective. (at single failure)	
	(ENOFF)	Enable input OFF	On-signal is generated when Enable input is turned off.	
	(DBAL)	Braking transistor broken	This signal comes ON when the DBTr defective is detected.	
	(PSET)	Positioning completion signal	This signal comes ON when the inverter has been servo-locked so that the motor is held within the positioning completion range.	
	(L-ALM)	Light alarm	When Alarm or warning, which is set as "light failure", is generated, inverter indicates "Light failure" on the display and generates this light failure signal.	
	(ALM)	Alarm output (for any alarm)	This is an alarm relay output as a transistor output.	
	(CL01)	Customizable logic output signal 1	Turns on when customizable logic output signal 1 is in operation.	
	(CL02)	Customizable logic output signal 2	Turns on when customizable logic output signal 2 is in operation.	
	(CL03)	Customizable logic output signal 3	Turns on when customizable logic output signal 3 is in operation.	
	(CL04)	Customizable logic output signal 4	Turns on when customizable logic output signal 4 is in operation.	
	(CL05)	Customizable logic output signal 5	Turns on when customizable logic output signal 5 is in operation.	
Relay output	[Y5A], [Y5C]	General purpose relay output	• As a general-purpose relay output, the same functions as Y1 to Y4 can be assigned. • The logic value is switchable between "[Y5A] and [Y5C] are excited" and "non-excited."	Contact rating: 250 VAC, 0.3 A $\cos\phi=0,3$
	[30A], [30B], [30C]	Alarm relay output (for any error)	• This outputs a non-voltage contact signal (1c) when the inverter is stopped with the protective function. • As a general-purpose relay output, the same functions as Y1 to Y4 can be assigned. • The logic value is switchable between "[Y5A] and [Y5C] are excited" and "non-excited."	48 VDC, 0.5A
Analog output	[FM1] [FM2]	Analog monitor 1 Analog monitor 2	The output can be either analog DC voltage (0 to 10 V) or analog DC current (4 to 20 mA). Any one of the following items can be output with the selected analog form. • Output frequency (before slip compensation, after slip compensation) • Output current • Output voltage • Output torque • Load factor • Input power • PID feedback amount • DC link bus voltage • PID command • PID output • Speed detection (PG feedback value) • Universal AO • Motor output • Analog output test *When the terminal is outputting 0 to 10 VDC, it is capable of driving up to two meters with 10kΩ impedance. *When the terminal is outputting current, it is capable of connecting a maximum of 500Ω to the meter. Adjustable gain range: 0% to 300%	
	[11]	Analog common		
Communication	RJ-45 connector for the keypad	RS-485 communications port 1	Out of the following protocols, the desired one can be selected. • Modbus RTU • Fuji general-purpose inverter protocol • FRENIC Loader protocol (SX)	With power supply to the keypad
	[DX+]/[DX-]/[SD]	RS-485 communications port 2 (Terminals on control PCB)	• Modbus RTU • Fuji general-purpose inverter protocol	
	USB port	USB port (with optional keypad)	A USB port connector (Mini-B) that connects an inverter to a personal computer. FRENIC Loader.	Mounted on Remote Keypad (option)

*1 Effective function in V/f control

*2 Effective function in dynamic torque vector control

*3 Effective function when the slip compensation is made active under V/f control

*4 Effective function under the V/f control with speed sensor (PG option is necessary.)

*5 Effective function in dynamic torque vector control with speed sensor. (PG option is necessary.)

*6 Effective function in vector control without speed sensor

*7 Effective function in vector control with speed sensor (PG option is necessary.)

*8 Function not incorporated in the inverters of initial version

Terminal Arrangement

Main circuit terminals

Inverter type		Refer to:
Three-phase 230 V	Three-phase 460 V	
FRNF50G1S-2U	FRNF50G1S-4U	Figure A
FRN001G1S-2U	FRN001G1S-4U	
FRN002G1S-2U	FRN002G1S-4U	Figure B
FRN003G1S-2U	FRN003G1S-4U	
FRN005G1S-2U	FRN005G1S-4U	Figure C
FRN007G1S-2U	FRN007G1S-4U	
FRN010G1S-2U	FRN010G1S-4U	Figure D
FRN015G1S-2U	FRN015G1S-4U	
FRN020G1S-2U	FRN020G1S-4U	Figure E
FRN025G1S-2U	FRN025G1S-4U	
FRN030G1S-2U	FRN030G1S-4U	Figure F
FRN040G1S-2U	FRN040G1S-4U	
FRN050G1S-2U	FRN050G1S-4U	Figure G
	FRN060G1S-4U	
	FRN075G1S-4U	
	FRN100G1S-4U	
FRN060G1S-2U	FRN125G1S-4U	Figure H
FRN075G1S-2U		
FRN100G1S-2U	FRN150G1S-4U	Figure I
—		
—	FRN200G1S-4U	Figure J
FRN125G1S-2U	—	Figure K
—	FRN250G1S-4U	Figure L
—	FRN300G1S-4U	Figure M
FRN150G1S-2U	FRN350G1S-4U	Figure N
—	FRN450G1S-4U	
—	FRN500G1S-4U	Figure O
—	FRN600G1S-4U	
—	FRN700G1S-4U	Figure P
—	FRN800G1S-4U	
—	FRN900G1S-4U	Figure Q
—	FRN1000G1S-4U	

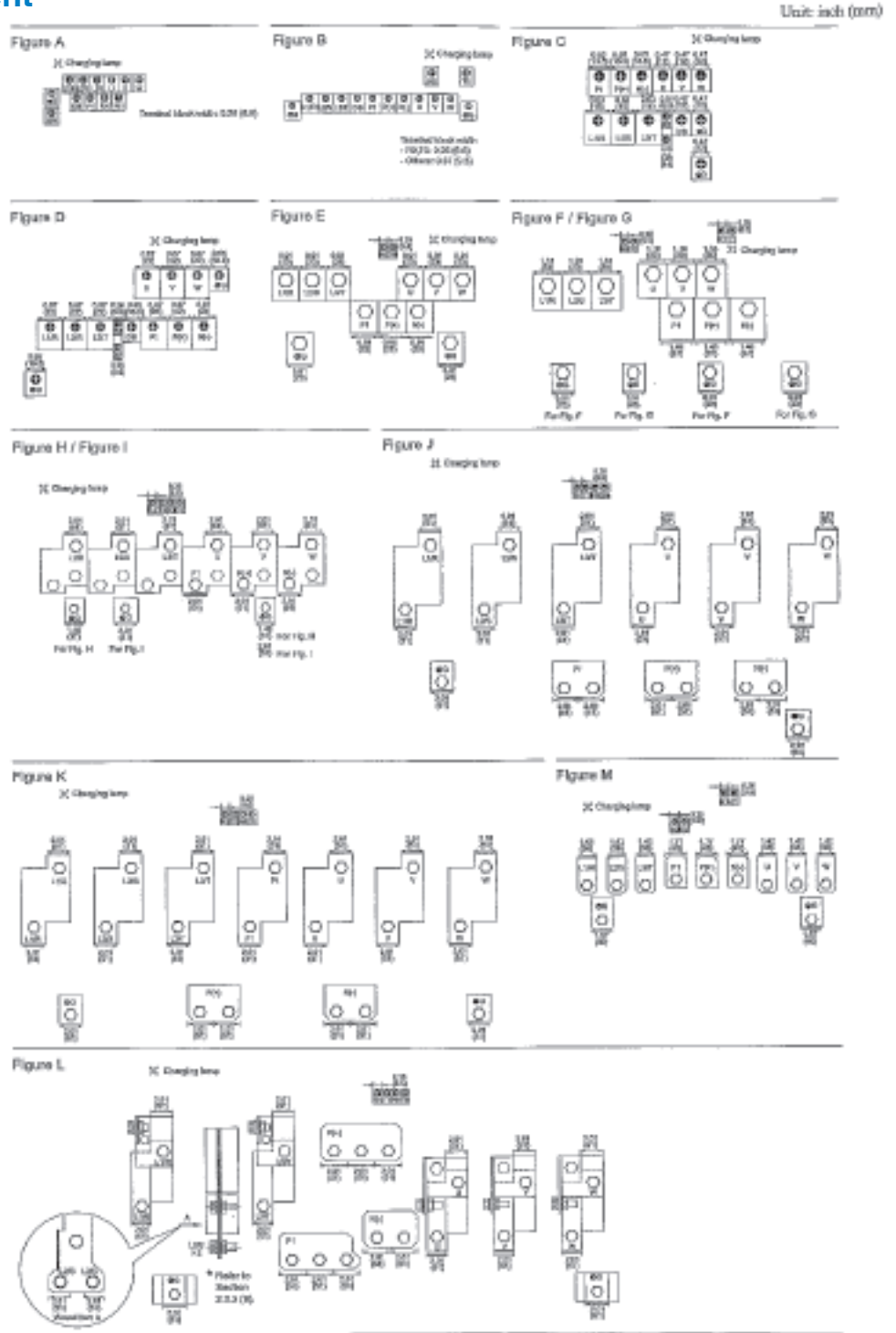

Arrangement of control circuit terminals (common to all inverter types)

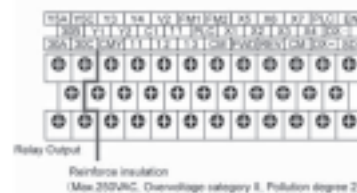

Screw size: M3, Tightening torque: 6.2 lb-in (0.7 N·m)
Recommended wire size: AWG 19 or 18 (0.7 to 0.8 mm²)*

* Using wires exceeding the recommended sizes may lift the front cover depending upon the number of wires used, impeding keypad's normal operation.

Function Settings

Function Settings

F codes: Fundamental Functions

Code	Name	Data setting range	Change when running	Data copying	Default setting	Drive control				
						V/f	PG V/f	w/o PG	w/ PG	Torque Control
F00	Data Protection	0 : Disable both data protection and digital reference protection 1 : Enable data protection and disable digital reference protection 2 : Disable data protection and enable digital reference protection 3 : Enable both data protection and digital reference protection	Y	Y	0	Y	-	Y	Y	-
F01	Frequency Command 1	0 : / keys on keypad 1 : Voltage input to terminal [12] (-10 to +10 VDC) 2 : Current input to terminal [C1] (4 to 20 mA DC) 3 : Sum of voltage and current inputs to terminals [12] and [C1] 5 : Voltage input to terminal [V2] (-10 to +10 VDC) 7 : Terminal command UP/DOWN control 8 : / keys on keypad (balanceless-bumpless switching available) 11 : Digital input interface card (option) 12 : Pulse train input	N	Y	0	Y	-	Y	Y	-
F02	Operation Method	0 : Keypad 1 : Terminal command <i>FWD</i> or <i>REV</i> 2 : Keypad (Forward direction) 3 : Keypad (Reverse direction)	N	Y	0	Y	-	Y	Y	-
F03	Maximum Frequency 1	25.0 to 500.0 Hz	N	Y	60.0	Y	-	Y	Y	-
F04	Base Frequency 1	25.0 to 500.0 Hz	N	Y	60.0	Y	-	Y	Y	-
F05	Rated Voltage at Base Frequency 1	0 : Output a voltage in proportion to input voltage 80 to 240 V : Output an AVR-controlled voltage (for 230 V series) 160 to 500 V : Output an AVR-controlled voltage (for 460 V series)	N	Y2	230 460	Y	-	Y	Y	-
F06	Maximum Output Voltage 1	80 to 240 V : Output an AVR-controlled voltage (for 230 V series) 160 to 500 V : Output an AVR-controlled voltage (for 460 V series)	N	Y2	230 460	Y	-	N	N	-
F07	Acceleration Time 1	0.00 to 6000 s	Y	Y	*1	Y	-	Y	Y	-
F08	Deceleration Time 1	Note: Entering 0.00 cancels the acceleration time, requiring external soft-start.	Y	Y	*1	Y	-	Y	Y	-
F09	Torque Boost 1	0.0% to 20.0% (percentage with respect to "Rated Voltage at Base Frequency 1")	Y	Y	0.0	Y	-	N	N	-
F10	Electronic Thermal Overload Protection for Motor 1 (Select motor characteristics)	1 : For a general-purpose motor with shaft-driven cooling fan 2 : For an inverter-driven motor, non-ventilated motor, or motor with separately powered cooling fan	Y	Y	1	Y	-	Y	Y	-
F11	(Overload detection level)	0.00: Disable 1% to 135% of the rated current (allowable continuous drive current) of the motor	Y	Y1 Y2	*2	Y	-	Y	Y	-
F12	(Thermal time constant)	0.5 to 75.0 min	Y	Y	*3	Y	-	Y	Y	-
F14	Restart Mode after Momentary Power Failure (Mode selection)	0 : Trip immediately 1 : Trip after a recovery from power failure 2 : Trip after decelerate-to-stop 3 : Continue to run, for heavy inertia or general loads 4 : Restart at the frequency at which the power failure occurred, for general loads 5 : Restart at the starting frequency	Y	Y	0	Y	-	Y	Y	-
F15	Frequency Limiter (High)	0.0 to 500.0 Hz	Y	Y	70.0	Y	-	Y	Y	-
F16	(Low)	0.0 to 500.0 Hz	Y	Y	0.0	Y	-	Y	Y	-
F18	Bias (Frequency command 1)	-100.00% to 100.00%	Y*	Y	0.00	Y	-	Y	Y	-
F20	DC Braking 1 (Braking starting frequency)	0.0 to 60.0 Hz	Y	Y	0.0	Y	-	Y	Y	-
F21	(Braking level)	0% to 80% (LD/MD mode) *4, 0% to 100% (HD mode)	Y	Y	0	Y	-	Y	Y	-
F22	(Braking time)	0.00 (Disable); 0.01 to 30.00 s	Y	Y	0.00	Y	-	Y	Y	-
F23	Starting Frequency 1	0.0 to 60.0 Hz	Y	Y	0.5	Y	-	Y	Y	-
F24	(Holding time)	0.00 to 10.00 s	Y	Y	0.00	Y	-	Y	Y	-
F25	Stop Frequency	0.0 to 60.0 Hz	Y	Y	0.2	Y	-	Y	Y	-
F26	Motor Sound (Carrier frequency)	0.75 to 16 kHz (LD-mode inverters of 0.5 to 30 HP and HD-mode ones of 0.5 to 100 HP) 0.75 to 10 kHz (LD-mode inverters of 40 to 100 HP and HD-mode ones of 125 to 800 HP) 0.75 to 6 kHz (LD-mode inverters of 125 to 900 HP and HD-mode ones of 900 and 1000 HP) 0.75 to 4 kHz (LD-mode inverters of 1000 HP) 0.75 to 2 kHz (MD-mode inverters of 150 to 800 HP)	Y	Y	2	Y	-	Y	Y	-
F27	(Tone)	0 : Level 0 (Inactive) 1 : Level 1 2 : Level 2 3 : Level 3	Y	Y	0	Y	-	N	N	-
F29	Analog Output [FM1] (Mode selection)	0 : Output in voltage (0 to 10 VDC) 1 : Output in current (4 to 20 mA DC) 2 : Output in current (0 to 20 mA DC)	Y	Y	0	Y	Y	Y	Y	Y
F30	(Voltage adjustment)	0% to 300%	Y*	Y	100	Y	Y	Y	Y	Y
F31	(Function)	Select a function to be monitored from the followings. 0 : Output frequency 1 (before slip compensation) 1 : Output frequency 2 (after slip compensation) 2 : Output current 3 : Output voltage 4 : Output torque 5 : Load factor 6 : Input power 7 : PID feedback amount (PV) 8 : PG feedback value 9 : DC link bus voltage 10 : Universal AO 13 : Motor output 14 : Calibration (+) 15 : PID command (SV) 16 : PID output (MV) 17 : Positional deviation in synchronous operation	Y	Y	0	Y	Y	Y	Y	Y
F32	Analog Output [FM2] (Mode selection)	0 : Output in voltage (0 to 10 VDC) 1 : Output in current (4 to 20 mA DC) 2 : Output in current (0 to 20 mA DC)	Y	Y	0	Y	Y	Y	Y	N
F34	(Voltage adjustment)	0% to 300%	Y*	Y	100	Y	-	Y	Y	-
F35	Pulse Output [FMP] (Mode selection)	Select a function to be monitored from the followings. 0 : Output frequency 1 (before slip compensation) 1 : Output frequency 2 (after slip compensation) 2 : Output current	Y	Y	0	N	Y	N	Y	Y

● F codes: Fundamental Functions

Code	Name	Data setting range	Change when running	Data copying	Default setting	Drive control				
						V/f	PG V/f	w/o PG	w/ PG	Torque Control
F35	Analog Output [FM2] (Function)	3 : Output voltage 4 : Output torque 5 : Load factor 6 : Input power 7 : PID feedback amount (PV) 8 : PG feedback value 9 : DC link bus voltage 10 : Universal AO 13 : Motor output 14 : Calibration (+) 15 : PID command (SV) 16 : PID output (MV) 17 : Positional deviation in synchronous running	Y	Y	0	Y	Y	Y	Y	N
F37	Load Selection/ Auto Torque Boost/ Auto Energy Saving Operation 1	0 : Variable torque load 1 : Constant torque load 2 : Auto torque boost 3 : Auto energy saving (Variable torque load during ACC/DEC) 4 : Auto energy saving (Constant torque load during ACC/DEC) 5 : Auto energy saving (Auto torque boost during ACC/DEC)	N	Y	1	Y	-	N	Y	-
F38	Stop Frequency (Detection mode)	0 : Detected speed 1 : Reference speed	N	Y	0	N	-	N	Y	-
F39	(Holding Time)	0.00 to 10.00 s	Y	Y	0.00	Y	-	Y	Y	-
F40	Torque Limiter 1-1	-300% to 300%; 999 (Disable)	Y	Y	999	Y	-	Y	Y	-
F41	1-2	-300% to 300%; 999 (Disable)	Y	Y	999	Y	-	Y	Y	-
F42	Drive Control Selection 1	0 : V/f control with slip compensation inactive 1 : Dynamic torque vector control 2 : V/f control with slip compensation active 3 : V/f control with speed sensor 4 : Dynamic torque vector control with speed sensor 5 : Vector control without speed sensor 6 : Vector control with speed sensor	N	Y	0	Y	-	Y	Y	-
F43	Current Limiter (Mode selection)	0 : Disable (No current limiter works.) 1 : Enable at constant speed (Disable during ACC/DEC) 2 : Enable during ACC/constant speed operation	Y	Y	2	Y	-	N	N	-
F44	(Level)	20% to 200% (The data is interpreted as the rated output current of the inverter for 100%.)	Y	Y	*5	Y	-	N	N	-
F50	Electronic Thermal Overload Protection for Braking Resistor (Discharging capability)	0 (Braking resistor built-in type), 1 to 9000 kW, OFF (Disable)	Y	Y1 Y2	*6	Y	-	Y	Y	-
F51	(Allowable average loss)	0.001 to 99.99 kW	Y	Y1 Y2	0.001	Y	-	Y	Y	-
F52	(Resistance)	0.01 to 999Ω	Y	Y1 Y2	0.01	Y	-	Y	Y	-
F80	Switching between LD, MD and HD drive modes	0 : HD (High Duty) mode 1 : LD (Low Duty) mode 2 : MD (Medium Duty) mode	N	Y	1	Y	-	Y	Y	-

The shaded function codes () are applicable to the quick setup.

*1 6.00 s for inverters of 40 HP or below; 20.00 s for those of 50 HP or above

*2 The motor rated current is automatically set. See Table B (P03/A17/b17/r17).

*3 5.0 min for inverters of 40 HP or below; 10.0 min for those of 50 HP or above

*4 0% to 100% for inverters of 7.5 HP or below

*5 160% for inverters of 7.5 HP or below; 130% for those of 10 HP or above

*6 0 for inverters of 15 HP or below; OFF for those of 20 HP or above

● E codes: Extension Terminal Functions

Code	Name	Data setting range	Change when running	Data copying	Default setting	Drive control				
						V/f	PG V/f	w/o PG	w/ PG	Torque Control
		Selecting function code data assigns the corresponding function to terminals [X1] to [X7] as listed below.								
E01	Terminal [X1] Function	0 (1000) : Select multi-frequency. (0 to 1 steps) (SS1)	N	Y	0	Y	Y	Y	Y	N
E02	Terminal [X2] Function	1 (1001) : Select multi-frequency. (0 to 3 steps) (SS2)	N	Y	1	Y	Y	Y	Y	N
E03	Terminal [X3] Function	2 (1002) : Select multi-frequency. (0 to 7 steps) (SS4)	N	Y	2	Y	Y	Y	Y	N
E04	Terminal [X4] Function	3 (1003) : Select multi-frequency. (0 to 15 steps) (SS8)	N	Y	3	Y	Y	Y	Y	N
E05	Terminal [X5] Function	4 (1004) : Select ACC/DEC time (2 steps) (RT1)	N	Y	4	Y	Y	Y	Y	N
E06	Terminal [X6] Function	5 (1005) : Select ACC/DEC time (4 steps) (RT2)	N	Y	5	Y	Y	Y	Y	N
E07	Terminal [X7] Function	6 (1006) : Enable 3-wire operation (HLD)	N	Y	8	Y	Y	Y	Y	Y
		7 (1007) : Coast to a stop (BX)				Y	Y	Y	Y	Y
		8 (1008) : Reset alarm (RST)				Y	Y	Y	Y	Y
		9 (1009) : Enable external alarm trip (9 = Active OFF, 1009 = Active ON) (THR)				Y	Y	Y	Y	Y
		10 (1010) : Ready for jogging (JOG)				Y	Y	Y	Y	N
		11 (1011) : Select frequency command 2/1 (Hz2/Hz1)				Y	Y	Y	Y	N
		12 (1012) : Select motor 2 (M2)				Y	Y	Y	Y	Y
		13 : Enable DC braking (DCBRK)				Y	Y	Y	Y	N
		14 (1014) : Select torque limiter level 2/1 (TL2/TL1)				Y	Y	Y	Y	Y
		15 : Switch to commercial power (50 Hz) (SW50)				Y	Y	N	N	N
		16 : Switch to commercial power (60 Hz) (SW60)				Y	Y	N	N	N
		17 (1017) : UP (Increase output frequency) (UP)				Y	Y	Y	Y	N
		18 (1018) : DOWN (Decrease output frequency) (DOWN)				Y	Y	Y	Y	N
		19 (1019) : Enable data change with keypad (WE-KP)				Y	Y	Y	Y	Y
		20 (1020) : Cancel PID control (Hz/PID)				Y	Y	Y	Y	N
		21 (1021) : Switch normal/inverse operation (IVS)				Y	Y	Y	Y	N
		22 (1022) : Interlock (IL)				Y	Y	Y	Y	Y
		23 (1023) : Cancel torque control (Hz/TRQ)				N	N	N	N	Y
		24 (1024) : Enable communications link via RS-485 or fieldbus (option) (LE)				Y	Y	Y	Y	Y
		25 (1025) : Universal DI (U-DI)				Y	Y	Y	Y	Y
		26 (1026) : Enable auto search for idling motor speed at starting (STM)				Y	Y	Y	N	Y
		30 (1030) : Force to stop (30 = Active OFF, 1030 = Active ON) (STOP)				Y	Y	Y	Y	Y
		32 (1032) : Pre-excitation (EXITE)				N	N	Y	Y	N
		33 (1033) : Reset PID integral and differential components (PID-RST)				Y	Y	Y	Y	N

*1 6.00 s for inverters of 40 HP or below; 20.00 s for those of 50 HP or above

*2 The motor rated current is automatically set. See Table B (P03/A17/b17/r17).

Function Settings

Function Settings

E codes: Extension Terminal Functions

Code	Name	Data setting range	Change when running	Data copying	Default setting	Drive control				
						V/f	PG V/f	w/o PG	w/ PG	Torque Control
E07	Terminal [X7] Function	34 (1034) : Hold PID integral component (PID-HLD)				Y	Y	Y	Y	N
		35 (1035) : Select local (keypad) operation (LOC)				Y	Y	Y	Y	Y
		36 (1036) : Select motor 3 (M3)				Y	Y	Y	Y	Y
		37 (1037) : Select motor 4 (M4)				Y	Y	Y	Y	Y
		39 : Protect motor from dew condensation (DWP)				Y	Y	Y	Y	Y
		40 : Enable integrated sequence to switch to commercial power (50 Hz) (ISW50)				Y	Y	N	N	N
		41 : Enable integrated sequence to switch to commercial power (60 Hz) (ISW60)				Y	Y	N	N	N
		47 (1047) : Servo-lock command (LOCK)				N	N	N	Y	N
		48 : Pulse train input (available only on terminal [X7] (E07)) (PIN)				Y	Y	Y	Y	Y
		49 (1049) : Pulse train sign (available on terminals except [X7] (E01 to E06)) (SIGN)				Y	Y	Y	Y	Y
		59 (1059) : Enable battery operation (BATRY)	N	Y	98	Y	Y	Y	Y	Y
		70 (1070) : Cancel constant peripheral speed control (Hz/LSC)				Y	Y	Y	Y	N
		71 (1071) : Hold the constant peripheral speed control frequency in the memory (LSC-HLD)				Y	Y	Y	Y	N
		72 (1072) : Count the run time of commercial power-driven motor 1 (CRUN-M1)				Y	Y	N	N	Y
		73 (1073) : Count the run time of commercial power-driven motor 2 (CRUN-M2)				Y	Y	N	N	Y
		74 (1074) : Count the run time of commercial power-driven motor 3 (CRUN-M3)				Y	Y	N	N	Y
		75 (1075) : Count the run time of commercial power-driven motor 4 (CRUN-M4)				Y	Y	N	N	Y
		76 (1076) : Select droop control (DROOP)				Y	Y	Y	Y	Y
		77 (1077) : Cancel PG alarm (PG-CCL)				N	Y	N	Y	N
		80 (1080) : Cancel customizable logic (CLC)				Y	Y	Y	Y	Y
		81 (1081) : Clear all customizable logic timers (CLTC)				Y	Y	Y	Y	Y
100 : No function assigned (NONE)				Y	Y	Y	Y	Y		
110 (1110) : Servo lock gain selection (SLG2)	N	Y	99	N	N	N	Y	N		
111 (1111) : Force to stop only by terminal (STOP-T)				Y	Y	Y	Y	Y		
Setting the value in parentheses () shown above assigns a negative logic input to a terminal.										
E10	Acceleration Time 2	0.00 to 6000 s	Y	Y	*1	Y	Y	Y	Y	N
E11	Deceleration Time 2	Note: Entering 0.00 cancels the acceleration time, requiring external soft-start and -stop.	Y	Y	*1	Y	Y	Y	Y	N
E12	Acceleration Time 3		Y	Y	*1	Y	Y	Y	Y	N
E13	Deceleration Time 3		Y	Y	*1	Y	Y	Y	Y	N
E14	Acceleration Time 4		Y	Y	*1	Y	Y	Y	Y	N
E15	Deceleration Time 4		Y	Y	*1	Y	Y	Y	Y	N
E16	Torque Limiter 2-1		-300% to 300%; 999 (Disable)	Y	Y	999	Y	Y	Y	Y
E17	Torque Limiter 2-2	-300% to 300%; 999 (Disable)	Y	Y	999	Y	Y	Y	Y	Y
Selecting function code data assigns the corresponding function to terminals [Y1] to [Y5A/C] and [30A/B/C] as listed below.										
E20	Terminal [Y1] Function	0 (1000) : Inverter running (RUN)	N	Y	0	Y	Y	Y	Y	Y
E21	Terminal [Y2] Function	1 (1001) : Frequency (speed) arrival signal (FAR)	N	Y	1	Y	Y	Y	Y	N
E22	Terminal [Y3] Function	2 (1002) : Frequency (speed) detected (FDT)	N	Y	2	Y	Y	Y	Y	Y
E23	Terminal [Y4] Function	3 (1003) : Undervoltage detected (Inverter stopped) (LU)	N	Y	7	Y	Y	Y	Y	Y
E24	Terminal [Y5A/C] Function	4 (1004) : Torque polarity detected (B/D)	N	Y	15	Y	Y	Y	Y	Y
E27	Terminal [30A/B/C] Function (Relay output)	5 (1005) : Inverter output limiting (IOL)	N	Y	99	Y	Y	Y	Y	Y
		6 (1006) : Auto-restarting after momentary power failure (IPF)				Y	Y	Y	Y	Y
		7 (1007) : Motor overload early warning (OL)				Y	Y	Y	Y	Y
		8 (1008) : Keypad operation enabled (KP)				Y	Y	Y	Y	Y
		10 (1010) : Inverter ready to run (RDY)				Y	Y	Y	Y	Y
		11 : Switch motor drive source between commercial power and inverter output (For MC on commercial line) (SW88)				Y	Y	N	N	N
		12 : Switch motor drive source between commercial power and inverter output (For secondary side) (SW52-2)				Y	Y	N	N	N
		13 : Switch motor drive source between commercial power and inverter output (For primary side) (SW52-1)				Y	Y	N	N	N
		15 (1015) : Select AX terminal function (For MC on primary side) (AX)				Y	Y	Y	Y	Y
		22 (1022) : Inverter output limiting with delay (IOL2)				Y	Y	Y	Y	Y
		25 (1025) : Cooling fan in operation (FAN)				Y	Y	Y	Y	Y
		26 (1026) : Auto-resetting (TRY)				Y	Y	Y	Y	Y
		27 (1027) : Universal DO (U-DO)				Y	Y	Y	Y	Y
		28 (1028) : Heat sink overheat early warning (OH)				Y	Y	Y	Y	Y
		29 (1029) : Synchronization completed (SY)				N	Y	N	Y	N
		30 (1030) : Lifetime alarm (LIFE)				Y	Y	Y	Y	Y
		31 (1031) : Frequency (speed) detected 2 (FDT2)				Y	Y	Y	Y	Y
		33 (1033) : Reference loss detected (REF OFF)				Y	Y	Y	Y	Y
		35 (1035) : Inverter output on (RUN2)				Y	Y	Y	Y	Y
		36 (1036) : Overload prevention control (OLP)				Y	Y	Y	Y	N
		37 (1037) : Current detected (ID)				Y	Y	Y	Y	Y
		38 (1038) : Current detected 2 (ID2)				Y	Y	Y	Y	Y
		39 (1039) : Current detected 3 (ID3)				Y	Y	Y	Y	Y
		41 (1041) : Low current detected (IDL)				Y	Y	Y	Y	Y
		42 (1042) : PID alarm (PID-ALM)				Y	Y	Y	Y	N
		43 (1043) : Under PID control (PID-CTL)				Y	Y	Y	Y	N
		44 (1044) : Motor stopped due to slow flowrate under PID control (PID-STP)				Y	Y	Y	Y	N
		45 (1045) : Low output torque detected (U-TL)				Y	Y	Y	Y	Y
		46 (1046) : Torque detected 1 (TD1)				Y	Y	Y	Y	Y
		47 (1047) : Torque detected 2 (TD2)				Y	Y	Y	Y	Y
		48 (1048) : Motor 1 selected (SWM1)				Y	Y	Y	Y	Y
		49 (1049) : Motor 2 selected (SWM2)				Y	Y	Y	Y	Y
		50 (1050) : Motor 3 selected (SWM3)				Y	Y	Y	Y	Y
		51 (1051) : Motor 4 selected (SWM4)				Y	Y	Y	Y	Y
52 (1052) : Running forward (FRUN)				Y	Y	Y	Y	Y		
53 (1053) : Running reverse (RRUN)				Y	Y	Y	Y	Y		
54 (1054) : In remote operation (RMT)				Y	Y	Y	Y	Y		
56 (1056) : Motor overheat detected by thermistor (THM)				Y	Y	Y	Y	Y		
57 (1057) : Brake signal (BRKS)				Y	Y	Y	Y	N		
58 (1058) : Frequency (speed) detected 3 (FDT3)				Y	Y	Y	Y	Y		
59 (1059) : Terminal [C1] wire break (C1OFF)				Y	Y	Y	Y	Y		

● E codes: Extension Terminal Functions

Code	Name	Data setting range	Change when running	Data copying	Default setting	Drive control				
						V/f	PG V/f	w/o PG	w/ PG	Torque Control
E27	Terminal [30A/B/C] Function (Relay output)	70 (1070) : Speed valid (DNZS)				N	Y	Y	Y	Y
		71 (1071) : Speed agreement (DSAG)				N	Y	Y	Y	N
		72 (1072) : Frequency (speed) arrival signal 3 (FAR3)				Y	Y	Y	Y	N
		76 (1076) : PG error detected (PG-ERR)				N	Y	Y	Y	N
		82 (1082) : Positioning completion signal (PSET)				N	N	N	Y	N
		84 (1084) : Maintenance timer (MNT)				Y	Y	Y	Y	Y
		98 (1098) : Light alarm (L-ALM)				Y	Y	Y	Y	Y
		99 (1099) : Alarm output (for any alarm) (ALM)				Y	Y	Y	Y	Y
		101 (1101) : Enable circuit failure detected (DECFF)				Y	Y	Y	Y	Y
		102 (1102) : Enable input OFF (EN OFF)				Y	Y	Y	Y	Y
		105 (1105) : Braking transistor broken (DBAL)				Y	Y	Y	Y	Y
		111 (1111) : Customizable logic output signal 1 (CLO1)				Y	Y	Y	Y	Y
		112 (1112) : Customizable logic output signal 2 (CLO2)				Y	Y	Y	Y	Y
		113 (1113) : Customizable logic output signal 3 (CLO3)				Y	Y	Y	Y	Y
		114 (1114) : Customizable logic output signal 4 (CLO4)				Y	Y	Y	Y	Y
115 (1115) : Customizable logic output signal 5 (CLO5)				Y	Y	Y	Y	Y		
		Setting the value in parentheses () shown above assigns a negative logic output to a terminal.								
E30	Frequency Arrival (Hysteresis width)	0.0 to 10.0 Hz	Y	Y	2.5	Y	Y	Y	Y	N
E31	Frequency Detection 1 (Level)	0.0 to 500.0 Hz	Y	Y	60.0	Y	Y	Y	Y	Y
E32	(Hysteresis width)	0.0 to 500.0 Hz	Y	Y	1.0	Y	Y	Y	Y	Y
E34	Overload Early Warning/Current Detection (Level)	0.00 (Disable); Current value of 1% to 200% of the inverter rated current	Y	Y1 Y2	*2	Y	Y	Y	Y	Y
E35	(Timer)	0.01 to 600.00s	Y	Y	10.00	Y	Y	Y	Y	Y
E36	Frequency Detection 2 (Level)	0.0 to 500.0 Hz	Y	Y	60.0	Y	Y	Y	Y	Y
E37	Current Detection 2/ Low Current Detection (Level)	0.00 (Disable); Current value of 1% to 200% of the inverter rated current	Y	Y1 Y2	*2	Y	Y	Y	Y	Y
E38	(Timer)	0.01 to 600.00 s	Y	Y	10.00	Y	Y	Y	Y	Y
E40	PID Display Coefficient A	-999 to 0.00 to 9990	Y	Y	100	Y	Y	Y	Y	N
E41	PID Display Coefficient B	-999 to 0.00 to 9990	Y	Y	0.00	Y	Y	Y	Y	N
E42	LED Display Filter	0.0 to 5.0 s	Y	Y	0.5	Y	Y	Y	Y	Y
E43	LED Monitor (Item selection)	0 : Speed monitor (select by E48) 3 : Output current 4 : Output voltage 8 : Calculated torque 9 : Input power 10 : PID command 12 : PID feedback amount 14 : PID output 15 : Load factor 16 : Motor output 17 : Analog input 23 : Torque current (%) 24 : Magnetic flux command (%) 25 : Input watt-hour	Y	Y	0	Y	Y	Y	Y	Y
	(Display when stopped)	0 : Specified value 1 : Output value	Y	Y	0	Y	Y	Y	Y	Y
E45	LCD Monitor (Item selection)	0 : Running status, rotational direction and operation guide 1 : Bar charts for output frequency, current and calculated torque	Y	Y	0	Y	Y	Y	Y	Y
	(Language selection)	Type: TP-G1W-J1 0 : Japanese 1 : English 2 : German 3 : French 4 : Spanish 5 : Italian	Y	Y	1	Y	Y	Y	Y	Y
E47	(Contrast control)	0 (Low) to 10 (High)	Y	Y	5	Y	Y	Y	Y	Y
E48	LED Monitor (Speed monitor item)	0 : Output frequency 1 (Before slip compensation) 1 : Output frequency 2 (After slip compensation) 2 : Reference frequency 3 : Motor speed in r/min 4 : Load shaft speed in r/min 5 : Line speed in m/min 7 : Display speed in %	Y	Y	0	Y	Y	Y	Y	Y
E50	Coefficient for Speed Indication	0.01 to 200.00	Y	Y	30.00	Y	Y	Y	Y	Y
E51	Display Coefficient for Input Watt-hour Data	0.000 (Cancel/reset), 0.001 to 9999	Y	Y	0.010	Y	Y	Y	Y	Y
E52	Keypad (Menu display mode)	0 : Function code data editing mode (Menus #0, #1, and #7) 1 : Function code data check mode (Menus #2 and #7) 2 : Full-menu mode	Y	Y	0	Y	Y	Y	Y	Y
E54	Frequency Detection 3 (Level)	0.0 to 500.0 Hz	Y	Y	60.0	Y	Y	Y	Y	Y
E55	Current Detection 3 (Level)	0.00 (Disable); Current value of 1% to 200% of the inverter rated current	Y	Y1 Y2	*2	Y	Y	Y	Y	Y
E56	(Timer)	0.01 to 600.00 s	Y	Y	10.00	Y	Y	Y	Y	Y
E61	Terminal [12] Extended Function	0 : None	N	Y	0	Y	Y	Y	Y	Y
E62	Terminal [C1] Extended Function	1 : Auxiliary frequency command 1	N	Y	0	Y	Y	Y	Y	Y
E63	Terminal [V2] Extended Function	2 : Auxiliary frequency command 2 3 : PID command 1 5 : PID feedback amount 6 : Ratio setting 7 : Analog torque limit value A 8 : Analog torque limit value B 10 : Torque command 11 : Torque current command 20 : Analog input monitor	N	Y	0	Y	Y	Y	Y	Y
E64	Saving of Digital Reference Frequency	0 : Automatic saving (when main power is turned OFF) 1 : Saving by pressing  key	Y	Y	1	Y	Y	Y	Y	Y
E65	Reference Loss Detection (Continuous running frequency)	0 : Decelerate to stop, 20% to 120%, 999: Disable	Y	Y	999	Y	Y	Y	Y	Y
E78	Torque Detection 1 (Level)	0% to 300%	Y	Y	100	Y	Y	Y	Y	Y
E79	(Timer)	0.01 to 600.00 s	Y	Y	10.00	Y	Y	Y	Y	Y
E80	Torque Detection 2/ Low Torque Detection (Level)	0% to 300%	Y	Y	20	Y	Y	Y	Y	Y
E81	(Timer)	0.01 to 600.00 s	Y	Y	20.00	Y	Y	Y	Y	Y

Characteristics
Model Variations
Keypad Functionality
Inverter PC Softw
Standard Specifications
Common Specifications
Basic Wiring Diagram
Terminal Functions
Function Settings
External Dimensions
Options
Reference material
Warranty

Function Settings

Function Settings

E codes: Extension Terminal Functions

Code	Name	Data setting range	Change when running	Data copying	Default setting	Drive control				
						V/f	PG V/f	w/o PG	w/ PG	Torque Control
		Selecting function code data assigns the corresponding function to terminals [FWD] and [REV] as listed below.								
E98	Terminal [FWD] Function	0.(1000) : Select multi-frequency (0 to 1 steps) (SS1)	N	Y	98	Y	Y	Y	Y	N
E99	Terminal [REV] Function	1.(1001) : Select multi-frequency (0 to 3 steps) (SS2)	N	Y	99	Y	Y	Y	Y	N
		2.(1002) : Select multi-frequency (0 to 7 steps) (SS4)				Y	Y	Y	Y	N
		3.(1003) : Select multi-frequency (0 to 15 steps) (SS8)				Y	Y	Y	Y	N
		4.(1004) : Select ACC/DEC time (2 steps) (RT1)				Y	Y	Y	Y	N
		5.(1005) : Select ACC/DEC time (4 steps) (RT2)				Y	Y	Y	Y	N
		6.(1006) : Enable 3-wire operation (HLD)				Y	Y	Y	Y	Y
		7.(1007) : Coast to a stop (BX)				Y	Y	Y	Y	Y
		8.(1008) : Reset alarm (RST)				Y	Y	Y	Y	Y
		9.(1009) : Enable external alarm trip (9 = Active OFF, 1009 = Active ON) (THR)				Y	Y	Y	Y	Y
		10.(1010) : Ready for jogging (JOG)				Y	Y	Y	Y	N
		11.(1011) : Select frequency command 2/1 (Hz2/Hz1)				Y	Y	Y	Y	N
		12.(1012) : Select motor 2 (M2)				Y	Y	Y	Y	Y
		13. : Enable DC braking (DCBRK)				Y	Y	Y	Y	N
		14.(1014) : Select torque limiter level 2/1 (TL2/TL1)				Y	Y	Y	Y	Y
		15. : Switch to commercial power (50 Hz) (SW50)				Y	Y	N	N	N
		16. : Switch to commercial power (60 Hz) (SW60)				Y	Y	N	N	N
		17.(1017) : UP (Increase output frequency) (UP)				Y	Y	Y	Y	N
		18.(1018) : DOWN (Decrease output frequency) (DOWN)				Y	Y	Y	Y	N
		19.(1019) : Enable data change with keypad (WE-KP)				Y	Y	Y	Y	Y
		20.(1020) : Cancel PID control (Hz/PID)				Y	Y	Y	Y	N
		21.(1021) : Switch normal/inverse operation (IVS)				Y	Y	Y	Y	N
		22.(1022) : Interlock (IL)				Y	Y	Y	Y	Y
		23.(1023) : Cancel torque control (Hz/TRQ)				N	N	N	N	Y
		24.(1024) : Enable communications link via RS-485 or fieldbus (LE)				Y	Y	Y	Y	Y
		25.(1025) : Universal DI (U-DI)				Y	Y	Y	Y	Y
		26.(1026) : Enable auto search for idling motor speed at starting (STM)				Y	Y	Y	N	Y
		30.(1030) : Force to stop (30 = Active OFF, 1030 = Active ON) (STOP)				Y	Y	Y	Y	Y
		32.(1032) : Pre-excitation (EXITE)				N	N	Y	Y	N
		33.(1033) : Reset PID integral and differential components (PID-RST)				Y	Y	Y	Y	N
		34.(1034) : Hold PID integral component (PID-HLD)				Y	Y	Y	Y	N
		35.(1035) : Select local (keypad) operation (LOC)				Y	Y	Y	Y	Y
		36.(1036) : Select motor 3 (M3)				Y	Y	Y	Y	Y
		37.(1037) : Select motor 4 (M4)				Y	Y	Y	Y	Y
		39. : Protect motor from dew condensation (DWP)				Y	Y	Y	Y	Y
		40. : Enable integrated sequence to switch to commercial power (50 Hz) (ISW50)				Y	Y	N	N	N
		41. : Enable integrated sequence to switch to commercial power (60 Hz) (ISW60)				Y	Y	N	N	N
		47.(1047) : Servo-lock command (LOCK)				N	N	N	Y	N
		49.(1049) : Pulse train sign (SIGN)				Y	Y	Y	Y	Y
		59.(1059) : Enable battery operation (BATRY)				Y	Y	Y	Y	Y
		70.(1070) : Cancel constant peripheral speed control (Hz/LSC)				Y	Y	Y	Y	N
		71.(1071) : Hold the constant peripheral speed control frequency in the memory (LSC-HLD)				Y	Y	Y	Y	N
		72.(1072) : Count the run time of commercial power-driven motor 1 (CRUN-M1)				Y	Y	N	N	Y
		73.(1073) : Count the run time of commercial power-driven motor 2 (CRUN-M2)				Y	Y	N	N	Y
		74.(1074) : Count the run time of commercial power-driven motor 3 (CRUN-M3)				Y	Y	N	N	Y
		75.(1075) : Count the run time of commercial power-driven motor 4 (CRUN-M4)				Y	Y	N	N	Y
		76.(1076) : Select droop control (DROOP)				Y	Y	Y	Y	N
		77.(1077) : Cancel PG alarm (PG-CCL)				N	Y	N	Y	Y
		80.(1080) : Cancel customizable logic (CLC)				Y	Y	Y	Y	Y
		81.(1081) : Clear all customizable logic timers (CLTC)				Y	Y	Y	Y	Y
		98. : Run forward (FWD)				Y	Y	Y	Y	Y
		99. : Run reverse (REV)				Y	Y	Y	Y	Y
		100. : No function assigned (NONE)				Y	Y	Y	Y	Y

The shaded function codes () are applicable to the quick setup.

*1 6.00 s for inverters of 40 HP or below; 20.00 s for those of 50 HP or above

*2 The motor rated current is automatically set. See Table B (P03/A17/b17/r17).

C codes: Control Functions of Frequency

Code	Name	Data setting range	Change when running	Data copying	Default setting	Drive control		
						V/f	w/o PG	w/ PG
C01	Jump Frequency 1	0.0 to 500.0 Hz	Y	Y	0.0	Y	Y	Y
C02	2		Y	Y	0.0	Y	Y	Y
C03	3		Y	Y	0.0	Y	Y	Y
C04	(Hysteresis width)		Y	Y	3.0	Y	Y	Y
C05	Multi-frequency 1	0.00 to 500.00 Hz	Y	Y	0.00	Y	Y	Y
C06	2		Y	Y	0.00	Y	Y	Y
C07	3		Y	Y	0.00	Y	Y	Y
C08	4		Y	Y	0.00	Y	Y	Y
C09	5		Y	Y	0.00	Y	Y	Y
C10	6		Y	Y	0.00	Y	Y	Y
C11	7		Y	Y	0.00	Y	Y	Y
C12	8		Y	Y	0.00	Y	Y	Y
C13	9		Y	Y	0.00	Y	Y	Y
C14	10		Y	Y	0.00	Y	Y	Y
C15	11		Y	Y	0.00	Y	Y	Y
C16	12		Y	Y	0.00	Y	Y	Y
C17	13		Y	Y	0.00	Y	Y	Y
C18	14		Y	Y	0.00	Y	Y	Y
C19	15		Y	Y	0.00	Y	Y	Y

●C codes: Control Functions of Frequency

Code	Name	Data setting range	Change when running	Data copying	Default setting	Drive control				
						V/f	PG V/f	w/o PG	w/ PG	Torque Control
C20	Jogging Frequency	0.00 to 500.00 Hz	Y	Y	0.00	Y	-	Y	Y	-
C30	Frequency Command 2	0 : Enable / keys on the keypad 1 : Voltage input to terminal [12] (-10 to +10 VDC) 2 : Current input to terminal [C1] (4 to 20 mA DC) 3 : Sum of voltage and current inputs to terminals [12] and [C1] 5 : Voltage input to terminal [V2] (-10 to +10 VDC) 7 : Terminal command UP/DOWN control 8 : Enable / keys on the keypad (balanceless-bumpless switching available) 11 : Digital input interface card (option) 12 : Pulse train input	N	Y	2	Y	-	Y	Y	-
C31	Analog Input Adjustment for [12] (Offset)	-5.0% to 5.0%	Y*	Y	0.0	Y	-	Y	Y	-
C32	(Gain)	0.00% to 400.00%	Y*	Y	100.00	Y	-	Y	Y	-
C33	(Filter time constant)	0.00 to 5.00 s	Y	Y	0.05	Y	-	Y	Y	-
C34	(Gain base point)	0.00% to 100.00%	Y*	Y	100.00	Y	-	Y	Y	-
C35	(Polarity)	0 : Bipolar 1 : Unipolar	N	Y	1	Y	-	Y	Y	-
C36	Analog Input Adjustment for [C1] (Offset)	-5.0% to 5.0%	Y*	Y	0.0	Y	-	Y	Y	-
C37	(Gain)	0.00% to 400.00%	Y*	Y	100.00	Y	-	Y	Y	-
C38	(Filter time constant)	0.00 to 5.00s	Y	Y	0.05	Y	-	Y	Y	-
C39	(Gain base point)	0.00% to 100.00%	Y*	Y	100.00	Y	-	Y	Y	-
C40	Terminal [C1] Range Selection	0 : 4 to 20 mA 1 : 0 to 20 mA	N	Y	0.0	Y	Y	Y	Y	Y
C41	Analog Input Adjustment for [V2] (Offset)	-5.0% to 5.0%	Y*	Y	0.0	Y	-	Y	Y	-
C42	(Gain)	0.00% to 400.00%	Y*	Y	100.00	Y	-	Y	Y	-
C43	(Filter time constant)	0.00 to 5.00 s	Y	Y	0.05	Y	-	Y	Y	-
C44	(Gain base point)	0.00% to 100.00%	Y*	Y	100.00	Y	-	Y	Y	-
C45	(Polarity)	0 : Bipolar 1 : Unipolar	N	Y	1	Y	-	Y	Y	-
C50	Bias (Frequency command 1) (Bias base point)	0.00% to 100.00%	Y*	Y	0.00	Y	-	Y	Y	-
C51	Bias (PID command 1) (Bias value)	-100.00% to 100.00%	Y*	Y	0.00	Y	-	Y	Y	-
C52	(Bias base point)	0.00% to 100.00%	Y*	Y	0.00	Y	-	Y	Y	-
C53	Selection of Normal/Inverse Operation (Frequency command 1)	0 : Normal operation 1 : Inverse operation	Y	Y	0	Y	-	Y	Y	-

●P codes: Motor 1 Parameters

Code	Name	Data setting range	Change when running	Data copying	Default setting	Drive control				
						V/f	PG V/f	w/o PG	w/ PG	Torque Control
P01	Motor 1 (No. of poles)	2 to 22 poles	N	Y1 Y2	4	Y	-	Y	Y	-
P02	(Rated capacity)	0.01 to 1000 kW (when P99 = 0, 2, 3 or 4) 0.01 to 1000 HP (when P99 = 1)	N	Y1 Y2	*7	Y	-	Y	Y	-
P03	(Rated current)	0.00 to 2000 A	N	Y1 Y2	*7	Y	-	Y	Y	-
P04	(Auto-tuning)	0 : Disable 1 : Tune while the motor stops. (%R1, %X and rated slip frequency) 2 : Tune while the motor is rotating under V/f control (%R1, %X, rated slip frequency, no-load current, magnetic saturation factors 1 to 5, and magnetic saturation extension factors "a" to "c") 3 : Tune while the motor is rotating under vector control (%R1, %X, rated slip frequency, no-load current, magnetic saturation factors 1 to 5, and magnetic saturation extension factors "a" to "c." Available when the vector control is enabled.)	N	N	0	Y	-	Y	Y	-
P05	Motor 1 (Online tuning)	0 : Disable 1 : Enable	Y	Y	0	Y	N	N	N	N
P06	(No-load current)	0.00 to 2000 A	N	Y1 Y2	*7	Y	-	Y	Y	-
P07	(%R1)	0.00% to 50.00%	Y	Y1 Y2	*7	Y	-	Y	Y	-
P08	(%X)	0.00% to 50.00%	Y	Y1 Y2	*7	Y	-	Y	Y	-
P09	(Slip compensation gain for driving)	0.0% to 200.0%	Y*	Y	100.0	Y	-	Y	Y	-
P10	(Slip compensation response time)	0.01 to 10.00 s	Y	Y1 Y2	0.12	Y	-	N	N	-
P11	(Slip compensation gain for braking)	0.0% to 200.0%	Y*	Y	100.0	Y	-	Y	Y	-
P12	(Rated slip frequency)	0.00 to 15.00 Hz	N	Y1 Y2	*7	Y	-	Y	Y	-
P13	(Iron loss factor 1)	0.00% to 20.00%	Y	Y1 Y2	*7	Y	-	Y	Y	-
P14	(Iron loss factor 2)	0.00% to 20.00%	Y	Y1 Y2	0.00	Y	-	Y	Y	-
P15	(Iron loss factor 3)	0.00% to 20.00%	Y	Y1 Y2	0.00	Y	-	Y	Y	-
P16	(Magnetic saturation factor 1)	0.0% to 300.0%	Y	Y1 Y2	*7	Y	-	Y	Y	-
P17	(Magnetic saturation factor 2)	0.0% to 300.0%	Y	Y1 Y2	*7	Y	-	Y	Y	-
P18	(Magnetic saturation factor 3)	0.0% to 300.0%	Y	Y1 Y2	*7	Y	-	Y	Y	-
P19	(Magnetic saturation factor 4)	0.0% to 300.0%	Y	Y1 Y2	*7	Y	-	Y	Y	-
P20	(Magnetic saturation factor 5)	0.0% to 300.0%	Y	Y1 Y2	*7	Y	-	Y	Y	-
P21	(Magnetic saturation extension factor "a")	0.0% to 300.0%	Y	Y1 Y2	*7	Y	-	Y	Y	-
P22	(Magnetic saturation extension factor "b")	0.0% to 300.0%	Y	Y1 Y2	*7	Y	-	Y	Y	-
P23	(Magnetic saturation extension factor "c")	0.0% to 300.0%	Y	Y1 Y2	*7	Y	-	Y	Y	-
P53	(%X correction factor 1)	0% to 300%	Y	Y1 Y2	100	Y	-	Y	Y	-
P54	(%X correction factor 2)	0% to 300%	Y	Y1 Y2	100	Y	-	Y	Y	-
P55	(Torque current under vector control)	0.00 to 2000 A	N	Y1 Y2	*7	N	-	Y	Y	-
P56	(Induced voltage factor under vector control)	50% to 100%	N	Y1 Y2	85 (90) *8	N	-	Y	Y	-
P57	Reserved *9	-	-	-	-	-	-	-	-	-
P99	Motor 1 Selection	0 : Motor characteristics 0 (Fuji standard motors, 8-series) 1 : Motor characteristics 1 (HP rating motors) 2 : Motor characteristics 2 (Fuji motors exclusively designed for vector control) 3 : Motor characteristics 3 (Fuji standard motors, 6-series) 4 : Other motors	N	Y1 Y2	1	Y	-	Y	Y	-

The shaded function codes () are applicable to the quick setup.

*7 The motor parameters are automatically set, depending upon the inverter's capacity. See Table B.

*8 85% for inverters of 150 HP or less; 90% for those of 175 HP or above.

*9 Factory use. Do not access these function codes.

Function Settings

Function Settings

●H codes: High Performance Functions

Code	Name	Data setting range	Change when running	Data copying	Default setting	Drive control				
						V/f	PG V/f	w/o PG	w/ PG	Torque Control
H03	Data Initialization	0 : Disable initialization 1 : Initialize all function code data to the factory defaults 2 : Initialize motor 1 parameters 3 : Initialize motor 2 parameters 4 : Initialize motor 3 parameters 5 : Initialize motor 4 parameters	N	N	0	Y	-	Y	Y	-
H04	Auto-reset (Times)	0 : Disable; 1 to 10	Y	Y	0	Y	-	Y	Y	-
H05	(Reset interval)	0.5 to 20.0 s	Y	Y	5.0	Y	-	Y	Y	-
H06	Cooling Fan ON/OFF Control	0 : Disable (Always in operation) 1 : Enable (ON/OFF controllable)	Y	Y	0	Y	-	Y	Y	-
H07	Acceleration/Deceleration Pattern	0 : Linear 1 : S-curve (Weak) 2 : S-curve (Arbitrary, according to H57 to H60 data) 3 : Curvilinear	Y	Y	0	Y	-	Y	Y	-
H08	Rotational Direction Limitation	0 : Disable 1 : Enable (Reverse rotation inhibited) 2 : Enable (Forward rotation inhibited)	N	Y	0	Y	-	Y	Y	-
H09	Starting Mode (Auto search)	0 : Disable 1 : Enable (At restart after momentary power failure) 2 : Enable (At restart after momentary power failure and at normal start)	N	Y	0	Y	-	N	N	-
H11	Deceleration Mode	0 : Normal deceleration 1 : Coast-to-stop	Y	Y	0	Y	-	Y	Y	-
H12	Instantaneous Overcurrent Limiting (Mode selection)	0 : Disable 1 : Enable	Y	Y	1	Y	-	N	N	-
H13	Restart Mode after Momentary Power Failure (Restart time)	0.1 to 20.0 s	Y	Y1 Y2	*10	Y	-	Y	Y	-
H14	(Frequency fall rate)	0.00: Deceleration time selected by F08, 0.01 to 100.00 Hz/s, 999: Follow the current limit command	Y	Y	999	Y	-	Y	N	-
H15	(Continuous running level)	200 to 300 V for 230 V series 400 to 600 V for 460 V series	Y	Y2	235 470	Y	-	N	N	-
H16	(Allowable momentary power failure time)	0.0 to 30.0 s 999: Automatically determined by inverter	Y	Y	999	Y	-	Y	Y	-
H18	Torque Control (Mode selection)	0 : Disable (Speed control) 2 : Enable (Torque current command) 3 : Enable (Torque command)	N	Y	0	N	-	Y	Y	-
H26	Thermistor (for motor) (Mode selection)	0 : Disable 1 : PTC (The inverter immediately trips with Oh4 displayed.) 2 : PTC (The inverter issues output signal THM and continues to run.) 3 : NTC (When connected)	Y	Y	0	Y	-	Y	Y	-
H27	(Level)	0.00 to 5.00 V	Y	Y	0.35	Y	-	Y	Y	-
H28	Droop Control	-60.0 to 0.0 Hz	Y	Y	0.0	Y	-	Y	Y	-
H30	Communications Link Function (Mode selection)	Frequency command Run command 0 : F01/C30 F02 1 : RS-485 (Port 1) F02 2 : F01/C30 RS-485 (Port 1) 3 : RS-485 (Port 1) RS-485 (Port 1) 4 : RS-485 (Port 2) F02 5 : RS-485 (Port 2) RS-485 (Port 1) 6 : F01/C30 RS-485 (Port 2) 7 : RS-485 (Port 1) RS-485 (Port 2) 8 : RS-485 (Port 2) RS-485 (Port 2)	Y	Y	0	Y	-	Y	Y	-
H42	Capacitance of DC Link Bus Capacitor	Indication for replacement of DC link bus capacitor 0 to 65535	Y	N	-	Y	-	Y	Y	-
H43	Cumulative Run Time of Cooling Fan	Indication for replacement of cooling fan 0 to 99990 hours	Y	N	-	Y	-	Y	Y	-
H44	Startup Counter for Motor 1	Indication of cumulative startup count 0 to 65535 times	Y	N	-	Y	-	Y	Y	-
H45	Mock Alarm	0 : Disable 1 : Enable (Once a mock alarm occurs, the data automatically returns to 0.)	Y	N	0	Y	-	Y	Y	-
H46	Starting Mode (Auto search delay time 2)	0.1 to 20.0 s	Y	Y1 Y2	*7	Y	-	Y	N	-
H47	Initial Capacitance of DC Link Bus Capacitor	Indication for replacement of DC link bus capacitor 0 to 65535	Y	N	-	Y	-	Y	Y	-
H48	Cumulative Run Time of Capacitors on Printed Circuit Boards	Indication for replacement of capacitors 0 to 99990 hours (The cumulative run time can be modified or reset.)	Y	N	-	Y	-	Y	Y	-
H49	Starting Mode (Auto search delay time 1)	0.0 to 10.0 s	Y	Y	0.0	Y	-	Y	Y	-
H50	Non-linear V/f Pattern 1 (Frequency)	0.0: Cancel, 0.1 to 500.0 Hz	N	Y	0.0	Y	-	N	N	-
H51	(Voltage)	0 to 240 : Output an AVR-controlled voltage (for 230 V series) 0 to 500 : Output an AVR-controlled voltage (for 460 V series)	N	Y2	0	Y	-	N	N	-
H52	Non-linear V/f Pattern 2 (Frequency)	0.0: Cancel, 0.1 to 500.0 Hz	N	Y	0.0	Y	-	N	N	-
H53	(Voltage)	0 to 240 : Output an AVR-controlled voltage (for 230 V series) 0 to 500 : Output an AVR-controlled voltage (for 460 V series)	N	Y2	0	Y	-	N	N	-
H54	Acceleration Time (Jogging)	0.00 to 6000 s	Y	Y	*1	Y	-	Y	Y	-
H55	Deceleration Time (Jogging)	0.00 to 6000 s	Y	Y	*1	Y	-	Y	Y	-
H56	Deceleration Time for Forced Stop	0.00 to 6000 s	Y	Y	*1	Y	-	Y	Y	-
H57	1st S-curve acceleration range (Leading edge)	0% to 100%	Y	Y	10	Y	-	Y	Y	-
H58	2nd S-curve acceleration range (Trailing edge)	0% to 100%	Y	Y	10	Y	-	Y	Y	-
H59	1st S-curve deceleration range (Leading edge)	0% to 100%	Y	Y	10	Y	-	Y	Y	-
H60	2nd S-curve deceleration range (Trailing edge)	0% to 100%	Y	Y	10	Y	-	Y	Y	-
H61	UP/DOWN Control (Initial frequency setting)	0 : 0.00 Hz 1 : Last UP/DOWN command value on releasing the run command	N	Y	1	Y	-	Y	Y	-
H63	Low Limiter (Mode selection)	0 : Limit by F16 (Frequency limiter: Low) and continue to run 1 : If the output frequency lowers below the one limited by F16 (Frequency limiter: Low), decelerate to stop the motor.	Y	Y	0	Y	-	Y	Y	-
H64	(Lower limiting frequency)	0.0: Depends on F16 (Frequency limiter, Low) 0.1 to 60.0 Hz	Y	Y	1.6	Y	-	N	N	-
H65	Non-linear V/f Pattern 3 (Frequency)	0.0: Cancel, 0.1 to 500.0 Hz	N	Y	0.0	Y	-	N	N	-
H66	(Voltage)	0 to 240 :Output an AVR-controlled voltage (for 230 V series) 0 to 500 :Output an AVR-controlled voltage (for 460 V series)	N	Y2	0	Y	-	N	N	-
H67	Auto Energy Saving Operation (Mode selection)	0 : Enable during running at constant speed 1 : Enable in all modes	Y	Y	0	Y	-	N	Y	-

●H codes: High Performance Functions

Code	Name	Data setting range	Change when running	Data copying	Default setting	Drive control				
						V/f	PG V/f	w/o PG	w/ PG	Torque Control
H58	Slip Compensation 1 (Operating conditions)	0 : Enable during ACC/DEC and at base frequency or above 1 : Disable during ACC/DEC and enable at base frequency or above 2 : Enable during ACC/DEC and disable at base frequency or above 3 : Disable during ACC/DEC and at base frequency or above	N	Y	0	Y	-	N	N	-
H59	Automatic Deceleration (Mode selection)	0 : Disable 2 : Torque limit control with Force-to-stop if actual deceleration time exceeds three times the specified one 3 : DC link bus voltage control with Force-to-stop if actual deceleration time exceeds three times the specified one 4 : Torque limit control with Force-to-stop disabled 5 : DC link bus voltage control with Force-to-stop disabled	Y	Y	0	Y	-	Y	Y	-
H70	Overload Prevention Control	0.00 :Follow the deceleration time selected 0.01 to 100.0 Hz/s 999: Cancel	Y	Y	999	Y	-	Y	Y	-
H71	Deceleration Characteristics	0 : Disable 1 : Enable	Y	Y	0	Y	-	N	N	-
H72	Main Power Down Detection (Mode selection)	0 : Disable 1 : Enable	Y	Y	1	Y	-	Y	Y	-
H73	Torque Limite (Operating conditions)	0 : Enable during ACC/DEC and running at constant speed 1 : Disable during ACC/DEC and enable during running at constant speed 2 : Enable during ACC/DEC and disable during running at constant speed	N	Y	0	Y	-	Y	Y	-
H74	(Control target)	0 : Motor-generating torque limit 1 : Torque current limit 2 : Output power limit	N	Y	1	N	-	Y	Y	-
H75	(Target quadrants)	0 : Drive/brake 1 : Same for all four quadrants 2 : Upper/lower limits	N	Y	0	N	-	Y	Y	-
H76	(Frequency increment limit for braking)	0.0 to 500.0 Hz	Y	Y	5.0	Y	-	N	N	-
H77	Service Life of DC Link Bus Capacitor (Remaining time)	0 to 87600 hours	Y	N	-	Y	-	Y	Y	-
H78	Maintenance Interval (M1)	0 : Disable; 1 to 99990 hours	Y	N	87600	Y	-	Y	Y	-
H79	Preset Startup Count for Maintenance (M1)	0 : Disable; 1 to 65535 times	Y	N	0	Y	-	Y	Y	-
H80	Output Current Fluctuation Damping Gain for Motor 1	0.00 to 1.00	Y	Y	0.20	Y	-	N	N	-
H81	Light Alarm Selection 1	0000 to FFFF (hex.)	Y	Y	0	Y	Y	Y	Y	Y
H82	Light Alarm Selection 2	0000 to FFFF (hex.)	Y	Y	0	Y	Y	Y	Y	Y
H84	Pre-excitation (Initial level)	100% to 400%	Y	Y	100	N	-	Y	Y	-
H85	(Time)	0.00: Disable; 0.01 to 30.00 s	Y	Y	0.00	N	-	Y	Y	-
H86	Reserved *9	-	-	-	-	-	-	-	-	-
H87	Reserved *9	-	-	-	-	-	-	-	-	-
H88	Reserved *9	-	-	-	-	-	-	-	-	-
H89	Reserved *9	-	-	-	-	-	-	-	-	-
H90	Reserved *9	-	-	-	-	-	-	-	-	-
H91	PID Feedback Wire Break Detection	0.0: Disable alarm detection 0.1 to 60.0 s	Y	Y	0.0	Y	-	Y	Y	-
H92	Continuity of Running (P)	0.000 to 10.000 times; 999	Y	Y1Y2	999	Y	-	N	N	-
H93	(I)	0.010 to 10.000 s; 999	Y	Y1Y2	999	Y	-	N	N	-
H94	Cumulative Motor Run Time 1	0 to 99990 hours (The cumulative run time can be modified or reset.)	N	N	-	Y	-	Y	Y	-
H95	DC Braking (Braking response mode)	0 : Slow 1 : Quick	Y	Y	1	Y	-	N	N	-
H96	STOP Key Priority/ Start Check Function	Data STOP key priority Start check function 0 : Disable Disable 1 : Enable Disable 2 : Disable Enable 3 : Enable Enable	Y	Y	3	Y	-	Y	Y	-
H97	Clear Alarm Data	0 : Disable 1 : Enable (Setting "1" clears alarm data and then returns to "0.")	Y	N	0	Y	-	Y	Y	-
H98	Protection/Maintenance Function (Mode selection)	0 to 255: Display data in decimal format Bit 0: Lower the carrier frequency automatically (0: Disabled; 1: Enabled) Bit 1: Detect input phase loss (0: Disabled; 1: Enabled) Bit 2: Detect output phase loss (0: Disabled; 1: Enabled) Bit 3: Select life judgment threshold of DC link bus capacitor (0: Factory default level; 1: User setup level) Bit 4: Judge the life of DC link bus capacitor (0: Disabled; 1: Enabled) Bit 5: Detect DC fan lock (0: Enabled; 1: Disabled) Bit 6: Detect braking transistor error (for 40 HP or below) (0: Disabled; 1: Enabled) Bit 7: Switch IP20/IP40 enclosure (0: IP20; 1: IP40)	Y	Y	83	Y	-	Y	Y	-

*1 6.00 s for inverters of 40 HP or below; 20.00 s for those of 50 HP or above
*7 The motor parameters are automatically set, depending upon the inverter's capacity. See Table B
*9 Factory use. Do not access these function codes.
*10 The factory default differs depending upon the inverter's capacity. See Table A.

●A codes: Motor 2 Parameters

Code	Name	Data setting range	Change when running	Data copying	Default setting	Drive control				
						V/f	PG V/f	w/o PG	w/ PG	Torque Control
A01	Maximum Frequency 2	25.0 to 500.0 Hz	N	Y	60.0	Y	-	Y	Y	-
A02	Base Frequency 2	25.0 to 500.0 Hz	N	Y	60.0	Y	-	Y	Y	-
A03	Rated Voltage at Base Frequency 2	0 : Output a voltage in proportion to input voltage 80 to 240 : Output an AVR-controlled voltage (for 230 V series) 160 to 500 : Output an AVR-controlled voltage (for 460 V series)	N	Y2	230 460	Y	-	Y	Y	-
A04	Maximum Output Voltage 2	80 to 240 : Output an AVR-controlled voltage (for 230 V series) 160 to 500 : Output an AVR-controlled voltage (for 460 V series)	N	Y2	230 460	Y	-	N	N	-
A05	Torque Boost 2	0.0% to 20.0% (percentage with respect to "A03: Rated Voltage at Base Frequency 2")	Y	Y	0.0	Y	-	N	N	-
A06	Electronic Thermal Overload Protection for Motor 2 (Select motor characteristics)	1 : For a general-purpose motor with shaft-driven cooling fan 2 : For an inverter-driven motor, non-ventilated motor, or motor with separately powered cooling fan	Y	Y	1	Y	-	Y	Y	-
A07	(Overload detection level)	0.00: Disable 1% to 135% of the rated current (allowable continuous drive current) of the motor	Y	Y1 Y2	*2	Y	-	Y	Y	-
A08	(Thermal time constant)	0.5 to 75.0 min	Y	Y	*3	Y	-	Y	Y	-
A09	DC Braking 2 (Braking starting frequency)	0.0 to 60.0 Hz	Y	Y	0.0	Y	-	Y	Y	-
A10	(Braking level)	0% to 80% (LD/MD mode)*4, 0% to 100% (HD mode)	Y	Y	0	Y	-	Y	Y	-
A11	(Braking time)	0.00: Disable; 0.01 to 30.00 s	Y	Y	0.00	Y	-	Y	Y	-
A12	Starting Frequency 2	0.0 to 60.0 Hz	Y	Y	0.5	Y	-	Y	Y	-

Function Settings

Function Settings

●A codes: Motor 2 Parameters

Code	Name	Data setting range	Change when running	Data copying	Default setting	Drive control				
						V/f	PG V/f	w/o PG	w/ PG	Torque Control
R13	Load Selection/ Auto Torque Boost Auto Energy Saving Operation 2	0 : Variable torque load 1 : Constant torque load 2 : Auto-torque boost 3 : Auto-energy saving operation (Variable torque load during ACC/DEC) 4 : Auto-energy saving operation (Constant torque load during ACC/DEC) 5 : Auto-energy saving operation (Auto-torque boost during ACC/DEC)	N	Y	1	Y	-	N	Y	-
R14	Drive Control Selection 2	0 : V/f control with slip compensation inactive 1 : Dynamic torque vector control 2 : V/f control with slip compensation active 3 : V/f control with speed sensor 4 : Dynamic torque vector control with speed sensor 5 : Vector control without speed sensor 6 : Vector control with speed sensor	N	Y	0	Y	-	Y	Y	-
R15	Motor 2 (No. of poles)	2 to 22 poles	N	Y1 Y2	4	Y	-	Y	Y	-
R16	(Rated capacity)	0.01 to 1000 kW (when A39 = 0, 2, 3 or 4) 0.01 to 1000 HP (when A39 = 1)	N	Y1 Y2	*7	Y	-	Y	Y	-
R17	(Rated current)	0.00 to 2000 A	N	Y1 Y2	*7	Y	-	Y	Y	-
R18	Motor 2 (Auto-tuning)	0 : Disable 1 : Tune while the motor stops. (%R1, %X and rated slip frequency) 2 : Tune while the motor is rotating under V/f control (%R1, %X, rated slip frequency, no-load current, magnetic saturation factors 1 to 5, and magnetic saturation extension factors "a" to "c") 3 : Tune while the motor is rotating under vector control (%R1, %X, rated slip frequency, no-load current, magnetic saturation factors 1 to 5, and magnetic saturation extension factors "a" to "c" Available when the vector control is enabled.	N	N	0	Y	-	Y	Y	-
R19	Motor 2 (Online tuning)	0 : Disable 1 : Enable	Y	Y	0	Y	N	N	N	N
R20	(No-load current)	0.00 to 2000 A	N	Y1 Y2	*7	Y	-	Y	Y	-
R21	(%R1)	0.00% to 50.00%	Y	Y1 Y2	*7	Y	-	Y	Y	-
R22	(%X)	0.00% to 50.00%	Y	Y1 Y2	*7	Y	-	Y	Y	-
R23	(Slip compensation gain for driving)	0.0% to 200.0%	Y*	Y	100.0	Y	-	Y	Y	-
R24	(Slip compensation response time)	0.01 to 10.00s	Y	Y1 Y2	0.12	Y	-	N	N	-
R25	(Slip compensation gain for braking)	0.0% to 200.0%	Y*	Y	100.0	Y	-	Y	Y	-
R26	(Rated slip frequency)	0.00 to 15.00 Hz	N	Y1 Y2	*7	Y	-	Y	Y	-
R27	(Iron loss factor 1)	0.00% to 20.00%	Y	Y1 Y2	*7	Y	-	Y	Y	-
R28	(Iron loss factor 2)	0.00% to 20.00%	Y	Y1 Y2	0.00	Y	-	Y	Y	-
R29	(Iron loss factor 3)	0.00% to 20.00%	Y	Y1 Y2	0.00	Y	-	Y	Y	-
R30	(Magnetic saturation factor 1)	0.0% to 300.0%	Y	Y1 Y2	*7	Y	-	Y	Y	-
R31	(Magnetic saturation factor 2)	0.0% to 300.0%	Y	Y1 Y2	*7	Y	-	Y	Y	-
R32	(Magnetic saturation factor 3)	0.0% to 300.0%	Y	Y1 Y2	*7	Y	-	Y	Y	-
R33	(Magnetic saturation factor 4)	0.0% to 300.0%	Y	Y1 Y2	*7	Y	-	Y	Y	-
R34	(Magnetic saturation factor 5)	0.0% to 300.0%	Y	Y1 Y2	*7	Y	-	Y	Y	-
R35	(Magnetic saturation extension factor "a")	0.0% to 300.0%	Y	Y1 Y2	*7	Y	-	Y	Y	-
R36	(Magnetic saturation extension factor "b")	0.0% to 300.0%	Y	Y1 Y2	*7	Y	-	Y	Y	-
R37	(Magnetic saturation extension factor "c")	0.0% to 300.0%	Y	Y1 Y2	*7	Y	-	Y	Y	-
R39	Motor 2 Selection	0 : Motor characteristics 0 (Fuji standard motors, 8-series) 1 : Motor characteristics 1 (HP rating motors) 2 : Motor characteristics 2 (Fuji motors exclusively designed for vector control) 3 : Motor characteristics 3 (Fuji standard motors, 6-series) 4 : Other motors	N	Y1 Y2	1	Y	-	Y	Y	-
R40	Slip Compensation 2 (Operating conditions)	0 : Enable during ACC/DEC and at base frequency or above 1 : Disable during ACC/DEC and enable at base frequency or above 2 : Enable during ACC/DEC and disable at base frequency or above 3 : Disable during ACC/DEC and at base frequency or above	N	Y	0	Y	-	N	N	-
R41	Output Current Fluctuation Damping Gain for Motor 2	0.00 to 1.00	Y	Y	0.20	Y	-	N	N	-
R42	Motor/Parameter Switching 2 (Mode selection)	0 : Motor (Switch to the 2nd motor) 1 : Parameter (Switch to particular A codes)	N	Y	0	Y	-	Y	Y	-
R43	Speed Control 2 (Speed command filter)	0.000 to 5.000 s	Y	Y	0.020	N	-	Y	Y	-
R44	(Speed detection filter)	0.000 to 0.100 s	Y*	Y	0.005	N	-	Y	Y	-
R45	P (Gain)	0.1 to 200.0 times	Y*	Y	10.0	N	-	Y	Y	-
R46	I (Integral time)	0.001 to 9.999 s	Y*	Y	0.100	N	Y	Y	Y	N
R48	(Output filter)	0.000 to 0.100 s	Y	Y	0.002	N	-	Y	Y	-
R49	(Notch filter resonance frequency)	1 to 200 Hz	Y	Y	200	N	-	N	Y	-
R50	(Notch filter attenuation level)	0 to 20 dB	Y	Y	0	N	-	N	Y	-
R51	Cumulative Motor Run Time 2	0 to 99990 hours (The cumulative run time can be modified or reset.)	N	N	-	Y	-	Y	Y	-
R52	Startup Counter for Motor 2	Indication of cumulative startup count 0 to 65535 times	Y	N	-	Y	-	Y	Y	-
R53	Motor 2 (%X correction factor 1)	0% to 300%	Y	Y1 Y2	100	Y	-	Y	Y	-
R54	(%X correction factor 2)	0% to 300%	Y	Y1 Y2	100	Y	-	Y	Y	-
R55	(Torque current under vector control)	0.00 to 2000 A	N	Y1 Y2	*7	N	-	Y	Y	-
R56	(Induced voltage factor under vector control)	50 to 100	N	Y1 Y2	85 (90) *8	N	-	Y	Y	-
R57	Reserved *9	-	-	-	-	-	-	-	-	-

*2 The motor rated current is automatically set. See Table B (P03/A17/b17/r17).

*3 5.0 min for inverters of 40 HP or below; 10.0 min for those of 50 HP or above

*4 0% to 100% for inverters of 7.5 HP or below

*7 The motor parameters are automatically set, depending upon the inverter's capacity. See Table B.

*8 85% for inverters of 150 HP or less; 90% for those of 175 HP or above.

*9 Factory use. Do not access these function codes.

●b codes: Motor 3 Parameters

Code	Name	Data setting range	Change when running	Data copying	Default setting	Drive control				
						V/f	PG V/f	w/o PG	w/ PG	Torque Control
b01	Maximum Frequency 3	25.0 to 500.0 Hz	N	Y	60.0	Y	-	Y	Y	-
b02	Base Frequency 3	25.0 to 500.0 Hz	N	Y	60.0	Y	-	Y	Y	-

● b codes: Motor 3 Parameters

Code	Name	Data setting range	Change when running	Data copying	Default setting	Drive control				
						V/f	PG V/f	w/o PG	w/ PG	Torque Control
b03	Rated Voltage at Base Frequency 3	0 : Output a voltage in proportion to input voltage 80 to 240 : Output an AVR-controlled voltage (for 230 V series) 160 to 500 : Output an AVR-controlled voltage (for 460 V series)	N	Y2	230 460	Y	-	Y	Y	-
b04	Maximum Output Voltage 3	80 to 240 : Output an AVR-controlled voltage (for 230 V series) 160 to 500 : Output an AVR-controlled voltage (for 460 V series)	N	Y2	230 460	Y	-	N	N	-
b05	Torque Boost 3	0.0% to 20.0% (percentage with respect to "b03: Rated Voltage at Base Frequency 3")	Y	Y	0.0	Y	-	N	N	-
b06	Electronic Thermal Overload Protection for Motor 3 (Select motor characteristics)	1 : For a general-purpose motor with shaft-driven cooling fan 2 : For an inverter-driven motor, non-ventilated motor, or motor with separately powered cooling fan	Y	Y	1	Y	-	Y	Y	-
b07	(Overload detection level)	0.0: Disable 1% to 135% of the rated current (allowable continuous drive current) of the motor	Y	Y1 Y2	*2	Y	-	Y	Y	-
b08	(Thermal time constant)	0.5 to 75.0 min	Y	Y	*3	Y	-	Y	Y	-
b09	DC Braking 3 (Braking starting frequency)	0.0 to 60.0 Hz	Y	Y	0.0	Y	-	Y	Y	-
b10	(Braking level)	0% to 80% (LD/MD mode)*4, 0% to 100% (HD mode)	Y	Y	0	Y	-	Y	Y	-
b11	(Braking time)	0.00: Disable; 0.01 to 30.00 s	Y	Y	0.00	Y	-	Y	Y	-
b12	Starting Frequency 3	0.0 to 60.0 Hz	Y	Y	0.5	Y	-	Y	Y	-
b13	Load Selection/ Auto Torque Boost/ Auto Energy Saving Operation 3	0 : Variable torque load 1 : Constant torque load 2 : Auto-torque boost 3 : Auto-energy saving operation (Variable torque load during ACC/DEC) 4 : Auto-energy saving operation (Constant torque load during ACC/DEC) 5 : Auto-energy saving operation (Auto-torque boost during ACC/DEC)	N	Y	1	Y	-	N	Y	-
b14	Drive Control Selection 3	0 : V/f control with slip compensation inactive 1 : Dynamic torque vector control 2 : V/f control with slip compensation active 3 : V/f control with speed sensor 4 : Dynamic torque vector control with speed sensor 5 : Vector control without speed sensor 6 : Vector control with speed sensor	N	Y	0	Y	-	Y	Y	-
b15	Motor 3 (No. of poles)	2 to 22 poles	N	Y1 Y2	4	Y	-	Y	Y	-
b16	(Rated capacity)	0.01 to 1000 kW (when b39 = 0, 2, 3 or 4) 0.01 to 1000 HP (when b39 = 1)	N	Y1 Y2	*7	Y	-	Y	Y	-
b17	(Rated current)	0.00 to 2000 A	N	Y1 Y2	*7	Y	-	Y	Y	-
b18	(Auto-tuning)	0 : Disable 1 : Tune while the motor stops. (%R1, %X and rated slip frequency) 2 : Tune while the motor is rotating under V/f control (%R1, %X, rated slip frequency, no-load current, magnetic saturation factors 1 to 5, and magnetic saturation extension factors "a" to "c") 3 : Tune while the motor is rotating under vector control (%R1, %X, rated slip frequency, no-load current, magnetic saturation factors 1 to 5, and magnetic saturation extension factors "a" to "c." Available when the vector control is enabled.)	N	N	0	Y	-	Y	Y	-
b19	Motor 3 (Online tuning)	0 : Disable 1 : Enable	Y	Y	0	Y	N	N	N	N
b20	(No-load current)	0.00 to 2000 A	N	Y1 Y2	*7	Y	-	Y	Y	-
b21	(%R1)	0.00% to 50.00%	Y	Y1 Y2	*7	Y	-	Y	Y	-
b22	(%X)	0.00% to 50.00%	Y	Y1 Y2	*7	Y	-	Y	Y	-
b23	(Slip compensation gain for driving)	0.0% to 200.0%	Y*	Y	100.0	Y	-	Y	Y	-
b24	(Slip compensation response time)	0.01 to 10.00 s	Y	Y1 Y2	0.12	Y	-	N	N	-
b25	(Slip compensation gain for braking)	0.0% to 200.0%	Y*	Y	100.0	Y	-	Y	Y	-
b26	(Rated slip frequency)	0.00 to 15.00 Hz	N	Y1 Y2	*7	Y	-	Y	Y	-
b27	(Iron loss factor 1)	0.00% to 20.00%	Y	Y1 Y2	*7	Y	-	Y	Y	-
b28	(Iron loss factor 2)	0.00% to 20.00%	Y	Y1 Y2	0.00	Y	-	Y	Y	-
b29	(Iron loss factor 3)	0.00% to 20.00%	Y	Y1 Y2	0.00	Y	-	Y	Y	-
b30	(Magnetic saturation factor 1)	0.0% to 300.0%	Y	Y1 Y2	*7	Y	-	Y	Y	-
b31	(Magnetic saturation factor 2)	0.0% to 300.0%	Y	Y1 Y2	*7	Y	-	Y	Y	-
b32	(Magnetic saturation factor 3)	0.0% to 300.0%	Y	Y1 Y2	*7	Y	-	Y	Y	-
b33	(Magnetic saturation factor 4)	0.0% to 300.0%	Y	Y1 Y2	*7	Y	-	Y	Y	-
b34	(Magnetic saturation factor 5)	0.0% to 300.0%	Y	Y1 Y2	*7	Y	-	Y	Y	-
b35	Motor 3 (Magnetic saturation extension factor "a")	0.0% to 300.0%	Y	Y1 Y2	*7	Y	-	Y	Y	-
b36	(Magnetic saturation extension factor "b")	0.0% to 300.0%	Y	Y1 Y2	*7	Y	-	Y	Y	-
b37	(Magnetic saturation extension factor "c")	0.0% to 300.0%	Y	Y1 Y2	*7	Y	-	Y	Y	-
b39	Motor 3 Selection	0 : Motor characteristics 0 (Fuji standard motors, 8-series) 1 : Motor characteristics 1 (HP rating motors) 2 : Motor characteristics 2 (Fuji motors exclusively designed for vector control) 3 : Motor characteristics 3 (Fuji standard motors, 6-series) 4 : Other motors	N	Y1 Y2	1	Y	-	Y	Y	-
b40	Slip Compensation 3 (Operating conditions)	0 : Enable during ACC/DEC and at base frequency or above 1 : Disable during ACC/DEC and enable at base frequency or above 2 : Enable during ACC/DEC and disable at base frequency or above 3 : Disable during ACC/DEC and at base frequency or above	N	Y	0	Y	-	N	N	-
b41	Output Current Fluctuation Damping Gain for Motor 3	0.00 to 1.00	Y	Y	0.20	Y	-	N	N	-
b42	Motor/Parameter Switching 3 (Mode selection)	0 : Motor (Switch to the 3rd motor) 1 : Parameter (Switch to particular b codes)	N	Y	0	Y	-	Y	Y	-
b43	Speed Control 3 (Speed command filter)	0.000 to 5.000 s	Y	Y	0.020	N	-	Y	Y	-
b44	(Speed detection filter)	0.000 to 0.100 s	Y*	Y	0.005	N	-	Y	Y	-
b45	P (Gain)	0.1 to 200.0 times	Y*	Y	10.0	N	-	Y	Y	-
b46	I (Integral time)	0.01 to 9.999 s	Y*	Y	0.100	N	Y	Y	Y	N
b48	(Output filter)	0.000 to 0.100 s	Y	Y	0.002	N	-	Y	Y	-
b49	(Notch filter resonance frequency)	1 to 200 Hz	Y	Y	200	N	-	N	Y	-
b50	(Notch filter attenuation level)	0 to 20 dB	Y	Y	0	N	-	N	Y	-
b51	Cumulative Motor Run Time 3	0 to 99990 hours (The cumulative run time can be modified or reset.)	N	N	-	Y	-	Y	Y	-
b52	Startup Counter for Motor 3	Indication of cumulative startup count 0 to 65535 times	Y	N	-	Y	-	Y	Y	-
b53	Motor 3 (%X correction factor 1)	0% to 300%	Y	Y1 Y2	100	Y	-	Y	Y	-
b54	(%X correction factor 2)	0% to 300%	Y	Y1 Y2	100	Y	-	Y	Y	-
b55	(Torque current under vector control)	0.00 to 2000 A	N	Y1 Y2	*7	N	-	Y	Y	-
b56	(Induced voltage factor under vector control)	50 to 100	N	Y1 Y2	85 (90)*8	N	-	Y	Y	-
b57	Reserved *9	-	-	-	-	-	-	-	-	-

*2 The motor rated current is automatically set. See Table B (P03/A17/b17/r17).

*3 5.0 min for inverters of 40 HP or below; 10.0 min for those of 50 HP or above

*4 0% to 100% for inverters of 7.5 HP or below

*7 The motor parameters are automatically set, depending upon the inverter's capacity. See Table B.

*8 85% for inverters of 150 HP or less; 90% for those of 175 HP or above.

*9 Factory use. Do not access these function codes.

Characteristics
Model Variations
Model Variability
Keypad Functionality
Inverter PC Softw
Standard Specifications
Common Specifications
Basic Wiring Diagram
Terminal Functions
Function Settings
External Dimensions
Options
Reference material
Warranty

Function Settings

Function Settings

Codes: Motor 4 Parameters

Code	Name	Data setting range	Change when running	Data copying	Default setting	Drive control				
						V/f	PG V/f	w/o PG	w/ PG	Torque Control
r01	Maximum Frequency 4	25.0 to 500.0 Hz	N	Y	60.0	Y	-	Y	Y	-
r02	Base Frequency 4	25.0 to 500.0 Hz	N	Y	60.0	Y	-	Y	Y	-
r03	Rated Voltage at Base Frequency 4	0 : Output a voltage in proportion to input voltage 80 to 240 : Output an AVR-controlled voltage (for 230 V series) 160 to 500 : Output an AVR-controlled voltage (for 460 V series)	N	Y2	230 460	Y	-	Y	Y	-
r04	Maximum Output Voltage 4	80 to 240 : Output an AVR-controlled voltage (for 230 V series) 160 to 500 : Output an AVR-controlled voltage (for 460 V series)	N	Y2	230 460	Y	-	N	N	-
r05	Torque Boost 4	0.0% to 20.0% (percentage with respect to "r03: Rated Voltage at Base Frequency 4")	Y	Y	0.0	Y	-	N	N	-
r06	Electronic Thermal Overload Protection for Motor 4 (Select motor characteristics)	1 : For a general-purpose motor with shaft-driven cooling fan 2 : For an inverter-driven motor, non-ventilated motor, or motor with separately powered cooling fan	Y	Y	1	Y	-	Y	Y	-
r07	(Overload detection level)	0.00: Disable 1% to 135% of the rated current (allowable continuous drive current) of the motor	Y	Y1 Y2	*2	Y	-	Y	Y	-
r08	(Thermal time constant)	0.5 to 75.0 min	Y	Y	*3	Y	-	Y	Y	-
r09	DC Braking 4 (Braking starting frequency)	0.0 to 60.0 Hz	Y	Y	0.0	Y	-	Y	Y	-
r10	(Braking level)	0% to 80% (LD/MD mode)*4, 0% to 100% (HD mode)	Y	Y	0	Y	-	Y	Y	-
r11	(Braking time)	0.00: Disable; 0.01 to 30.00 s	Y	Y	0.00	Y	-	Y	Y	-
r12	Starting Frequency 4	0.0 to 60.0 Hz	Y	Y	0.5	Y	-	Y	Y	-
r13	Load Selection/ Auto Torque Boost/ Auto Energy Saving Operation 4	0 : Variable torque load 1 : Constant torque load 2 : Auto-torque boost 3 : Auto-energy saving operation (Variable torque load during ACC/DEC) 4 : Auto-energy saving operation (Constant torque load during ACC/DEC) 5 : Auto-energy saving operation (Auto-torque boost during ACC/DEC)	N	Y	1	Y	-	N	Y	-
r14	Drive Control Selection 4	0 : V/f control with slip compensation inactive 1 : Dynamic torque vector control 2 : V/f control with slip compensation active 3 : V/f control with speed sensor 4 : Dynamic torque vector control with speed sensor 5 : Vector control without speed sensor 6 : Vector control with speed sensor	N	Y	0	Y	-	Y	Y	-
r15	Motor 4 (No. of poles)	2 to 22 poles	N	Y1 Y2	4	Y	-	Y	Y	-
r16	(Rated capacity)	0.01 to 1000 kW (when r39 = 0, 2, 3 or 4) 0.01 to 1000 HP (when r39 = 1)	N	Y1 Y2	*7	Y	-	Y	Y	-
r17	(Rated current)	0.00 to 2000 A	N	Y1 Y2	*7	Y	-	Y	Y	-
r18	(Auto-tuning)	0 : Disable 1 : Tune while the motor stops. (%R1, %X and rated slip frequency) 2 : Tune while the motor is rotating under V/f control (%R1, %X, rated slip frequency, no-load current, magnetic saturation factors 1 to 5, and magnetic saturation extension factors "a" to "c") 3 : Tune while the motor is rotating under vector control (%R1, %X, rated slip frequency, no-load current, magnetic saturation factors 1 to 5, and magnetic saturation extension factors "a" to "c." Available when the vector control is enabled.)	N	N	0	Y	-	Y	Y	-
r19	Motor 4 (Online tuning)	0 : Disable 1 : Enable	Y	Y	0	Y	N	N	N	N
r20	(No-load current)	0.00 to 2000 A	N	Y1 Y2	*7	Y	-	Y	Y	-
r21	(%R1)	0.00% to 50.00%	Y	Y1 Y2	*7	Y	-	Y	Y	-
r22	(%X)	0.00% to 50.00%	Y	Y1 Y2	*7	Y	-	Y	Y	-
r23	(Slip compensation gain for driving)	0.0% to 200.0%	Y*	Y	100.0	Y	-	Y	Y	-
r24	(Slip compensation response time)	0.01 to 10.00 s	Y	Y1 Y2	0.12	Y	-	N	N	-
r25	(Slip compensation gain for braking)	0.0% to 200.0%	Y*	Y	100.0	Y	-	Y	Y	-
r26	(Rated slip frequency)	0.00 to 15.00 Hz	N	Y1 Y2	*7	Y	-	Y	Y	-
r27	(Iron loss factor 1)	0.00% to 20.00%	Y	Y1 Y2	*7	Y	-	Y	Y	-
r28	(Iron loss factor 2)	0.00% to 20.00%	Y	Y1 Y2	0.00	Y	-	Y	Y	-
r29	(Iron loss factor 3)	0.00% to 20.00%	Y	Y1 Y2	0.00	Y	-	Y	Y	-
r30	(Magnetic saturation factor 1)	0.0% to 300.0%	Y	Y1 Y2	*7	Y	-	Y	Y	-
r31	(Magnetic saturation factor 2)	0.0% to 300.0%	Y	Y1 Y2	*7	Y	-	Y	Y	-
r32	(Magnetic saturation factor 3)	0.0% to 300.0%	Y	Y1 Y2	*7	Y	-	Y	Y	-
r33	(Magnetic saturation factor 4)	0.0% to 300.0%	Y	Y1 Y2	*7	Y	-	Y	Y	-
r34	(Magnetic saturation factor 5)	0.0% to 300.0%	Y	Y1 Y2	*7	Y	-	Y	Y	-
r35	(Magnetic saturation extension factor "a")	0.0% to 300.0%	Y	Y1 Y2	*7	Y	-	Y	Y	-
r36	(Magnetic saturation extension factor "b")	0.0% to 300.0%	Y	Y1 Y2	*7	Y	-	Y	Y	-
r37	(Magnetic saturation extension factor "c")	0.0% to 300.0%	Y	Y1 Y2	*7	Y	-	Y	Y	-
r39	Motor 4 Selection	0 : Motor characteristics 0 (Fuji standard motors, 8-series) 1 : Motor characteristics 1 (HP rating motors) 2 : Motor characteristics 2 (Fuji motors exclusively designed for vector control) 3 : Motor characteristics 3 (Fuji standard motors, 6-series) 4 : Other motors	N	Y1 Y2	1	Y	-	Y	Y	-
r40	Slip Compensation 4 (Operating conditions)	0 : Enable during ACC/DEC and at base frequency or above 1 : Disable during ACC/DEC and enable at base frequency or above 2 : Enable during ACC/DEC and disable at base frequency or above 3 : Disable during ACC/DEC and at base frequency or above	N	Y	0	Y	-	N	N	-
r41	Output Current Fluctuation Damping Gain for Motor 4	0.00 to 1.00	Y	Y	0.20	Y	-	N	N	-
r42	Motor/Parameter Switching 4 (Mode selection)	0 : Motor (Switch to the 4th motor) 1 : Parameter (Switch to particular r codes)	N	Y	0	Y	-	Y	Y	-
r43	Speed Control 4 (Speed command filter)	0.000 to 5.000 s	Y	Y	0.020	N	-	Y	Y	-
r44	(Speed detection filter)	0.000 to 0.100 s	Y*	Y	0.005	N	-	Y	Y	-
r45	P (Gain)	0.1 to 200.0 times	Y*	Y	10.0	N	-	Y	Y	-
r46	I (Integral time)	0.01 to 9.999 s	Y*	Y	0.100	N	Y	Y	Y	N
r48	(Output filter)	0.000 to 0.100 s	Y	Y	0.002	N	-	Y	Y	-
r49	(Notch filter resonance frequency)	1 to 200 Hz	Y	Y	200	N	-	N	Y	-
r50	(Notch filter attenuation level)	0 to 20 dB	Y	Y	0	N	-	N	Y	-
r51	Cumulative Motor Run Time 4	0 to 99990 hours (The cumulative run time can be modified or reset.)	N	N	-	Y	-	Y	Y	-
r52	Startup Counter for Motor 4	Indication of cumulative startup count 0 to 65535 times	Y	N	-	Y	-	Y	Y	-
r53	Motor 4 (%X correction factor 1)	0% to 300%	Y	Y1 Y2	100	Y	-	Y	Y	-
r54	(%X correction factor 2)	0% to 300%	Y	Y1 Y2	100	Y	-	Y	Y	-
r55	(Torque current under vector control)	0.00 to 2000 A	N	Y1 Y2	*7	N	-	Y	Y	-

●r codes: Motor 4 Parameters

Code	Name	Data setting range	Change when running	Data copying	Default setting	Drive control				
						V/f	PG V/f	w/o PG	w/ PG	Torque Control
r56	Motor 4 (Induced voltage factor under vector control)	50 to 100	N	Y1 Y2	85(90)*8	N	-	Y	Y	-
r57	Reserved *9	--	-	-	-	-	-	-	-	-

*2 The motor rated current is automatically set. See Table B (P03/A17/b17/r17).
 *3 5.0 min for inverters of 40 HP or below; 10.0 min for those of 50 HP or above
 *4 0% to 100% for inverters of 7.5 HP or below
 *7 The motor parameters are automatically set, depending upon the inverter's capacity. See Table B.
 *8 85% for inverters of 150 HP or less; 90% for those of 175 HP or above.
 *9 Factory use. Do not access these function codes.

●J codes: Application Functions 1

Code	Name	Data setting range	Change when running	Data copying	Default setting	Drive control				
						V/f	PG V/f	w/o PG	w/ PG	Torque Control
J01	PID Control (Mode selection)	0 : Disable 1 : Enable (Process control, normal operation) 2 : Enable (Process control, inverse operation) 3 : Enable (Dancer control)	N	Y	0	Y	-	Y	Y	-
J02	(Remote command SV)	0 : keys on keypad 1 : PID command 1 (Analog input terminals [12], [C1], and [V2]) 3 : UP/DOWN 4 : Command via communications link	N	Y	0	Y	-	Y	Y	-
J03	P (Gain)	0.000 to 30.000 times	Y	Y	0.100	Y	-	Y	Y	-
J04	I (Integral time)	0.0 to 3600.0 s	Y	Y	0.0	Y	-	Y	Y	-
J05	D (Differential time)	0.00 to 600.00 s	Y	Y	0.00	Y	-	Y	Y	-
J06	(Feedback filter)	0.0 to 900.0 s	Y	Y	0.5	Y	-	Y	Y	-
J08	(Pressurization starting frequency)	0.0 to 500.0 Hz	Y	Y	0.0	Y	-	Y	Y	-
J09	(Pressurizing time)	0 to 60 s	Y	Y	0	Y	-	Y	Y	-
J10	(Anti reset windup)	0% to 200%	Y	Y	200	Y	-	Y	Y	-
J11	(Select alarm output)	0 : Absolute-value alarm 1 : Absolute-value alarm (with Hold) 2 : Absolute-value alarm (with Latch) 3 : Absolute-value alarm (with Hold and Latch) 4 : Deviation alarm 5 : Deviation alarm (with Hold) 6 : Deviation alarm (with Latch) 7 : Deviation alarm (with Hold and Latch)	Y	Y	0	Y	-	Y	Y	-
J12	(Upper level alarm (AH))	-100% to 100%	Y	Y	100	Y	-	Y	Y	-
J13	(Lower level alarm (AL))	-100% to 100%	Y	Y	0	Y	-	Y	Y	-
J15	(Stop frequency for slow flowrate)	0.0: Disable; 1.0 to 500.0 Hz	Y	Y	0.0	Y	-	Y	Y	-
J16	(Slow flowrate level stop latency)	0 to 60 s	Y	Y	30	Y	-	Y	Y	-
J17	(Starting frequency)	0.0 to 500.0 Hz	Y	Y	0.0	Y	-	Y	Y	-
J18	(Upper limit of PID process output)	-150% to 150%; 999: Depends on setting of F15	Y	Y	999	Y	-	Y	Y	-
J19	(Lower limit of PID process output)	-150% to 150%; 999: Depends on setting of F16	Y	Y	999	Y	-	Y	Y	-
J21	Dew Condensation Prevention (Duty)	1% to 50%	Y	Y	1	Y	-	Y	Y	-
J22	Commercial Power Switching Sequence	0 : Keep inverter operation (Stop due to alarm) 1 : Automatically switch to commercial-power operation	N	Y	0	Y	-	N	N	-
J56	PID Control (Speed command filter)	0.00 to 5.00 s	Y	Y	0.10	Y	-	Y	Y	-
J57	(Dancer reference position)	-100% to 0% to 100%	Y	Y	0	Y	-	Y	Y	-
J58	(Detection width of dancer position deviation)	0 : Disable switching PID constant 1% to 100% (Manually set value)	Y	Y	0	Y	-	Y	Y	-
J59	P (Gain) 2	0.000 to 30.000 times	Y	Y	0.100	Y	-	Y	Y	-
J60	I (Integral time) 2	0.0 to 3600.0 s	Y	Y	0.0	Y	-	Y	Y	-
J61	D (Differential time) 2	0.00 to 600.00 s	Y	Y	0.00	Y	-	Y	Y	-
J62	(PID control block selection)	0 to 3 bit 0 : PID output polarity 0 : Plus (add), 1 : Minus (subtract) bit 1 : Select compensation factor for PID output 0 = Ratio (relative to the main setting) 1 = Speed command (relative to maximum frequency)	N	Y	0	Y	-	Y	Y	-
J68	Brake Signal (Brake-OFF current)	0% to 300%	Y	Y	100	Y	-	Y	Y	-
J69	(Brake-OFF frequency/speed)	0.0 to 25.0 Hz	Y	Y	1.0	Y	-	N	N	-
J70	(Brake-OFF timer)	0.0 to 5.0 s	Y	Y	1.0	Y	-	Y	Y	-
J71	(Brake-ON frequency/speed)	0.0 to 25.0 Hz	Y	Y	1.0	Y	-	N	N	-
J72	(Brake-ON timer)	0.0 to 5.0 s	Y	Y	1.0	Y	-	Y	Y	-
J95	(Brake-OFF torque)	0% to 300%	Y	Y	100	N	-	Y	Y	-
J96	Brake Signal (Speed condition selection)	0 to 31 Bit 0 : Criterion speed for brake-ON (0 : Detected speed, 1 : Reference speed) Bit 1 : Reserved Bit 2 : Response for brake-OFF current (0 : Slow response, 1 : Quick response) Bit 3 : Criterion frequency for brake-ON (0 : Stop frequency (F25), 1 : Brake-ON frequency (J71)) Bit 4 : Output condition of brake signal (0 : Independent of a run command ON/OFF, 1 : Only when a run command is OFF)	N	Y	0	N	N	Y	Y	N
J97	Servo-lock (Gain)	0.00 to 10.00 times	Y*	Y	0.10	N	-	N	Y	-
J98	(Completion timer)	0.000 to 1.000 s	Y	Y	0.100	N	-	N	Y	-
J99	(Completion range)	0 to 9999 pulses	Y	Y	10	N	-	N	Y	-

Function Settings

Function Settings

●d codes: Application Functions 2

Code	Name	Data setting range	Change when running	Data copying	Default setting	Drive control				
						V/f	PG V/f	w/o PG	w/ PG	Torque Control
d01	Speed Control 1 (Speed command filter)	0.000 to 5.000 s	Y	Y	0.020	N	-	Y	Y	-
d02	(Speed detection filter)	0.000 to 0.100 s	Y*	Y	0.005	N	-	Y	Y	-
d03	P (Gain)	0.1 to 200.0 times	Y*	Y	10.0	N	-	Y	Y	-
d04	I (Integral time)	0.001 to 9.999 s	Y*	Y	0.100	N	Y	Y	Y	N
d05	(Output filter)	0.000 to 0.100 s	Y	Y	0.002	N	-	Y	Y	-
d07	(Notch filter resonance frequency)	1 to 200 Hz	Y	Y	200	N	-	N	Y	-
d08	(Notch filter attenuation level)	0 to 20 dB	Y	Y	0	N	-	N	Y	-
d09	Speed Control (Jogging) (Speed command filter)	0.000 to 5.000 s	Y	Y	0.020	N	-	Y	Y	-
d10	(Speed detection filter)	0.000 to 0.100 s	Y*	Y	0.005	N	-	Y	Y	-
d11	P (Gain)	0.1 to 200.0 times	Y*	Y	10.0	N	-	Y	Y	-
d12	I (Integral time)	0.001 to 9.999 s	Y*	Y	0.100	N	-	Y	Y	-
d13	(Output filter)	0.000 to 0.100 s	Y	Y	0.002	N	-	Y	Y	-
d14	Feedback Input (Pulse input format)	0 : Pulse train sign/Pulse train input 1 : Forward rotation pulse/Reverse rotation pulse 2 : A/B phase with 90 degree phase shift	N	Y	2	N	-	N	Y	-
d15	(Encoder pulse resolution)	20 to 60000 pulses	N	Y	1024	N	-	N	Y	-
d16	(Pulse count factor 1)	1 to 9999	N	Y	1	N	-	N	Y	-
d17	(Pulse count factor 2)	1 to 9999	N	Y	1	N	-	N	Y	-
d21	Speed Agreement/PG Error (Hysteresis width)	0.0% to 50.0%	Y	Y	10.0	N	-	Y	Y	-
d22	(Detection timer)	0.00 to 10.00 s	Y	Y	0.50	N	-	Y	Y	-
d23	PG Error Processing	0 : Continue to run 1 1 : Stop running with alarm 1 2 : Stop running with alarm 2 3 : Continue to run 2 4 : Stop running with alarm 3 5 : Stop running with alarm 4	N	Y	2	N	-	Y	Y	-
d24	Zero Speed Control	0 : Not permit at startup 1 : Permit at startup	N	Y	0	N	-	Y	Y	-
d25	ASR Switching Time	0.000 to 1.000 s	Y	Y	0.000	N	-	Y	Y	-
d32	Torque Control (Speed limit 1)	0 to 110 %	Y	Y	100	N	-	Y	Y	-
d33	(Speed limit 2)	0 to 110 %	Y	Y	100	N	-	Y	Y	-
d41	Application-defined Control	0 : Disable (Ordinary control) 1 : Enable (Constant peripheral speed control) 2 : Enable (Simultaneous synchronization, without Z phase) 3 : Enable (Standby synchronization) 4 : Enable (Simultaneous synchronization, with Z phase)	N	Y	0	Y	-	Y	Y	-
d51	Reserved *9	-	-	-	-	-	-	-	-	-
d52	Reserved *9	-	-	-	-	-	-	-	-	-
d53	Reserved *9	-	-	-	-	-	-	-	-	-
d54	Reserved *9	-	-	-	-	-	-	-	-	-
d55	Reserved *9	-	-	-	-	-	-	-	-	-
d59	Command (Pulse Rate Input) (Pulse input format)	0 : Pulse train sign/Pulse train input 1 : Forward rotation pulse/Reverse rotation pulse 2 : A/B phase with 90 degree phase shift	N	Y	0	Y	-	Y	Y	-
d60	(Encoder pulse resolution)	20 to 3600 pulses	N	Y	1024	N	-	N	Y	-
d61	(Filter time constant)	0.000 to 5.000 s	Y	Y	0.005	Y	-	Y	Y	-
d62	(Pulse count factor 1)	1 to 9999	N	Y	1	Y	-	Y	Y	-
d63	(Pulse count factor 2)	1 to 9999	N	Y	1	Y	-	Y	Y	-
d67	Starting Mode (Auto search)	0 : Disable 1 : Enable (At restart after momentary power failure) 2 : Enable (At restart after momentary power failure and at normal start)	N	Y	2	N	-	Y	N	-
d68	Reserved *9	-	-	-	-	-	-	-	-	-
d69	Reserved *9	-	-	-	-	-	-	-	-	-
d70	Speed Control Limiter	0.00 to 100.00%	Y	Y	100.00	N	-	N	Y	-
d71	Synchronous Operation (Main speed regulator gain)	0.00 to 1.50 times	Y	Y	1.00	N	-	N	Y	-
d72	(APR P gain)	0.00 to 200.00 times	Y	Y	1500	N	-	N	Y	-
d73	(APR positive output limiter)	20 to 200%, 999: No limiter	Y	Y	999	N	-	N	Y	-
d74	(APR negative output limiter)	20 to 200%, 999: No limiter	Y	Y	999	N	-	N	Y	-
d75	(Z phase alignment gain)	0.00 to 10.00 times	Y	Y	1.00	N	-	N	Y	-
d76	(Synchronous offset angle)	0 to 359 degrees	Y	Y	0	N	-	N	Y	-
d77	(Synchronization completion detection angle)	0 to 100 degrees	Y	Y	15	N	-	N	Y	-
d78	(Excessive deviation detection range)	0 to 65535 (in units of 10 pulses)	Y	Y	65535	N	-	N	Y	-
d98	Reserved *9	-	-	-	-	-	-	-	-	-
d99	Reserved *9	-	-	-	-	-	-	-	-	-

*9 Factory use. Do not access these function codes.

● U codes: Application Functions 3

Code	Name	Data setting range	Change when running	Data copying	Default setting	Drive control				
						V/f	PG V/f	w/o PG	w/ PG	Torque Control
U00	Customizable Logic (Mode selection)	0 : Disable 1 : Enable (Customizable logic operation)	N	Y	Y	Y	-	Y	Y	-
U01	Customizable Logic: (Input 1)	0 (1000): Inverter running (RUN)	N	Y	Y	Y	-	Y	Y	-
U02	Step 1 (Input 2)	1 (1001): Frequency (speed) arrival signal (FAR)	N	Y	Y	Y	-	Y	Y	-
		2 (1002): Frequency (speed) detected (FDT)				Y	-	Y	Y	-
		3 (1003): Undervoltage detected (Inverter stopped) (LU)				Y	-	Y	Y	-
		4 (1004): Torque polarity detected (B/D)				Y	-	Y	Y	-
		5 (1005): Inverter output limiting (IOL)				Y	-	Y	Y	-
		6 (1006): Auto-restarting after momentary power failure (IPF)				Y	-	Y	Y	-
		7 (1007): Motor overload early warning (OL)				Y	-	Y	Y	-
		8 (1008): Keypad operation enabled (KP)				Y	-	Y	Y	-
		10 (1010): Inverter ready to run (RDY)				Y	-	Y	Y	-
		11 : Switch motor drive source between commercial power and inverter output (For MC on commercial line) (SW88)				Y	-	N	N	-
		12 : Switch motor drive source between commercial power and inverter output (For secondary side) (SW52-2)				Y	-	N	N	-
		13 : Switch motor drive source between commercial power and inverter output (For primary side) (SW52-1)				Y	-	N	N	-
		15 (1015): Select AX terminal function (For MC on primary side) (AX)				Y	-	Y	Y	-
		22 (1022): Inverter output limiting with delay (IOL2)				Y	-	Y	Y	-
		25 (1025): Cooling fan in operation (FAN)				Y	-	Y	Y	-
		26 (1026): Auto-resetting (TRY)				Y	-	Y	Y	-
		28 (1028): Heat sink overheat early warning (OH)				Y	-	Y	Y	-
		29 (1029): Synchronization completed (SY)				N	-	N	Y	-
		30 (1030): Lifetime alarm (LIFE)				Y	-	Y	Y	-
		31 (1031): Frequency (speed) detected 2 (FDT2)				Y	-	Y	Y	-
		33 (1033): Reference loss detected (REF OFF)				Y	-	Y	Y	-
		35 (1035): Inverter output on (RUN2)				Y	-	Y	Y	-
		36 (1036): Overload prevention control (OLP)				Y	-	Y	Y	-
		37 (1037): Current detected (ID)				Y	-	Y	Y	-
		38 (1038): Current detected 2 (ID2)				Y	-	Y	Y	-
		39 (1039): Current detected 3 (ID3)				Y	-	Y	Y	-
		41 (1041): Low current detected (IDL)				Y	-	Y	Y	-
		42 (1042): PID alarm (PID-ALM)				Y	-	Y	Y	-
		43 (1043): Under PID control (PID-CTL)				Y	-	Y	Y	-
		44 (1044): Motor stopped due to slow flowrate under PID control (PID-STP)				Y	-	Y	Y	-
		45 (1045): Low output torque detected (U-TL)				Y	-	Y	Y	-
		46 (1046): Torque detected 1 (TD1)				Y	-	Y	Y	-
		47 (1047): Torque detected 2 (TD2)				Y	-	Y	Y	-
		48 (1048): Motor 1 selected (SWM1)				Y	-	Y	Y	-
		49 (1049): Motor 2 selected (SWM2)				Y	-	Y	Y	-
		50 (1050): Motor 3 selected (SWM3)				Y	-	Y	Y	-
		51 (1051): Motor 4 selected (SWM4)				Y	-	Y	Y	-
		52 (1052): Running forward (FRUN)				Y	-	Y	Y	-
		53 (1053): Running reverse (RRUN)				Y	-	Y	Y	-
		54 (1054): In remote operation (RMT)				Y	-	Y	Y	-
		56 (1056): Motor overheat detected by thermistor (THM)				Y	-	Y	Y	-
		57 (1057): Brake signal (BRKS)				Y	-	Y	Y	-
		58 (1058): Frequency (speed) detected 3 (FDT3)				Y	-	Y	Y	-
		59 (1059): Terminal [C1] wire break (C1OFF)				Y	-	Y	Y	-
		70 (1070): Speed valid (DNZS)				N	-	Y	Y	-
		71 (1071): Speed agreement (DSAG)				N	-	Y	Y	-
		72 (1072): Frequency (speed) arrival signal 3 (FAR3)				Y	-	Y	Y	-
		76 (1076): PG error detected (PG-ERR)				N	-	Y	Y	-
		82 (1082): Positioning completion signal (PSET)				N	-	N	Y	-
		84 (1084): Maintenance timer (MNT)				Y	-	Y	Y	-
		98 (1098): Light alarm (L-ALM)				Y	-	Y	Y	-
		99 (1099): Alarm output (for any alarm) (ALM)				Y	-	Y	Y	-
		101 (1101): Enable circuit failure detected (DECF)				Y	-	Y	Y	-
		102 (1102): Enable input OFF (EN OFF)				Y	-	Y	Y	-
		105 (1105): Braking transistor broken (DBAL)				Y	-	Y	Y	-
		2001 (3001): Output of step 1 (SO01)				Y	-	Y	Y	-
		2002 (3002): Output of step 2 (SO02)				Y	-	Y	Y	-
		2003 (3003): Output of step 3 (SO03)				Y	-	Y	Y	-
		2004 (3004): Output of step 4 (SO04)				Y	-	Y	Y	-
		2005 (3005): Output of step 5 (SO05)				Y	-	Y	Y	-
		2006 (3006): Output of step 6 (SO06)				Y	-	Y	Y	-
		2007 (3007): Output of step 7 (SO07)				Y	-	Y	Y	-
		2008 (3008): Output of step 8 (SO08)				Y	-	Y	Y	-
		2009 (3009): Output of step 9 (SO09)				Y	-	Y	Y	-
		2010 (3010): Output of step 10 (SO10)				Y	-	Y	Y	-
		4001 (5001): Terminal [X1] input signal (X1)				Y	-	Y	Y	-
		4002 (5002): Terminal [X2] input signal (X2)				Y	-	Y	Y	-
		4003 (5003): Terminal [X3] input signal (X3)				Y	-	Y	Y	-
		4004 (5004): Terminal [X4] input signal (X4)				Y	-	Y	Y	-
		4005 (5005): Terminal [X5] input signal (X5)				Y	-	Y	Y	-
		4006 (5006): Terminal [X6] input signal (X6)				Y	-	Y	Y	-
		4007 (5007): Terminal [X7] input signal (X7)				Y	-	Y	Y	-
		4010 (5010): Terminal [FWD] input signal (FWD)				Y	-	Y	Y	-
		4011 (5011): Terminal [REV] input signal (REV)				Y	-	Y	Y	-
		6000 (7000): Final run command (FL_RUN)				Y	-	Y	Y	-
		6001 (7001): Final FWD run command (FL_FWD)				Y	-	Y	Y	-
		6002 (7002): Final REV run command (FL_REV)				Y	-	Y	Y	-
		6003 (7003): During acceleration (DACC)				Y	-	Y	Y	-

Characteristics
Model Variations
Keypad Functionality
Inverter PC Softw
Standard Specifications
Common Specifications
Basic Wiring Diagram
Terminal Functions
Function Settings
External Dimensions
Options
Reference material
Warranty

Function Settings

Function Settings

U codes: Application Functions 3

Code	Name	Data setting range	Change when running	Data copying	Default setting	Drive control		
						V/f	w/o PG	w/ PG
U02	Customizable Logic: Step 1 (Input 2)	6004 (7004) : During deceleration (DDEC) 6005 (7005) : Under anti-regenerative control (REGA) 6006 (7006) : Within dancer reference position (DR_REF) 6007 (7007) : Alarm factor presence (ALM_ACT) Setting the value in parentheses () shown above assigns a negative logic output to a terminal. (True if OFF).				Y	Y	Y
U03	(Logic circuit)	0 : No function assigned 1 : Through output + General-purpose timer 2 : ANDing + General-purpose timer 3 : ORing + General-purpose timer 4 : XORing + General-purpose timer 5 : Set priority flip-flop + General-purpose timer 6 : Reset priority flip-flop + General-purpose timer 7 : Rising edge detector + General-purpose timer 8 : Falling edge detector + General-purpose timer 9 : Rising and falling edge detector + General-purpose timer 10 : Input hold + General-purpose timer 11 : Increment counter 12 : Decrement counter 13 : Timer with reset input	N	Y	0	Y	Y	Y
U04	(Type of timer)	0 : No timer 1 : On-delay timer 2 : Off-delay timer 3 : Pulse 4 : Retriggerable timer 5 : Pulse train output	N	Y	0	Y	Y	Y
U05	(Timer)	0.00 to 600.00	N	Y	0.00	Y	Y	Y
U06	Customizable Logic: (Input 1)	See U01.	N	Y	0	See U01.		
U07	Step 2 (Input 2)	See U02.	N	Y	0	See U02.		
U08	(Logic circuit)	See U03.	N	Y	0	Y	Y	Y
U09	(Type of timer)	See U04.	N	Y	0	Y	Y	Y
U10	(Timer)	See U05.	N	Y	0.00	Y	Y	Y
U11	Customizable Logic: (Input 1)	See U01.	N	Y	0	See U01.		
U12	Step 3 (Input 2)	See U02.	N	Y	0	See U02.		
U13	(Logic circuit)	See U03.	N	Y	0	Y	Y	Y
U14	(Type of timer)	See U04.	N	Y	0	Y	Y	Y
U15	(Timer)	See U05.	N	Y	0.00	Y	Y	Y
U16	Customizable Logic: (Input 1)	See U01.	N	Y	0	See U01.		
U17	Step 4 (Input 2)	See U02.	N	Y	0	See U02.		
U18	(Logic circuit)	See U03.	N	Y	0	Y	Y	Y
U19	(Type of timer)	See U04.	N	Y	0	Y	Y	Y
U20	(Timer)	See U05.	N	Y	0.00	Y	Y	Y
U21	Customizable Logic: (Input 1)	See U01.	N	Y	0	See U01.		
U22	Step 5 (Input 2)	See U02.	N	Y	0	See U02.		
U23	(Logic circuit)	See U03.	N	Y	0	Y	Y	Y
U24	(Type of timer)	See U04.	N	Y	0	Y	Y	Y
U25	(Timer)	See U05.	N	Y	0.00	Y	Y	Y
U26	Customizable Logic: (Input 1)	See U01.	N	Y	0	See U01.		
U27	Step 6 (Input 2)	See U02.	N	Y	0	See U02.		
U28	(Logic circuit)	See U03.	N	Y	0	Y	Y	Y
U29	(Type of timer)	See U04.	N	Y	0	Y	Y	Y
U30	(Timer)	See U05.	N	Y	0.00	Y	Y	Y
U31	Customizable Logic: (Input 1)	See U01.	N	Y	0	See U01.		
U32	Step 7 (Input 2)	See U02.	N	Y	0	See U02.		
U33	(Logic circuit)	See U03.	N	Y	0	Y	Y	Y
U34	(Type of timer)	See U04.	N	Y	0	Y	Y	Y
U35	(Timer)	See U05.	N	Y	0.00	Y	Y	Y
U36	Customizable Logic: (Input 1)	See U01.	N	Y	0	See U01.		
U37	Step 8 (Input 2)	See U02.	N	Y	0	See U02.		
U38	(Logic circuit)	See U03.	N	Y	0	Y	Y	Y
U39	(Type of timer)	See U04.	N	Y	0	Y	Y	Y
U40	(Timer)	See U05.	N	Y	0.00	Y	Y	Y
U41	Customizable Logic: (Input 1)	See U01.	N	Y	0	See U01.		
U42	Step 9 (Input 2)	See U02.	N	Y	0	See U02.		
U43	(Logic circuit)	See U03.	N	Y	0	Y	Y	Y
U44	(Type of timer)	See U04.	N	Y	0	Y	Y	Y
U45	(Timer)	See U05.	N	Y	0.00	Y	Y	Y
U46	Customizable Logic: (Input 1)	See U01.	N	Y	0	See U01.		
U47	Step 10 (Input 2)	See U02.	N	Y	0	See U02.		
U48	(Logic circuit)	See U03.	N	Y	0	Y	Y	Y
U49	(Type of timer)	See U04.	N	Y	0	Y	Y	Y
U50	(Timer)	See U05.	N	Y	0.00	Y	Y	Y
U71	Customizable Logic Output Signal 1 (Output selection)	0 : Disable 1 : Step 1 output (SO01)	N	Y	0	Y	Y	Y
U72	Customizable Logic Output Signal 2	2 : Step 2 output (SO02)	N	Y	0	Y	Y	Y
U73	Customizable Logic Output Signal 3	3 : Step 3 output (SO03)	N	Y	0	Y	Y	Y
U74	Customizable Logic Output Signal 4	4 : Step 4 output (SO04)	N	Y	0	Y	Y	Y
U75	Customizable Logic Output Signal 5	5 : Step 5 output (SO05) 6 : Step 6 output (SO06) 7 : Step 7 output (SO07) 8 : Step 8 output (SO08) 9 : Step 9 output (SO09) 10 : Step 10 output (SO10)	N	Y	0	Y	Y	Y

●U codes: Application Functions 3

Code	Name	Data setting range	Change when running	Data copying	Default setting	Drive control				
						V/f	w/o PG	w/ PG		
<u>U81</u>	Customizable Logic Output Signal 1 (Function selection)	0 (1000): Select multi-frequency (0 to 1 step) (SS1)	N	Y	100	Y	Y	Y		
		1 (1001): Select multi-frequency (0 to 3 steps) (SS2)				Y	Y	Y		
		2 (1002): Select multi-frequency (0 to 7 steps) (SS4)	N	Y	100	Y	Y	Y		
		3 (1003): Select multi-frequency (0 to 15 steps) (SS8)	N	Y	100	Y	Y	Y		
		4 (1004): Select ACC/DEC time (2 steps) (RT1)	N	Y	100	Y	Y	Y		
		5 (1005): Select ACC/DEC time (4 steps) (RT2)	N	Y	100	Y	Y	Y		
		6 (1006): Enable 3-wire operation (HLD)				Y	Y	Y		
		7 (1007): Coast to a stop (BX)				Y	Y	Y		
		8 (1008): Reset alarm (RST)				Y	Y	Y		
		9 (1009): Enable external alarm trip (9 = Active OFF, 1009 = Active ON) (THR)				Y	Y	Y		
		10 (1010): Ready for jogging (JOG)				Y	Y	Y		
		11 (1011): Select frequency command 2/1 (Hz2/Hz1)				Y	Y	Y		
		12 (1012): Select motor 2 (M2)				Y	Y	Y		
		13: Enable DC braking (DCBRK)				Y	Y	Y		
		14 (1014): Select torque limiter level 2/1 (TL2/TL1)				Y	Y	Y		
		15: Switch to commercial power (50 Hz) (SW50)				Y	N	N		
		16: Switch to commercial power (60 Hz) (SW60)				Y	N	N		
		17 (1017): UP (Increase output frequency) (UP)				Y	Y	Y		
		18 (1018): DOWN (Decrease output frequency) (DOWN)				Y	Y	Y		
		20 (1020): Cancel PID control (Hz/PID)				Y	Y	Y		
		21 (1021): Switch normal/inverse operation (IVS)				Y	Y	Y		
		22 (1022): Interlock (IL)				Y	Y	Y		
		23 (1023): Cancel torque control (Hz/TRQ)				N	N	N		
		24 (1024): Enable communications link via RS-485 or fieldbus (LE)				Y	Y	Y		
		25 (1025): Universal DI (U-DI)				Y	Y	Y		
		26 (1026): Enable auto search for idling motor speed at starting (STM)				Y	Y	N		
		30 (1030): Force to stop (30 = Active OFF, 1030 = Active ON) (STOP)				N	Y	Y		
		32 (1032): Pre-excitation (EXITE)				N	Y	Y		
		33 (1033): Reset PID integral and differential components (PID-RST)				Y	Y	Y		
		34 (1034): Hold PID integral component (PID-HLD)				Y	Y	Y		
		35 (1035): Select local (keypad) operation (LOC)				Y	Y	Y		
		36 (1036): Select motor 3 (M3)				Y	Y	Y		
		37 (1037): Select motor 4 (M4)				Y	Y	Y		
		39: Protect motor from dew condensation (DWP)				Y	Y	Y		
		40: Enable integrated sequence to switch to commercial power (50 Hz) (ISW50)				Y	N	N		
		41: Enable integrated sequence to switch to commercial power (60 Hz) (ISW60)				Y	N	N		
		47 (1047): Servo-lock command (LOCK)				N	N	Y		
		49 (1049): Pulse train sign (SIGN)				Y	Y	Y		
		70 (1070): Cancel constant peripheral speed control (Hz/LSC)				Y	Y	Y		
		71 (1071): Hold the constant peripheral speed control frequency in the memory (LSC-HLD)				Y	Y	Y		
		72 (1072): Count the run time of commercial power-driven motor 1 (CRUN-M1)				Y	N	N		
		73 (1073): Count the run time of commercial power-driven motor 2 (CRUN-M2)				Y	N	N		
		74 (1074): Count the run time of commercial power-driven motor 3 (CRUN-M3)				Y	N	N		
		75 (1075): Count the run time of commercial power-driven motor 4 (CRUN-M4)				Y	N	N		
		76 (1076): Select droop control (DROOP)				Y	Y	Y		
		77 (1077): Cancel PG alarm (PG-CCL)				N	N	Y		
		81 (1081): Clear all customizable logic timers (CLTC)				Y	Y	Y		
		98: Run forward (FWD)				Y	Y	Y		
		99: Run reverse (REV)				Y	Y	Y		
		100: No function assigned (NONE)				Y	Y	Y		
		Setting the value of 1000s in parentheses () shown above assigns a negative logic input to a terminal.								
		<u>U91</u>	Customizable Logic Timer Monitor (Step selection)	1 : Step 1 2 : Step 2 3 : Step 3 4 : Step 4 5 : Step 5 6 : Step 6 7 : Step 7 8 : Step 8 9 : Step 9 10 : Step 10	N	Y	1	Y	Y	Y

Function Settings

●y codes: LINK Functions

Code	Name	Data setting range	Change when running	Data copying	Default setting	Drive control		
						V/f	w/o PG	w/ PG
401 402	RS-485 Communication 1 (Station address) (Communications error processing)	1 to 255 0 : Immediately trip with alarm <i>E-rB</i> 1 : Trip with alarm <i>E-rB</i> after running for the period specified by timer y03 2 : Retry during the period specified by timer y03. If the retry fails, trip with alarm <i>E-rB</i> . If it succeeds, continue to run. 3 : Continue to run	N Y	Y Y	1 0	Y Y	Y Y	Y Y
403 404	(Timer) (Baud rate)	0.0 to 60.0 s 0 : 2400 bps 1 : 4800 bps 2 : 9600 bps 3 : 19200 bps 4 : 38400 bps	Y Y	Y Y	2.0 3	Y Y	Y Y	Y Y
405 406	(Data length) (Parity check)	0 : 8 bits 1 : 7 bits 0 : None (2 stop bits) 1 : Even parity (1 stop bit) 2 : Odd parity (1 stop bit) 3 : None (1 stop bit)	Y Y	Y Y	0 0	Y Y	Y Y	Y Y
407 408	(Stop bits) RS-485 Communication 1 (No-response error detection time)	0 : 2 bits 1 : 1 bit 0 : No detection; 1 to 60 s	Y Y	Y Y	0 0	Y Y	Y Y	Y Y
409 410	(Response interval) (Protocol selection)	0.00 to 1.00 s 0 : Modbus RTU protocol 1 : FRENIC Loader protocol (SX protocol) 2 : Fuji general-purpose inverter protocol	Y Y	Y Y	0.01 1	Y Y	Y Y	Y Y
411 412	RS-485 Communication 2 (Station address) (Communications error processing)	1 to 255 0 : Immediately trip with alarm <i>E-rP</i> 1 : Trip with alarm <i>E-rP</i> after running for the period specified by timer y13 2 : Retry during the period specified by timer y13. If the retry fails, trip with alarm <i>E-rP</i> . If it succeeds, continue to run. 3 : Continue to run	N Y	Y Y	1 0	Y Y	Y Y	Y Y
413 414	(Timer) (Baud rate)	0.0 to 60.0 s 0 : 2400 bps 1 : 4800 bps 2 : 9600 bps 3 : 19200 bps 4 : 38400 bps	Y Y	Y Y	2.0 3	Y Y	Y Y	Y Y
415 416	(Data length) (Parity check)	0 : 8 bits 1 : 7 bits 0 : None (2 stop bits) 1 : Even parity (1 stop bit) 2 : Odd parity (1 stop bit) 3 : None (1 stop bit)	Y Y	Y Y	0 0	Y Y	Y Y	Y Y
417 418	(Stop bits) (No-response error detection time)	0 : 2 bits 1 : 1 bit 0 : No detection; 1 to 60 s	Y Y	Y Y	0 0	Y Y	Y Y	Y Y
419 420	(Response interval) (Protocol selection)	0.00 to 1.00 s 0 : Modbus RTU protocol 2 : Fuji general-purpose inverter protocol	Y Y	Y Y	0.01 0	Y Y	Y Y	Y Y
497	Communication Data Storage Selection	0 : Save into nonvolatile storage (Rewritable times limited) 1 : Write into temporary storage (Rewritable times unlimited) 2 : Save all data from temporary storage to nonvolatile one (After saving data, the y97 data automatically returns to "1.")	Y	Y	0	Y	Y	Y
498	Bus Link Function (Mode selection)	Frequency command Run command 0 : Follow H30 data Follow H30 data 1 : Via fieldbus option Follow H30 data 2 : Follow H30 data Via fieldbus option 3 : Via fieldbus option Via fieldbus option	Y	Y	0	Y	Y	Y
499	Loader Link Function (Mode selection)	Frequency command Run command 0 : Follow H30 and y98 data Follow H30 and y98 data 1 : Via RS-485 link Follow H30 and y98 data (FRENIC Loader) 2 : Follow H30 and y98 data Via RS-485 link (FRENIC Loader) 3 : Via RS-485 link Via RS-485 link (FRENIC Loader) (FRENIC Loader)	Y	N	0	Y	Y	Y

■ Changing, validating, and saving function code data when the inverter is running

Function codes are indicated by the following based on whether they can be changed or not when the inverter is running:

Notation	Change when running	Validating and saving function code data
Y*	Possible	If the data of the codes marked with Y* is changed with and keys, the change will immediately take effect; however, the change is not saved into the inverter's memory. To save the change, press the key. If you press the key without pressing the key to exit the current state, then the changed data will be discarded and the previous data will take effect for the inverter operation.
Y	Possible	Even if the data of the codes marked with Y is changed with and keys, the change will not take effect. Pressing the key will make the change take effect and save it into the inverter's memory.
N	Impossible	—

■ Copying data

The keypad is capable of copying of the function code data stored in the inverter's memory into the keypad's memory (refer to Menu #7 "Data copying" in Programming mode). With this feature, you can easily transfer the data saved in a source inverter to other destination inverters.

If the specifications of the source and destination inverters differ, some code data may not be copied to ensure safe operation of your power system.

Whether data will be copied or not is detailed with the following symbols in the "Data copying" column of the function code tables given on the following pages.

Y: Will be copied unconditionally.

Y1: Will not be copied if the rated capacity differs from the source inverter.

Y2: Will not be copied if the rated input voltage differs from the source inverter.

N: Will not be copied. (The function code marked with "N" is not subject to the Verify operation, either.)

For details of copying operation, refer to Chapter 3, Section 3.4.9.

External Dimensions (Standard Inverter)

40Hp (LD) & Below

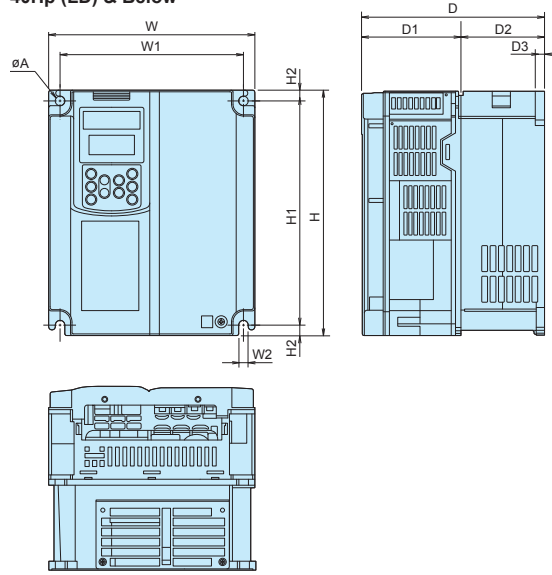

50Hp (LD) & Above

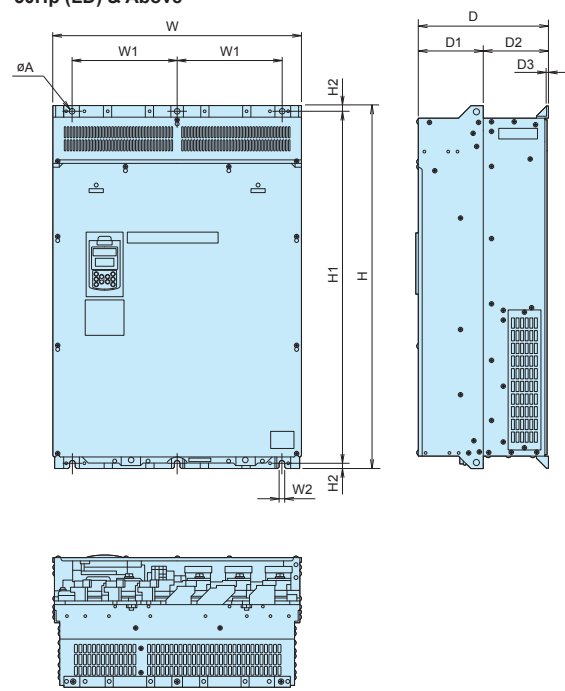

Inverter type		Dimensions inch (mm)											
FRN□□□G1S-2U/4U		W	W1	W2	H	H1	H2	D	D1	D2	D3	∅A	
230 V	460 V												
0.5	0.5	4.33 (110)	3.78 (96)	0.24 (6)		9.69 (246)	0.28 (7)	5.2 (132)	4.45 (113)	0.75 (19)	0.12 (3)	0.24 (6)	
1	1	5.91 (150)	5.35 (136)					10.24 (260)		9.37 (238)			7.68 (195)
2	2			9.84 (250)	8.9 (226)	15.75 (400)	14.88 (378)		0.43 (11)		10.04 (255)	5.51 (140)	
3	3	12.6 (320)	9.45 (240)					21.65 (550)		20.87 (530)			10.63 (270)
5	5			13.98 (355)	10.83 (275)	24.21 (615)	23.43 (595)		0.47 (12)		11.22 (285)	5.71 (145)	
7.5	7.5	20.87 (530)	16.93 (430)					29.53 (750)		28.35 (720)			0.61 (15.5)
10	10			20.87 (530)	16.93 (430)	29.53 (750)	34.65 (880)		33.46 (850)		14.17 (360)	7.09 (180)	
15	15	20.87 (530)	16.93 (430)					29.53 (750)		29.13 (740)			27.95 (710)
20	20			20.87 (530)	16.93 (430)	29.53 (750)	39.37 (1000)		38.19 (970)		14.17 (360)	7.09 (180)	
25	25	26.77 (680)	11.42 (290)					0.59 (15)		55.12 (1400)			53.94 (1370)
30	30			34.65 (880)	10.24 (260)	61.02 (1550)	59.84 (1520)		19.69 (500)		12.33 (313.2)	7.35 (186.8)	
40	40	39.37 (1000)	11.81 (300)					0.59 (15)		61.02 (1550)			59.84 (1520)
50	50			39.37 (1000)	11.81 (300)	0.59 (15)	61.02 (1550)		59.84 (1520)		19.69 (500)	12.33 (313.2)	
60	75	39.37 (1000)	11.81 (300)					0.59 (15)		61.02 (1550)			59.84 (1520)
-	100			39.37 (1000)	11.81 (300)	0.59 (15)	61.02 (1550)		59.84 (1520)		19.69 (500)	12.33 (313.2)	
75	125	39.37 (1000)	11.81 (300)					0.59 (15)		61.02 (1550)			59.84 (1520)
100	-			39.37 (1000)	11.81 (300)	0.59 (15)	61.02 (1550)		59.84 (1520)		19.69 (500)	12.33 (313.2)	
125	-	39.37 (1000)	11.81 (300)					0.59 (15)		61.02 (1550)			59.84 (1520)
150	-			39.37 (1000)	11.81 (300)	0.59 (15)	61.02 (1550)		59.84 (1520)		19.69 (500)	12.33 (313.2)	
-	150	39.37 (1000)	11.81 (300)					0.59 (15)		61.02 (1550)			59.84 (1520)
-	200			39.37 (1000)	11.81 (300)	0.59 (15)	61.02 (1550)		59.84 (1520)		19.69 (500)	12.33 (313.2)	
-	250	39.37 (1000)	11.81 (300)					0.59 (15)		61.02 (1550)			59.84 (1520)
-	300			39.37 (1000)	11.81 (300)	0.59 (15)	61.02 (1550)		59.84 (1520)		19.69 (500)	12.33 (313.2)	
-	350	39.37 (1000)	11.81 (300)					0.59 (15)		61.02 (1550)			59.84 (1520)
-	450			39.37 (1000)	11.81 (300)	0.59 (15)	61.02 (1550)		59.84 (1520)		19.69 (500)	12.33 (313.2)	
-	500	39.37 (1000)	11.81 (300)					0.59 (15)		61.02 (1550)			59.84 (1520)
-	600			39.37 (1000)	11.81 (300)	0.59 (15)	61.02 (1550)		59.84 (1520)		19.69 (500)	12.33 (313.2)	
-	700	39.37 (1000)	11.81 (300)					0.59 (15)		61.02 (1550)			59.84 (1520)
-	800			39.37 (1000)	11.81 (300)	0.59 (15)	61.02 (1550)		59.84 (1520)		19.69 (500)	12.33 (313.2)	
-	900	39.37 (1000)	11.81 (300)					0.59 (15)		61.02 (1550)			59.84 (1520)
-	1000			39.37 (1000)	11.81 (300)	0.59 (15)	61.02 (1550)		59.84 (1520)		19.69 (500)	12.33 (313.2)	

- Characteristics
- Model Variations
- Keypad Functionality
- Inverter PC Softw
- Standard Specifications
- Common Specifications
- Basic Wiring Diagram
- Terminal Functions
- Function Settings
- External Dimensions
- Options
- Reference material
- Warranty

External Dimensions (Keypad)

●Standard Keypad (NEMA4/12 rated for panel door/ remote mount) TP-G1W-J1

[Unit: inch(mm)]

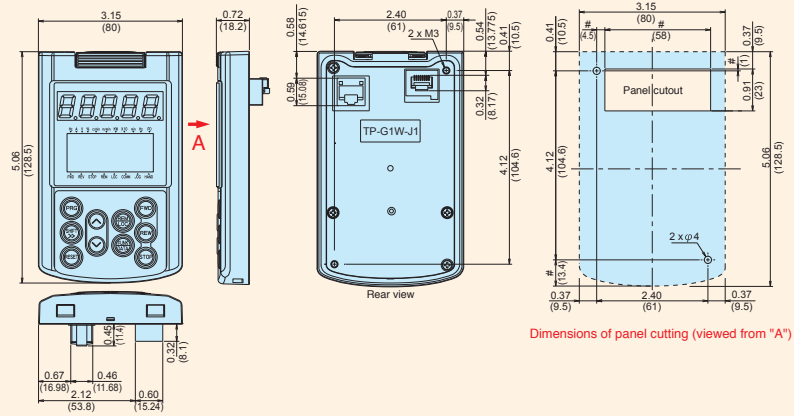

●Keypad (with USB Port) TP-E1U (Optional)

[Unit: inch(mm)]

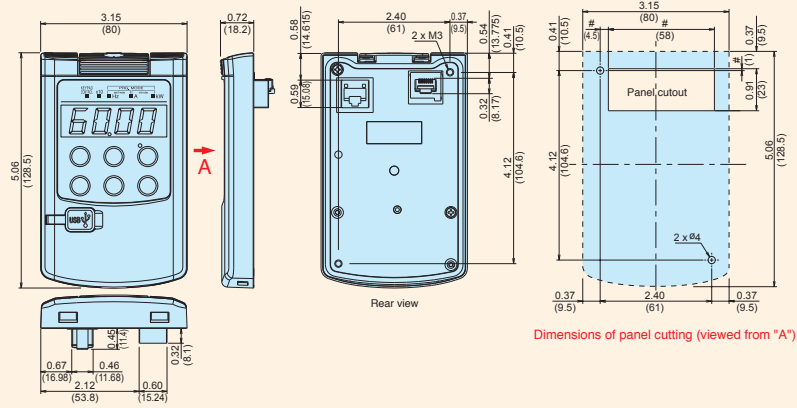

Options

DC REACTOR



Figure A

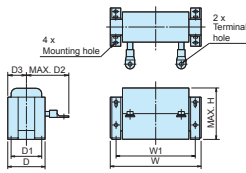

Figure B

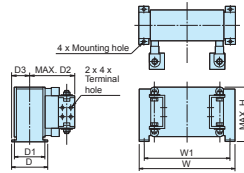
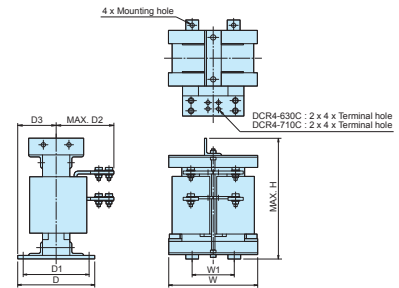

Figure C



Power supply voltage	Inverter type FRN-□□GIS -2U/4U	Option/ Standard	Reactor	Refer to:	Dimensions inch (mm)										Mass lb (kg)
					W	W1	D	D1	D2	D3	H	Mounting hole	Terminal hole		
230 V	100	Standard	DCR2-75C	Figure A	10,040.39 (25510)	8.86 (225)	4,170.08 (1062)	3.39 (86)	5.71 (145)	2,090.04 (531)	5.71 (145)	M6	M12	25 (11.4)	
	125		DCR2-90C				4,570.08 (1162)	3.78 (96)	6.1 (155)	2,280.04 (581)				31 (14)	
	150		DCR2-110C				4,570.08 (1162)	3.54 (90)	7.28 (185)					37 (17)	

Note: 100 HP or above type comes with a DC reactor (DCR) suitable for the LD-mode use

Power supply voltage	Inverter type FRN-□□GIS -2U/4U	Option/ Standard	Reactor	Refer to:	Dimensions inch (mm)										Mass lb (kg)
					W	W1	D	D1	D2	D3	H	Mounting hole	Terminal hole		
460 V	100	Standard	DCR4-75C	Figure A	10,040.39 (25510)	8.86 (225)	4,170.08 (1062)	3.39 (86)	4.92 (125)	2,090.04 (531)	5.71 (145)	M6	M12	27 (12.4)	
	125		DCR4-90C				4,570.08 (1162)	3.78 (96)	5.51 (140)	2,280.04 (581)				32 (14.7)	
	150		DCR4-110C				4,570.08 (1162)	3.54 (90)	6.89 (175)					41 (18.4)	
	200		DCR4-132C				4,960.16 (1264)	3.94 (100)	7.09 (180)	2,480.08 (632)				49 (23)	
	250		DCR4-160C				5,180.16 (1314)	4.06 (103)	7.87 (200)	2,590.08 (658)				56 (25.5)	
	300		DCR4-200C				5,550.16 (1414)	4.45 (113)	7.28 (185)	2,780.08 (70.52)				65 (29.5)	
	350		DCR4-220C	5,750.16 (1464)	4.65 (118)	7.87 (200)	2,870.08 (73.2)	72 (32.5)							
	450		DCR4-280C	6,340.16 (1614)	5.24 (133)	8.27 (210)	3,170.08 (80.52)	7.48 (190)	79 (36)						
	500		DCR4-355C	6,140.16 (1564)	5.04 (128)	7.87 (200)	3,070.08 (78.1)	8.86 (225)	104 (47)						
	600		DCR4-400C	5,710.16 (1454)	4.57 (117)	8.39 (213)	2,850.04 (72.51)	9.65 (245)	M10	115 (52)					
	700		DCR4-450C	5,910.16 (1504)	4.8 (122)	8.46 (215)	2,950.08 (75.2)			132 (60)					
	800		DCR4-500C	6,501.6 (1654)	5.39 (137)	8.66 (220)	3,250.08 (82.52)			154 (70)					
	900		DCR4-630C	5,710.16 (145)	4.57 (117)	6.69 (169)	2,850.04 (72.51)	18.9 (480)	M12	165 (75)					
	1000		DCR4-710C	11,220.39 (28510)	5.71 (145)	7.88 (200)	4,090.08 (104.2)			209 (95)					

Note: 100 HP or above type comes with a DC reactor (DCR) suitable for the LD-mode use

Braking unit and Braking resistor (standard item)

LD mode

Power supply voltage	Nominal applied motor (HP)	Inverter type	Option			
			Braking unit		Braking resistor	
LD mode			Type	Qty	Type	Qty
Three phase 230V	0.5	FRNF50G1S-2U			DB0.75-2C	1
	1	FRN001G1S-2U			DB2.2-2C	1
	2	FRN002G1S-2U			DB3.7-2C	1
	3	FRN003G1S-2U			DB5.5-2C	1
	5	FRN005G1S-2U			DB7.5-2C	1
	7.5	FRN007G1S-2U			DB11-2C	1
	10	FRN010G1S-2U			DB15-2C	1
	15	FRN015G1S-2U			DB22-2C	1
	20	FRN020G1S-2U				
	25	FRN025G1S-2U				
	30	FRN030G1S-2U				
	40	FRN040G1S-2U				
	50	FRN050G1S-2U	BU37-2C	1	DB30-2C	1
	60	FRN060G1S-2U			DB37-2C	1
	75	FRN075G1S-2U	BU55-2C	1	DB45-2C	1
100	FRN100G1S-2U			DB55-2C	1	
125	FRN125G1S-2U			DB75-2C	1	
150	FRN150G1S-2U	BU90-2C	1	DB110-2C	1	
Three phase 460V	0.5	FRNF50G1S-4U			DB0.75-4C	1
	1	FRN001G1S-4U			DB2.2-4C	1
	2	FRN002G1S-4U			DB3.7-4C	1
	3	FRN003G1S-4U			DB5.5-4C	1
	5	FRN005G1S-4U			DB7.5-4C	1
	7.5	FRN007G1S-4U			DB11-4C	1
	10	FRN010G1S-4U			DB15-4C	1
	15	FRN015G1S-4U			DB22-4C	1
	20	FRN020G1S-4U				
	25	FRN025G1S-4U				
	30	FRN030G1S-4U				
	40	FRN040G1S-4U				
	50	FRN050G1S-4U	BU37-4C	1	DB30-4C	1
	60	FRN060G1S-4U			DB37-4C	1
	75	FRN075G1S-4U	BU55-4C	1	DB45-4C	1
100	FRN100G1S-4U			DB55-4C	1	
125	FRN125G1S-4U	BU90-4C	1	DB75-4C	1	
150	FRN150G1S-4U			DB110-4C	1	
200	FRN200G1S-4U	BU132-4C	1	DB132-4C	1	
250	FRN250G1S-4U			DB160-4C	1	
300	FRN300G1S-4U			DB200-4C	1	
350	FRN350G1S-4U			DB220-4C	1	
450	FRN450G1S-4U					
500	FRN500G1S-4U					
600	FRN600G1S-4U	BU220-4C	2	DB160-4C	2	
700	FRN700G1S-4U					
800	FRN800G1S-4U			DB200-4C		
900	FRN900G1S-4U					
1000	FRN1000G1S-4U			DB220-4C	3	

MD mode

Power supply voltage	Nominal applied motor (HP)	Inverter type	Option			
			Braking unit		Braking resistor	
LD mode			Type	Qty	Type	Qty
Three phase 460V	150	FRN150G1S-4U	BU132-4C		DB110-4C	
	200	FRN200G1S-4U			DB132-4C	
	250	FRN250G1S-4U	BU220-4C	1	DB160-4C	1
	300	FRN300G1S-4U			DB200-4C	
	350	FRN350G1S-4U			DB220-4C	
	350	FRN450G1S-4U	BU132-4C		DB132-4C	
	450	FRN500G1S-4U			DB160-4C	2
	500	FRN600G1S-4U	BU220-4C	2	DB200-4C	
	600	FRN700G1S-4U				
700	FRN800G1S-4U		3	DB160-4C	3	

HD mode

Power supply voltage	Nominal applied motor (HP)	Inverter type	Option			
			Braking unit		Braking resistor	
HD mode			Type	Qty	Type	Qty
Three phase 230V	0.5	FRNF50G1S-2U			DB0.75-2C	1
	1	FRN001G1S-2U			DB2.2-2C	1
	2	FRN002G1S-2U			DB3.7-2C	1
	3	FRN003G1S-2U			DB5.5-2C	1
	5	FRN005G1S-2U			DB7.5-2C	1
	7.5	FRN007G1S-2U			DB11-2C	1
	10	FRN010G1S-2U			DB15-2C	1
	15	FRN015G1S-2U			DB22-2C	1
	20	FRN020G1S-2U				
	25	FRN025G1S-2U				
	30	FRN030G1S-2U				
	40	FRN040G1S-2U				
	50	FRN050G1S-2U	BU37-2C	1	DB30-2C	1
	60	FRN060G1S-2U			DB37-2C	1
	75	FRN075G1S-2U	BU55-2C	1	DB45-2C	1
100	FRN100G1S-2U			DB55-2C	1	
125	FRN125G1S-2U	BU90-2C	1	DB75-2C	1	
150	FRN150G1S-2U			DB110-2C	1	
Three phase 460V	0.5	FRNF50G1S-4U			DB0.75-4C	1
	1	FRN001G1S-4U			DB2.2-4C	1
	2	FRN002G1S-4U			DB3.7-4C	1
	3	FRN003G1S-4U			DB5.5-4C	1
	5	FRN005G1S-4U			DB7.5-4C	1
	7.5	FRN007G1S-4U			DB11-4C	1
	10	FRN010G1S-4U			DB15-4C	1
	15	FRN015G1S-4U			DB22-4C	1
	20	FRN020G1S-4U				
	25	FRN025G1S-4U				
	30	FRN030G1S-4U				
	40	FRN040G1S-4U				
	50	FRN050G1S-4U	BU37-4C	1	DB30-4C	1
	60	FRN060G1S-4U			DB37-4C	1
	75	FRN075G1S-4U	BU55-4C	1	DB45-4C	1
100	FRN100G1S-4U			DB55-4C	1	
125	FRN125G1S-4U	BU90-4C	1	DB75-4C	1	
150	FRN150G1S-4U			DB110-4C	1	
200	FRN200G1S-4U	BU132-4C	1	DB132-4C	1	
250	FRN250G1S-4U			DB160-4C	1	
300	FRN300G1S-4U			DB200-4C	1	
350	FRN350G1S-4U			DB220-4C	1	
450	FRN450G1S-4U					
500	FRN500G1S-4U					
600	FRN600G1S-4U	BU220-4C	2	DB160-4C	2	
700	FRN700G1S-4U					
800	FRN800G1S-4U			DB200-4C		
900	FRN900G1S-4U					
1000	FRN1000G1S-4U		3	DB220-4C	3	

Other Options

Other options

Parts name	Type	Remarks
EtherNet card	OPC-G1-ETH	The Ethernet option card allows for connectivity to various Ethernet protocols. These include: - EtherNet/IP - Modbus/TCP - BACnet/IP - Profinet-IO The card also contains an embedded web server for configuration of numerous additional functions such as alarm evaluation with email notification, dashboard GUI with multiple windows for monitoring, virtual keypad interface, and protocol configuration.
DeviceNet card	OPC-G1-DEV	The DeviceNet option card allows for connectivity to a DeviceNet network. The card allows for control or monitoring of the inverter, monitor and change function codes, and the use of explicit messaging. The following are specifications for the DeviceNet options. - 64 Nodes, maximum, including the Master device. - Data Rate (baud rate): 125 kbps, 250 kbps, 500 kbps - I/O Message: Polling and Change of State supported - Applicable Profile: AC Drive profile - Reading and writing all the function codes applicable to the FRENIC-MEGA (I/O Message (User Defined Assembly Instance or Access to Function Codes Instance) and Explicit Message) This product has been tested by ODVA authorized Independent Test Lab and found to comply with ODVA's DeviceNet Conformance Test Version 20.
CC-link card	OPC-G1-CCL	The CC-Link option card allows for connectivity to a CC-Link network. The card allows for control or monitoring of the inverter and for monitoring and changing of function codes. The following are specifications for the CC-Link option. - CC-Link Version: Complies with CC-Link versions 1.10 and 2.00 - Applicable Profile: Inverter (1 station occupied) - Monitoring the status of the FRENIC-MEGA (running status, frequency, output torque, output current, output voltage, etc.) - Reading and writing from/to function codes applicable to the FRENIC-MEGA
PROFIBUS DP card	OPC-G1-PDP	The Profibus-DP option card allows for connectivity to a Profibus network. The card allows for control or monitoring of the inverter and for monitoring and changing of function codes. The following are specifications for the Profibus option. - PROFIBUS version: DP-V0 compliant - Transmission speed: 9,600 bps to 12 Mbps - Maximum network cable length per segment: 100 m (12 Mbps) to 1200 m (9.6 kbps) - Applicable Profile: PROFIDrive V2 compliant
CANopen	OPC-G1-COP	The CANopen is the card which supports various open bus types. With this card, the following operations can be performed using PC or PLC. - Operation frequency setting - Operation command setting (FWD, REV, RET, etc.) - Data code setting for each function code - Reading trip data
T-link interface card	OPC-G1-TL	Up to 12 inverters can be connected by connecting the Fuji's PLC and the inverter via T-link (I/O transmission). - Operation frequency setting - Operation command setting (FWD, REV, RET, etc.)
PG interface card (supporting 12V)	OPC-G1-PG	Having this card built-in to the inverter allows the speed control and the position control.
PG interface card (supporting 5V)	OPC-G1-PG2	Having this card built-in to the inverter allows the speed control and the position control.
PG Synchronization Card	OPC-G1-PG22	Velocity synchronization card, allowing both master and slave encoder inputs.
Digital input interface card	OPC-G1-DI	Using this card allows frequency setting by 8, 12, 15, and 16 bits, and by BCD code.
Digital output interface card	OPC-G1-DO	The output interface card to be equipped with FRENIC-MEGA, which allows monitoring frequency, output voltage, and output current with binary code.
Analog input/output interface card	OPC-G1-AIO	Using this card allows the torque limit value input, frequency and frequency ratio setting with analog input.
Relay output card	OPC-G1-RY	Using this card allows relay output of the inverter general output signal (transistor output).

NEMA1 Cover NEMA1-□G1-□

NEMA1 kit, when fitted to the FRENIC-MEGA series, protects the inverter body with the structure that conforms to the NEMA1 standard (approved as UL TYPE1).

Power supply voltage	Inverter type	NEMA1 model number	Power supply voltage	Inverter type	NEMA1 model number
Three phase 230V	FRNF50G1S-2U	NEMA1-0.4G1-24	Three phase 460V	FRNF50G1S-4U	NEMA1-0.4G1-24
	FRN001G1S-2U	NEMA1-0.75G1-24		FRN001G1S-4U	NEMA1-0.75G1-24
	FRN002G1S-2U	NEMA1-3.7G1-24		FRN002G1S-4U	NEMA1-3.7G1-24
	FRN003G1S-2U	NEMA1-3.7G1-24		FRN003G1S-4U	NEMA1-3.7G1-24
	FRN005G1S-2U	NEMA1-3.7G1-24		FRN005G1S-4U	NEMA1-3.7G1-24
	FRN007G1S-2U	NEMA1-11G1-24		FRN007G1S-4U	NEMA1-11G1-24
	FRN010G1S-2U	NEMA1-11G1-24		FRN010G1S-4U	NEMA1-11G1-24
	FRN015G1S-2U	NEMA1-11G1-24		FRN015G1S-4U	NEMA1-11G1-24
	FRN020G1S-2U	NEMA1-11G1-24		FRN020G1S-4U	NEMA1-11G1-24
	FRN025G1S-2U	NEMA1-22G1-24		FRN025G1S-4U	NEMA1-22G1-24
	FRN030G1S-2U	NEMA1-22G1-24		FRN030G1S-4U	NEMA1-22G1-24
	FRN040G1S-2U	NEMA1-22G1-2		FRN040G1S-4U	NEMA1-22G1-24
	FRN050G1S-2U	NEMA1-37G1-24		FRN050G1S-4U	NEMA1-37G1-24
	FRN060G1S-2U	NEMA1-75G1-24		FRN060G1S-4U	NEMA1-37G1-24
	FRN075G1S-2U	NEMA1-75G1-24		FRN075G1S-4U	NEMA1-75G1-24
FRN100G1S-2U	NEMA1-75G1-24	FRN100G1S-4U	NEMA1-75G1-24		
FRN125G1S-2U	NEMA1-75G1-2	FRN125G1S-4U	NEMA1-75G1-24		
FRN150G1S-2U	NEMA1-220G1-24	FRN150G1S-4U	NEMA1-110G1-4		
			FRN200G1S-4U	NEMA1-110G1-4	
			FRN250G1S-4U	NEMA1-160G1-4	
			FRN300G1S-4U	NEMA1-160G1-4	
			FRN350G1S-4U	NEMA1-220G1-24	
			FRN450G1S-4U	NEMA1-220G1-24	
			FRN500G1S-4U	NEMA1-315G1-4	
			FRN600G1S-4U	NEMA1-315G1-4	
			FRN700G1S-4U	NEMA1-400G1-4	
			FRN800G1S-4U	NEMA1-400G1-4	
			FRN900G1S-4U	NEMA1-630G1-4	
			FRN1000G1S-4U	NEMA1-630G1-4	

Restrictions on mounting an optional card

Y: Available N: Not Available

Mounting port	OPC-G1S-□□			
	PG, PG2, PG22	DI, DO, AIO, DEV	RY	ETH, TL, COP, PDP, CCL, SX
C PORT	Y	Y	N	N
B PORT	N	Y	Y	N
A PORT	N	Y	Y	Y
Remarks	※1	※2	※3	※2

*1 Any one of the above can be mounted on only C port.

*2 Only one card can be mounted on any of A, B, or C ports.

Cards can be mounted on DI, DO, and AIO ports at the same time, however, two identical cards cannot be allowed.

*3 The cards can be mounted on both A and B ports.

Two RY cards can be mounted at the same time.

The number of RY contact points of a card is two. If three or four points are necessary, prepare two cards.

Note: There are also restrictions on mounting when using the optional communications card. Contact us for details.

Note: When mounting the NEMA option, only one optional card can be mounted. (RY card allows mounting of two cards.)

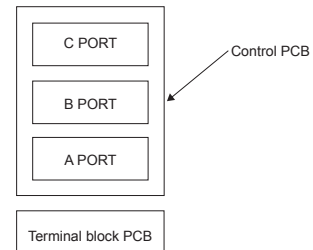

Reference material

Reference material

● Low motor noise operation

The inverter can be operated continuously at rated current with a carrier frequency setting of 16kHz. Thus, operating with lower motor noise can be achieved without de-rating the inverter output current as compared to other manufacturers.

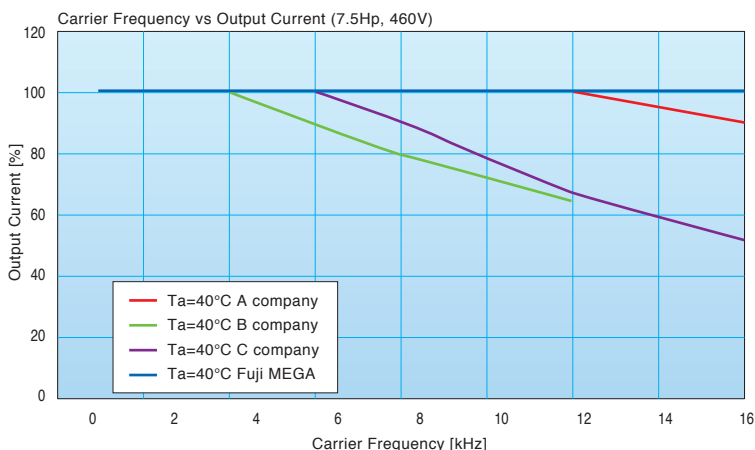

● Quick reference for inverter rated current

Power supply voltage	Inverter type	Applied Motor [HP]			Rated current [A]			Overload capability, others		
		LD	MD	HD	LD	MD	HD	LD	MD	HD
Three phase 230V	FRNF50G1S-2U	0.5	-	0.5	3	-	3			
	FRN001G1S-2U	1	-	1	5	-	5			
	FRN002G1S-2U	2	-	2	8	-	8			
	FRN003G1S-2U	3	-	3	11	-	11			
	FRN005G1S-2U	5	-	5	18	-	18			
	FRN007G1S-2U	7.5	-	7.5	27	-	27			
	FRN010G1S-2U	10	-	7.5	31.8	-	27			
	FRN015G1S-2U	15	-	10	46.2	-	37			
	FRN020G1S-2U	20	-	15	59.4	-	49			
	FRN025G1S-2U	25	-	20	74.8	-	63			
	FRN030G1S-2U	30	-	25	88	-	76			
	FRN040G1S-2U	40	-	30	115	-	90			
	FRN050G1S-2U	50	-	40	146	-	119			
	FRN060G1S-2U	60	-	50	180	-	146			
	FRN075G1S-2U	75	-	60	215	-	180			
Three phase 460V	FRN100G1S-2U	100	-	75	283	-	215	120% 1min.	150% 1min.	150% 1min. 200% 3s
	FRN125G1S-2U	125	-	100	346	-	283			
	FRN150G1S-2U	150	-	125	415	-	346			
	FRNF50G1S-4U	0.5	-	0.5	1.5	-	1.5			
	FRN001G1S-4U	1	-	1	2.5	-	2.5			
	FRN002G1S-4U	2	-	2	4	-	4			
	FRN003G1S-4U	3	-	3	5.5	-	5.5			
	FRN005G1S-4U	5	-	5	9	-	9			
	FRN007G1S-4U	7.5	-	7.5	13.5	-	13.5			
	FRN010G1S-4U	10	-	7.5	16.5	-	13.5			
	FRN015G1S-4U	15	-	10	23	-	18.5			
	FRN020G1S-4U	20	-	15	30.5	-	24.5			
	FRN025G1S-4U	25	-	20	37	-	32			
	FRN030G1S-4U	30	-	25	45	-	39			
	FRN040G1S-4U	40	-	30	60	-	45			
	FRN050G1S-4U	50	-	40	75	-	60			
	FRN060G1S-4U	60	-	50	91	-	75			
	FRN075G1S-4U	75	-	60	112	-	91			
	FRN100G1S-4U	100	-	75	150	-	112			
	FRN125G1S-4U	125	-	100	176	-	150			
	FRN150G1S-4U	150	150	125	210	210	176			
	FRN200G1S-4U	200	200	150	253	253	210			
	FRN250G1S-4U	250	250	200	304	304	253			
	FRN300G1S-4U	300	300	250	377	377	304			
	FRN350G1S-4U	350	350	300	415	415	377			
	FRN450G1S-4U	450	350	350	520	468	415			
	FRN500G1S-4U	500	450	400	650	585	520			
	FRN600G1S-4U	600	500	450	740	650	585			
	FRN700G1S-4U	700	600	500	840	740	650			
	FRN800G1S-4U	800	700	600	960	840	740			
FRN900G1S-4U	900	-	800	1170	-	960				
FRN1000G1S-4U	1000	-	900	1370	-	1170				

fc = carrier frequency
fo = frequency output

Characteristics

Model Variations

keypad Functionality

Inverter PC Softw

Standard Specifications

Common Specifications

Basic Wiring Diagram

Terminal Functions

Function Settings

External Dimensions

Options

Reference material

Warranty

To all our customers who purchase Fuji Electric products included in this catalog:

Please take the following items into consideration when placing your order.

When requesting an estimate and placing your orders for the products included in these materials, please be aware that any items such as specifications which are not specifically mentioned in the contract, catalog, specifications or other materials will be as mentioned below.

In addition, the products included in these materials are limited in the use they are put to and the place where they can be used, etc., and may require periodic inspection. Please confirm these points with your sales representative or directly with this company.

Furthermore, regarding purchased products and delivered products, we request that you take adequate consideration of the necessity of rapid receiving inspections and of product management and maintenance even before receiving your products.

1. Free of Charge Warranty Period and Warranty Range

1-1 Free of charge warranty period

- (1) The product warranty period is "Three years from shipment"
- (2) However, in cases where the use environment, conditions of use, use frequency and times used, etc., have an effect on product life, this warranty period may not apply.
- (3) Furthermore, the warranty period for parts restored by Fuji Electric's Service Department is "6 months from the date that repairs are completed."

1-2 Warranty range

- (1) In the event that breakdown occurs during the product's warranty period which is the responsibility of Fuji Electric, Fuji Electric will replace or repair the part of the product that has broken down free of charge at the place where the product was purchased or where it was delivered. However, if the following cases are applicable, the terms of this warranty may not apply.
 - 1) The breakdown was caused by inappropriate conditions, environment, handling or use methods, etc. which are not specified in the catalog, operation manual, specifications or other relevant documents.
 - 2) The breakdown was caused by the product other than the purchased or delivered Fuji's product.
 - 3) The breakdown was caused by the product other than Fuji's product, such as the customer's equipment or software design, etc.
 - 4) Concerning the Fuji's programmable products, the breakdown was caused by a program other than a program supplied by this company, or the results from using such a program.
 - 5) The breakdown was caused by modifications or repairs affected by a party other than Fuji Electric.
 - 6) The breakdown was caused by improper maintenance or replacement using consumables, etc. specified in the operation manual or catalog, etc.
 - 7) The breakdown was caused by a chemical or technical problem that was not foreseen when making practical application of the product at the time it was purchased or delivered.
 - 8) The product was not used in the manner the product was originally intended to be used.
 - 9) The breakdown was caused by a reason which is not this company's responsibility, such as lightning or other disaster.
- (2) Furthermore, the warranty specified herein shall be limited to the purchased or delivered product alone.
- (3) The upper limit for the warranty range shall be as specified in item (1) above and any damages (damage to or loss of machinery or equipment, or lost profits from the same, etc.) consequent to or resulting from breakdown of the purchased or delivered product shall be excluded from coverage by this warranty.

1-3. Trouble diagnosis

As a rule, the customer is requested to carry out a preliminary trouble diagnosis. However, at the customer's request, this company or its service network can perform the trouble diagnosis on a chargeable basis. In this case, the customer is asked to assume the burden for charges levied in accordance with this company's fee schedule.

2. Exclusion of Liability for Loss of Opportunity, etc.

Regardless of whether a breakdown occurs during or after the free of charge warranty period, this company shall not be liable for any loss of opportunity, loss of profits, or damages arising from special circumstances, secondary damages, accident compensation to another company, or damages to products other than this company's products, whether foreseen or not by this company, which this company is not be responsible for causing.

3. Repair Period after Production Stop, Spare Parts Supply Period (Holding Period)

Concerning models (products) which have gone out of production, this company will perform repairs for a period of 7 years after production stop, counting from the month and year when the production stop occurs. In addition, we will continue to supply the spare parts required for repairs for a period of 7 years, counting from the month and year when the production stop occurs. However, if it is estimated that the life cycle of certain electronic and other parts is short and it will be difficult to procure or produce those parts, there may be cases where it is difficult to provide repairs or supply spare parts even within this 7-year period. For details, please confirm at our company's business office or our service office.

4. Transfer Rights

In the case of standard products which do not include settings or adjustments in an application program, the products shall be transported to and transferred to the customer and this company shall not be responsible for local adjustments or trial operation.

5. Service Contents

The cost of purchased and delivered products does not include the cost of dispatching engineers or service costs. Depending on the request, these can be discussed separately.

6. Applicable Scope of Service

Above contents shall be assumed to apply to transactions and use of the country where you purchased the products. Consult the local supplier or Fuji for the detail separately.

Notes

Characteristics

Model Variations

Keypad Functionality

Inverter PC Software

Standard Specifications

Common Specifications

Basic Wiring Diagram

Terminal Functions

Function Settings

External Dimensions

Options

Reference material

Warranty

Notes

Characteristics

Model Variations

Keypad Functionality

Inverter PC Software

Standard Specifications

Common Specifications

Basic Wiring Diagram

Terminal Functions

Function Settings

External Dimensions

Options

Reference material

Warranty

● A complete and feature rich lineup of inverters from Fuji Electric.

Applications	Series Name (Catalog No.)	Features
General Industrial equipment	Compact inverter <i>FRENIC-Mini</i> (MEH530)	<ul style="list-style-type: none"> ● A frequency setting device is standard-equipped, making operation simple. ● Loaded with auto torque boost, current limiting, and slip compensation functions, all of which are ideal for controlling traverse conveyors. ● Loaded with the functions for auto energy saving operation and PID control, which are ideal for controlling fans and pumps
	Fan, pump inverter <i>FRENIC-Eco</i> (MEH532)	<ul style="list-style-type: none"> ● Developed exclusively for controlling variable torque load like fans and pumps. ● Full of new functions such as auto energy saving, PID control, life warning, and switching sequence to the commercial power supply. ● Ideal for air conditioners, fans, pumps, etc. which were difficult to use with conventional general-purpose inverters because of cost or functions.
	High performance, compact inverter <i>FRENIC-Multi</i> (MEH531)	<ul style="list-style-type: none"> ● The inverter featuring environment-friendly and long life design (10 years) complies with RoHS Directives (products manufactured beginning in the autumn of 2005). ● With expanded capacity range, abundant model variation, and simple and thorough maintenance, the Multi is usable for a wide range of applications. ● Equipped with the functions optimum for the operations specific to vertical and horizontal conveyance, such as hit-and-stop control, brake signal, torque limit, and current limit.
	High-performance, multi-functional inverter <i>FRENIC-MEGA</i> (MEH535)	Three-phase 460V: 0.5 to 1000HP, Three-phase 230V: 0.5 to 150HP <ul style="list-style-type: none"> ● Loaded with vector control which is the peak of general purpose inverters. ● Prepared three types; the Standard Inverter, Inverter with Built-in DC Reactor. ● Maintainability is further improved with built-in USB port(option). ● The short-time acceleration and deceleration become enabled with achieving better rating of overload ratings at HD spec: 200% for 3 sec and 150% for 1 min and at LD spec: 120% for 1 min

Consult the roman numeral numbered pages (starting with xii) in the FRENIC-MEGA Instruction Manual (INR-S147-1457). Requires derating of the drive. Select the Vfd based on the output amperate rating.



NOTES

When running general-purpose motors

• Driving a 400V general-purpose motor

When driving a 400V general-purpose motor with an inverter using extremely long cables, damage to the insulation of the motor may occur. Use an output circuit filter (OFL) if necessary after checking with the motor manufacturer. Fuji's motors do not require the use of output circuit filters because of their reinforced insulation.

• Torque characteristics and temperature rise

When the inverter is used to run a general-purpose motor, the temperature of the motor becomes higher than when it is operated using a commercial power supply. In the low-speed range, the cooling effect will be weakened, so decrease the output torque of the motor. If constant torque is required in the low-speed range, use a Fuji inverter motor or a motor equipped with an externally powered ventilating fan.

• Vibration

When the motor is mounted to a machine, resonance may be caused by the natural frequencies, including that of the machine. Operation of a 2-pole motor at 60Hz or more may cause abnormal vibration.

* Study use of tier coupling or dampening rubber.

* It is also recommended to use the inverter jump frequency control to avoid resonance points.

• Noise

When an inverter is used with a general-purpose motor, the motor noise level is higher than that with a commercial power supply. To reduce noise, raise carrier frequency of the inverter. High-speed operation at 60Hz or more can also result in more noise.

When running special motors

• High-speed motors

When driving a high-speed motor while setting the frequency higher than 120Hz, test the combination with another motor to confirm the safety of high-speed motors.

• Explosion-proof motors

When driving an explosion-proof motor with an inverter, use a combination of a motor and an inverter that has been approved in advance.

• Submersible motors and pumps

These motors have a larger rated current than general-purpose motors. Select an inverter whose rated output current is greater than that of the motor.

These motors differ from general-purpose motors in thermal characteristics. Set a low value in the thermal time constant of the motor when setting the electronic thermal facility.

• Brake motors

For motors equipped with parallel-connected brakes, their braking power must be supplied from the primary circuit (commercial power supply). If the brake power is connected to the inverter power output circuit (secondary circuit) by mistake, problems may occur.

Do not use inverters for driving motors equipped with series-connected brakes.

• Geared motors

If the power transmission mechanism uses an oil-

lubricated gearbox or speed changer/reducer, then continuous motor operation at low speed may cause poor lubrication. Avoid such operation.

• Synchronous motors

It is necessary to use software suitable for this motor type. Contact Fuji for details.

• Single-phase motors

Single-phase motors are not suitable for inverter-driven variable speed operation. Use three-phase motors.

* Even if a single-phase power supply is available, use a three-phase motor as the inverter provides three-phase output.

Environmental conditions

• Installation location

Use the inverter in a location with an ambient temperature range of -10 to 50°C.

The inverter and braking resistor surfaces become hot under certain operating conditions. Install the inverter on nonflammable material such as metal.

Ensure that the installation location meets the environmental conditions specified in "Environment" in inverter specifications.

Combination with peripheral devices

• Installing a molded case circuit breaker (MCCB)

Install a recommended molded case circuit breaker (MCCB) or an earth leakage circuit breaker (ELCB) in the primary circuit of each inverter to protect the wiring. Ensure that the circuit breaker capacity is equivalent to or lower than the recommended capacity.

• Installing a magnetic contactor (MC) in the output (secondary) circuit

If a magnetic contactor (MC) is mounted in the inverter's secondary circuit for switching the motor to commercial power or for any other purpose, ensure that both the inverter and the motor are fully stopped before you turn the MC on or off. Remove the surge killer integrated with the MC.

• Installing a magnetic contactor (MC) in the input (primary) circuit

Do not turn the magnetic contactor (MC) in the primary circuit on or off more than once an hour as an inverter fault may result. If frequent starts or stops are required during motor operation, use FWD/REV signals.

• Protecting the motor

The electronic thermal facility of the inverter can protect the motor. The operation level and the motor type (general-purpose motor, inverter motor) should be set. For high-speed motors or water-cooled motors, set a small value for the thermal time constant to protect the motor.

If you connect the motor thermal relay to the motor with a long cable, a high-frequency current may flow into the wiring stray capacitance. This may cause the relay to trip at a current lower than the set value for the thermal relay. If this happens, lower the carrier frequency or use the output circuit filter (OFL).

• Discontinuance of power-factor correcting capacitor

Do not mount power factor correcting capacitors in the inverter (primary) circuit. (Use the DC REACTOR to improve the inverter power factor.) Do

not use power factor correcting capacitors in the inverter output circuit (secondary). An overcurrent trip will occur, disabling motor operation.

• Discontinuance of surge killer

Do not mount surge killers in the inverter output (secondary) circuit.

• Reducing noise

Use of a filter and shielded wires are typical measures against noise to ensure that EMC Directives are met.

• Measures against surge currents

If an overvoltage trip occurs while the inverter is stopped or operated under a light load, it is assumed that the surge current is generated by open/close of the phase-advancing capacitor in the power system.

We recommend connecting a DC REACTOR to the inverter.

• Megger test

When checking the insulation resistance of the inverter, use a 500V megger and follow the instructions contained in the Instruction Manual.

Wiring

• Wiring distance of control circuit

When performing remote operation, use the twisted shield wire and limit the distance between the inverter and the control box to 20m.

• Wiring length between inverter and motor

If long wiring is used between the inverter and the motor, the inverter will overheat or trip as a result of overcurrent (high-frequency current flowing into the stray capacitance) in the wires connected to the phases. Ensure that the wiring is shorter than 50m. If this length must be exceeded, lower the carrier frequency or mount an output circuit filter (OFL).

• Wiring size

Select cables with a sufficient capacity by referring to the current value or recommended wire size.

• Wiring type

Do not use multicore cables that are normally used for connecting several inverters and motors.

• Grounding

Securely ground the inverter using the grounding terminal.

Selecting inverter capacity

• Driving general-purpose motor

Select an inverter according to the applicable motor ratings listed in the standard specifications table for the inverter. When high starting torque is required or quick acceleration or deceleration is required, select an inverter with a capacity one size greater than the standard.

• Driving special motors

Select an inverter that meets the following condition: Inverter rated current > Motor rated current.

Transportation and storage

When transporting or storing inverters, follow the procedures and select locations that meet the environmental conditions that agree with the inverter specifications.

Fuji Electric Corp. of America

47520 Westinghouse Drive Fremont, CA 94539

Tel. 510-440-1060

Fax. 510-440-1063

<http://www.americas.fujielectric.com>

MEH535a

Printed on recycled paper